



2012 Exhaust Product Guide

Nelson Global Products, Inc. offers the industry's best solutions for small engine exhaust. Using the latest design and manufacturing techniques, these products provide superior exhaust noise reduction and environmental protection. Original Equipment Manufacturers can count on these products for performance, durability and reliability.

Muffler Guide

Exhaust Accessories

Muffler Specifications

Cross References

Part Number Index



Nelson Global Products, Inc.

Warranty to the Original Equipment Manufacturer

Exhaust Products Limited Warranty

Warranty: This Warranty is provided to each original equipment manufacturer (OEM) with its purchase of any of the Nelson Global Products, Inc. products listed in the table below. Any Nelson Global Products, Inc. product determined by Nelson Global Products, Inc. to be defective in material or workmanship will, at Nelson Global Products, Inc. election, be replaced by another Nelson Global Products, Inc. product or by a credit for the original Nelson Global Products, Inc. selling price of the product. In the event that such a Nelson Global Products, Inc. product defect necessitates repair of the engine or components, Nelson Global Products, Inc. will reimburse the OEM reasonable costs to repair or replace, whichever is less, the damaged engine or components to a condition equivalent to that existing just prior to the failure.

Any claim under this Warranty for replacement or credit must be submitted in writing to Nelson Global Products, Inc. within thirty (30) days of discovering the claimed defect.

For the purpose of reviewing Warranty claim validity, Nelson Global Products, Inc. or its representatives will, at Nelson Global Products, Inc. discretion, have the right to:

- a. Physically inspect the claimed defective product and/or equipment using the product.
- b. Information available from purchaser or user relative to the actual application and/or use and maintenance of the product.

Duration: This Warranty extends from the in-service date of the Nelson Global Products, Inc. product installed by the original equipment manufacturer through the duration of the OEM's base warranty, but will not exceed the coverage period stated in the table below.

Limitation: Nelson Global Products, Inc. is not responsible for product failures and/or repair costs resulting from misuse (e.g. not allowing the muffler to cool which causes an after fire event), faulty installation, alteration, misapplication, faulty maintenance practices (e.g. cleaning or servicing of spark arrestors), neglect, or accident; nor is Nelson Global Products, Inc. responsible for downtime, loss of income, living expenses, or other incidental or consequential damages. Unless otherwise agreed to in writing, this Warranty is the sole warranty made by Nelson Global Products, Inc. NELSON GLOBAL PRODUCTS, INC. MAKES NO OTHER WARRANTIES, EXPRESS OR IMPLIED, OF MERCHANTABILITY OR FITNESS FOR A PARTICULAR PURPOSE.

Exhaust Products Warranty Coverage Periods for Nelson Global Products, Inc.

Duration of Warranty period (whichever occurs first)		
Application / Product	Years	Distance (miles/km)
On-Highway		
Heavy Duty (Class 8)	1	100,000 / 161,000
Medium Duty (Class thru 7)	1	100,000 / 161,000
Transit Bus	1	50,000 / 80,500
Coach bus	1	100,000 / 161,000
Off-highway	1	N/A
Product / Parts		
Mufflers – O.E. / Std. Line	1	N/A
Tubes – Formed / Assemblies	1	N/A
Accessories - clamps, rain caps, heat-shields, adaptors, etc.	1	N/A
Pre-treatment exhaust assemblies *	1	N/A
Post-Treatment exhaust assemblies *	1	N/A
Chrome or aesthetic coated components	1	N/A
Flex pipe (interlocking/bellows design)	None	Sold "as is"
Retrofit kits	1	100,000 / 161,000
Catalytic Exhaust Mufflers – Gas/Diesel	1	100,000 / 161,000

* Note: Purchaser is responsible for all application, endurance and verification testing prior to production release.

Table of Contents

- Section 1: Muffler Guide 1-1**
 - Introduction..... 1-3
 - Top Quality Construction 1-3
 - Objectives of This Guide..... 1-3
 - Troubleshooting and Repairing the Exhaust System 1-3
 - How to Reduce Exhaust-Related Noise Levels..... 1-4
 - Applications 1-4
 - Welding Aluminized Steel 1-6
 - Flexible Metal Tubing (Flex) Measurement and Cutting..... 1-6
 - Measuring Length of Flexible Metal Tubing 1-7
 - Joining Flex to Straight Pipe..... 1-8
 - Cleaning Chrome 1-8
 - TorcTite™ – The “Seal of Strength™” 1-9

- Section 2: Exhaust Accessories 2-1**
 - Guillotine U-Bolt Clamps 2-4
 - Flat Band U-Bolt Clamps..... 2-4
 - Round U-Bolt Clamps 2-4
 - Welded Saddle U-Bolt Clamps 2-4
 - AccuSeal™ Clamps 2-5
 - Flat Band Clamps..... 2-5
 - Wide Band EasySeal™ Clamps 2-6
 - Wide Band ValuSeal™ Clamp 2-6
 - TorcTite™ Lap Clamps..... 2-7
 - TorcTite™ Butt Clamps 2-7
 - V-Band Clamps 2-8
 - Flared Connectors – Type 1 2-10
 - Flared Connector – Type 2 2-10
 - Flared Connectors – Type 3..... 2-11
 - Flared Connectors – Type 4..... 2-11
 - Straight Connectors 2-12
 - Reducing Connectors 2-12
 - Tilt Cab Connectors 2-13
 - Threaded Adapter 2-13
 - Flexible Connectors..... 2-14
 - Tube Connectors..... 2-14
 - Stainless Steel Corrugated Connectors 2-14
 - Weld Connectors 2-15
 - Clamp Connectors 2-15
 - Flared Adapters..... 2-16
 - Full Marmon Adapters 2-16
 - V-Band Clamps and Gaskets 2-16

Table of Contents

Expanders with Clamp Connections.....	2-17
Stainless Steel PolyLock™	2-19
Stainless Steel Flex.....	2-19
Aluminized Flex	2-19
Galvanized Flex	2-19
15° Elbows.....	2-20
30° Elbows.....	2-20
45° Elbows.....	2-20
60° Elbows.....	2-21
70° Elbows.....	2-21
90° Elbows.....	2-22
45° Stainless Steel Elbows	2-26
90° Stainless Steel Elbows	2-26
Replacement Elbow for Freightliner® Series	2-27
Tube Expander	2-28
Splitter Tee Adapter Tube	2-28
Conventional Wye Tube.....	2-28
Straight Tubing	2-29
High Performance Flex Tubes.....	2-29
Special Bluebird™ Tubes	2-30
Special Ford™ Tubes	2-30
Special Freightliner® Tubes	2-31
Special GMC®/Chevrolet® Tubes	2-31
Special International®/Navistar® Tubes.....	2-32
Special Kenworth™ Tubes	2-35
Special Mack® Tubes.....	2-36
Special Peterbilt™ Tubes.....	2-36
Special Western Star® Tube.....	2-36
Curved Stack Pipes and Tail Pipes	2-40
90° Curved Stack Pipes	2-41
Dump Truck Stacks.....	2-41
Custom Length Stacks.....	2-41
6" by 5" (152 mm by 127 mm) "Monster" Stacks	2-42
Exhaust Diffusers	2-44
Slotted Stack Exhaust Diffusers.....	2-44
Slotted Stack Exhaust Diffuser U-Bolt Clamp	2-44
Stack Support Brackets	2-45
Universal Mounting Bracket.....	2-45
360° Guard Bracket Kit	2-45



Table of Contents

- Universal Swivel Hangers 2-46
- Universal Pipe Hangers 2-46
- Universal Muffler Hangers..... 2-46
- Clamp Kits 2-47
- Universal Grab Hanger 2-47
- Rain Caps 2-47
- Silent Rain Caps..... 2-47
- Exhaust Elbow/Pipe Shield 2-48
- Chrome Light Deflectors..... 2-48
- Mounting Bands..... 2-48

- Section 3: Standard Line Mufflers 3-1**
 - Type 1 3-3
 - End In/Opposite End Out
 - Both On Center 3-3
 - Type 2..... 3-8
 - End In/Opposite End Out
 - Both Offset..... 3-8
 - Type 2A 3-12
 - Dual End In/ Opposite End Out 3-12
 - Type 3..... 3-13
 - End In/End Out – Same End..... 3-13
 - Type 4..... 3-14
 - End In/Opposite End Out – Outlet Offset 3-14
 - Type 5..... 3-15
 - Side In/End Out..... 3-15
 - Type 7 3-18
 - End In/Side Out..... 3-18
 - Type 8..... 3-21
 - Side In / Side Out 3-21
 - Installation Notes 3-22
 - Engine Data 3-22

Table of Contents

Section 4: Off-Highway Industrial Mufflers	4-1
Type 1	4-3
End In/Opposite End Out Both On Center	4-3
Type 2	4-4
End In/Opposite End Out Both Offset	4-4
Type 3	4-5
End In/End Out – Same End	4-5
Type 5	4-6
Side In/End Out	4-6
Type 7	4-7
End In/Side Out	4-7
Type 8	4-8
Side In/Side Out	4-8
Single Inlet Round Muffler Accessories	4-9
Outlet Options	4-9
Clamps	4-10
Heat Shields and Brackets	4-10
Add-On Glass Packed Resonators	4-11
Section 5: Special Mufflers	5-1
Spark Arresters	5-3
Pak Stacks	5-3
Resonators	5-4
Splitter Tee Resonator	5-4
Wye Connector Resonator	5-4
Stainless Steel Mufflers	5-4
Section 6: Exhaust Cross Reference	6-1
Manufacturer's Abbreviations	6-21





Section 1: Muffler Guide



Table of Contents

Section 1:	
Muffler Guide	1-1
Introduction.....	1-3
Top Quality Construction.....	1-3
Objectives of This Guide	1-3
Troubleshooting and Repairing the Exhaust System	1-3
How to Reduce Exhaust-Related Noise Levels.....	1-4
Applications	1-4
Welding Aluminized Steel	1-6
Flexible Metal Tubing (Flex) Measurement and Cutting.....	1-6
Measuring Length of Flexible Metal Tubing.....	1-7
Joining Flex to Straight Pipe	1-8
Cleaning Chrome	1-8
TorcTite™ – The “Seal of Strength™”	1-9



Introduction

Nelson Global Products designs, manufactures and markets high performance OEM and aftermarket products for the global commercial vehicle, on-highway and off-highway markets. Our engineering is the best in the industry and employs the latest design and manufacturing techniques. We are the largest OEM supplier of exhaust systems and a leader in engine exhaust noise technology. Customers can count on our exhaust system products for OE quality.

Top Quality Construction

Our mufflers are constructed of heavy gauge aluminized and stainless steel to:

- Resist hot, corrosive exhaust gases
- Deter rust
- Extend service life

Note: *Aluminized steel tubes are not recommended for 2007 emission compliant engines. As the industry leader, we have the ability to manufacture stainless steel tubes and other accessories to meet the stringent 2007 emission regulations. Please call (608) 719-1800 to speak to an OEM account manager for details.*

Objectives of This Guide

- Provide a basic understanding of the exhaust system to assist in identifying replacement part needs
- Provide an understanding of how exhaust components effect overall vehicle performance and fuel efficiency

Troubleshooting and Repairing the Exhaust System

The following guidelines are intended to help locate and identify problem areas in the vehicle's exhaust system:

- **Entire Exhaust System** – Check the system for leaks from the manifold pipe connector before and after repairs are made.
- **Mufflers** – Inspect the area around clamps for breakage, cracks and rust-through. A leaking muffler represents a potential safety hazard as it may allow exhaust gases to be discharged near, or under, the operator's compartment creating the potential for carbon monoxide to enter the compartment. Carbon monoxide is a colorless, odorless, but toxic gas. On vertical systems, check to ensure that the heat guard around the muffler is secure and in place. If there is no heat shield you may want to consider adding one.
- **Elbows, Stacks and Exhaust Pipes** – Dents or crushed portions of any tubing create exhaust flow restriction and increase back pressure significantly. Even relatively small dents will cause decreased fuel economy and increased turbo wear. Always check for dented pipes and do not over-torque clamps as this can lead to pipe crimping.
- **Rain Caps** – Our mufflers are designed to prevent water and snow from passing beyond the muffler to the engine. Water entering the muffler will create a slurry of soot and be blown on the trailer later causing significant cleanup expense. A curved exhaust stack is an acceptable alternative to a rain cap but may not be 100 percent effective in all conditions. Make sure an existing rain cap is in place and still in good condition.

Muffler Guide

- **Clamps** – New clamps should be installed anytime a muffler or pipe is replaced. Check the general condition of all clamps and joints in the exhaust system. Reuse of any clamps is not recommended.
- **Flexible Tubing** – Do not patch flexible hose (flex), always replace the entire section. Stainless steel flex is recommended as the best value due to its superior high temperature strength and oxidation resistance as compared to other materials. Examine any flex pipe to make sure it's in good condition and will perform properly.
- **Mounting** - The exhaust system must be secured to eliminate vibration. The muffler brackets should fit securely to the muffler and to the mast or truck frame.

How to Reduce Exhaust-Related Noise Levels

1. Worn or leaking flexible tubing is a common noise source. Replace the part, if necessary. The service life of flexible tubing can be improved if it is installed in a relaxed position. Bending, stretching and compressing all reduce life because they limit the tubing's ability to "flex."
2. The entire exhaust system should be well-supported. This will reduce the noise generated by the exhaust pipes and the muffler shell. Care must be taken to isolate engine vibration from the exhaust system and to provide for expansion when the system is hot.
3. The addition of a universal resonator, silenced "wye" or splitter muffler in the system will generally reduce the exhaust noise level from 3 to 6 dBA. Packed stacks will reduce the noise level 3 to 4 dBA. Both items have a minimal effect on engine backpressure.
4. Change from a single to a dual system. For maximum benefit, special "dual only" mufflers are usually recommended. Lower system backpressure is generally an additional benefit of dual systems.
5. On horizontal systems, the tail spouts should be pointed towards the center of the roadway. This reduces the noise reflected off of the road surface and perceived by curbside observers.
6. On vertical systems, straight stacks will yield lower sound levels than will curved stacks. Straight stacks direct the noise upward, where curved stacks direct noise towards the observer.

Applications

There are two basic exhaust system configurations - vertical and horizontal. Comparison of the illustrations of these two systems shows there is little difference in the components used. In most vertical installations the muffler is bolted to a mast structure in order to reduce the amount of muffler noise transferred into the cab or tractor. Vertical stacks help to get any objectionable odor up in the air - away from ground level. Vertical installations are also perceived as being quieter because sound is directed upward by the stacks. The need for improved aerodynamics has led to the increased usage of horizontal exhaust systems. The schematics show the overall layout of the components used in both vertical and horizontal installations. It is possible to find a vertical and a horizontal application in any truck class. School bus applications must meet some very stringent local regulations for school bus exhaust systems that may include a horizontal system, a rear discharge, and a totally leak free system.

Muffler Guide

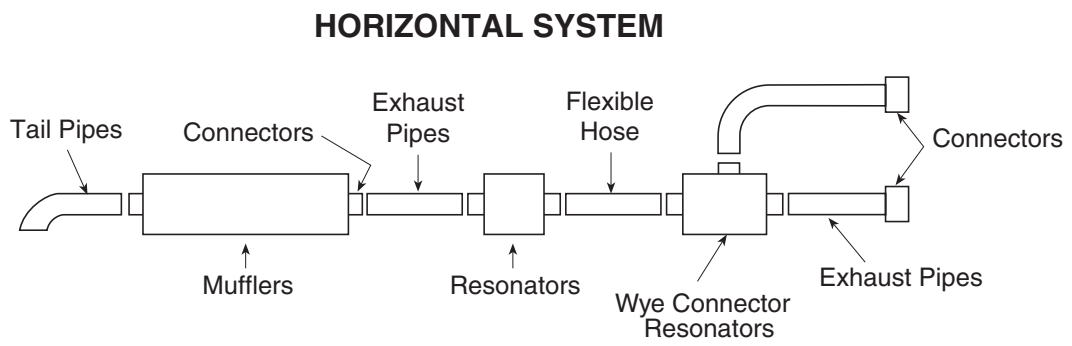
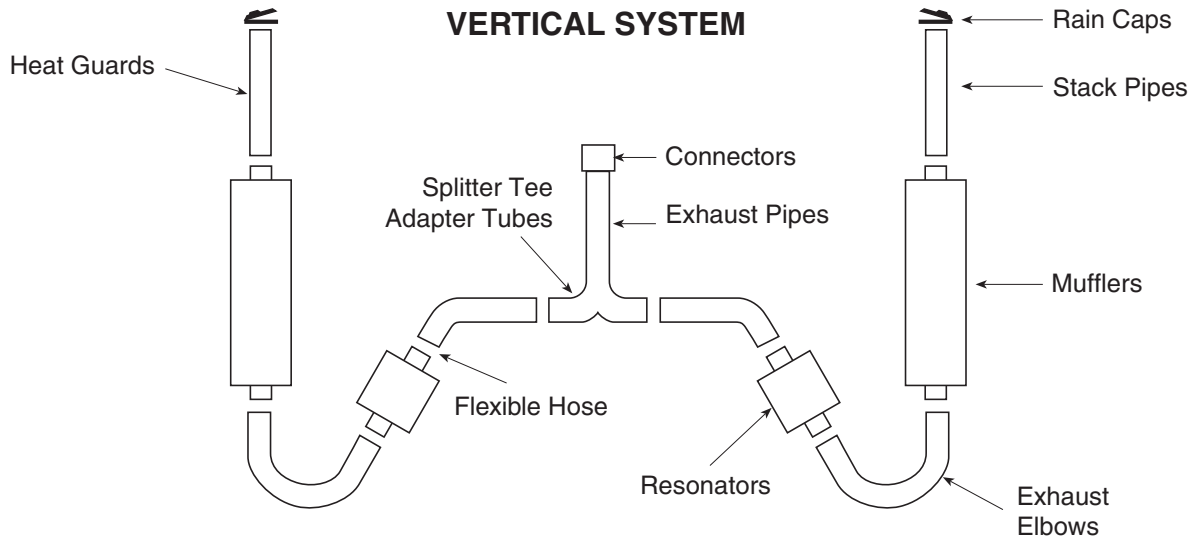

Muffler Guide

Welding Aluminized Steel

Aluminized steel can be welded using appropriate techniques which are described below.

Oxyacetylene Welding Filler Metal

Use a mild steel filler metal, 3/32" diameter, free of rust (American Welding Society classification A5.2). Do **not** use copper coated filler material.

Welding Equipment: Use a number 3 or 4 tip. Observe instructions of the equipment manufacturer when adjusting the operating pressures at the gas regulators.

Procedure: Clean the parts to be welded thoroughly. Incline the torch at a 45° angle from the direction of travel. Use the forehand welding technique. Keep the torch flame on the tip of the filler rod, not in the center of the puddle.

Shielded Metal-Arc (Stick Electrode)

Any one of the following rods are recommended:

- E-6011
- Low Hydrogen: E-7108.
- Stainless: 309 or 310

Gas Metal-Arc (MIG)

- Wire: ER70S-3 or ER70S-6
- Shield gas: Carbon Dioxide or 75% Argon/25% CO₂

Flexible Metal Tubing (Flex) Measurement and Cutting

Strip-wound flexible metal hose is a typically round conduit, three to six inches inner diameter, and is flexible in nature due to the design of the strip. It is commonly used to absorb relative motion and vibration, typically between a vehicle's engine and frame or between the frame and cab. Often strip-wound flexible metal hose is used as a means to account for dimensional differences and tolerance stack-up in the exhaust system. Using strip-wound flexible metal hose to account for misalignments in the exhaust piping can compromise the flexibility to the extent that early failures occur. It is necessary that the hose is installed so that its maximum flexibility is preserved. This document provides detailed information to install flex hose properly so as to minimize failures.

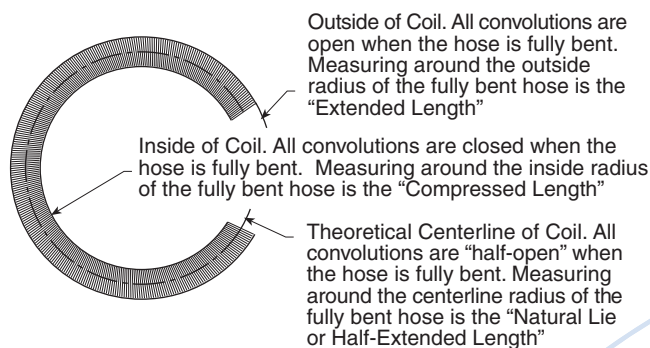

Measurement and cutting of flex tubing must be performed using the correct procedures. The following definitions are used to describe the various states that flex can be measured in:

Fully Extended: The tubing is in a fully expanded state and the convolutions are completely open. Approximately. 20% less metal is required than fully compressed.

Fully Compressed: The tubing in a fully compressed state and the convolutions are completely closed. Approximately. 20% more metal is required than fully extended.

Natural Lie: The average of fully compressed and fully extended lengths. Approximately 10% more metal is required than fully extended and 10% less metal is required than fully compressed. This is also referred to as the partially compressed state.

Nelson Global Products's **bulk flex tubing** is sold in 10' and 25' rolls measured in the **natural lie state**.

Nelson Global Products's **cut to length flex** is measured in the **fully extended state**.

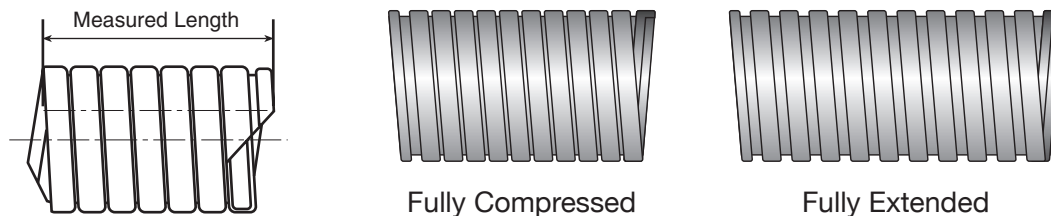

Nelson Global Products provides bulk flex in over length rolls to assure that the correct amount of natural lie tubing is provided to the customer. In many cases, these rolls of bulk flex tubing are subsequently cut to length for the end user. Inconsistent measurement and cutting procedures can result in apparent shortages of bulk tubing. It is important to insure that the customer is following the procedures described in the next section.

Measuring Length of Flexible Metal Tubing

Shipping will cause the tubing to compress beyond the natural lie state. Before cutting flex tubing, one end of the tube must be anchored and the other end pulled to its fully extend state and quickly released so that it snaps back into its natural lie condition.

Whenever flex tubing is measured or cut, it must be properly oriented. The piece being cut from the tube must come off of the **open end** of the bulk length of tube. The open end is the end at which the wraps appear to be on top of each other as they move away from the end of the tube. When measuring or cutting flex tubing, keep the **open side** of the tube to your right. The figure to the right shows how to measure length along with the proper orientation – open end on the right. Note how wraps are on top of one another when looking right to left and underneath one another when looking left to right.

Muffler Guide

To measure in the compressed state:

Measurement of flex should be done by laying out the tube on a level surface and curving the entire tube or section into a tight radius such that the inner side of the curved tube has its convolutions touching as shown in the figure to the right. When the inner radius of the flex pipe is fully compressed, the outer radius will be fully extended and the center line of the tube will be at its natural lie length as depicted in the figure.

To measure in the extended state:

1. Orient the tube properly. Insure that the open end is on your right. This will be the end to start measuring from.
2. Coil the tube in a tight radius as shown above.
3. Measure along the outside of the radius where the convolutions are all open.
4. Mark point on outer radius where cut is to be made. Cut using one of the methods described later in this section.

If selling in the natural lie state, the length should be measured off the bulk flex roll after restoring it to its pre-shipping state. Cutting methods are same as below.

Cutting

Non PolyLock™ flex hose must be tack welded prior to cutting. Ensure tubing is straight and cut at fully extended mark using one of the approved methods below:

- **For Chop Saw Cuts:** Use 1/16" wide blade for best results
- **For Band Saw Cuts:** Use a no-set blade with 24-32 teeth / inch
- **For Hack Saw Cuts:** Use a no-set blade with 24-32 teeth / inch

Note: *Cutting and measuring flex tubing in any other way can cause an apparent shortage.*

Joining Flex to Straight Pipe

It is important to use the proper type of clamp to hold and seal the tube-to-flex joint. It is required to use a TorcTite™ clamp, or equivalent, at both ends of the flex hose. This style of clamp is preformed to fit properly on the outer diameters of the flex hose and mating tubes. This clamp fits generally one half on the flex hose and one half on the mating tube.



Cleaning Chrome



The following are general tips and procedures to use when cleaning chrome exhaust components.

1. Always wash your chrome with a mild, nonabrasive, alkaline detergent (like most truck and automotive detergents) and a soft, nonabrasive cloth.
2. Rinse thoroughly.
3. Quickly dry your chrome with a soft, nonabrasive cloth before water spots have a chance to form.
4. When polishing chrome, a good quality chrome polish provides the best results. Read and follow all instructions for the polish you use. Use a nonabrasive, non-colored (not dyed) cloth to apply and remove polish.
5. It is not recommended that you use wax on chrome exhaust products. The sustained high temperatures associated with exhaust can adversely affect a waxed chrome finish.

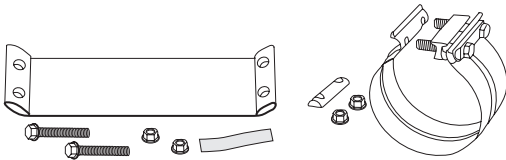
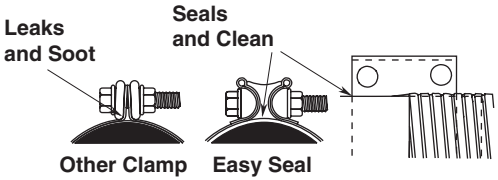
TorcTite™ – The “Seal of Strength™”

Feature		Benefit
	<p>TorcTite™ is the only clamp with fastener hardware pre-attached to a bright-finish band.</p>	<p>Installation is fast, easy and accurate. Simply wrap the clamp band with its pre-attached hardware around pipes; insert the extra-long bolts through the opposite clamp end, force bars and nuts, and torque. No dropping or fumbling with loose or excessive parts. The pre-formed band makes an accurate I.D. - O.D. installation even easier, and causes no damaging distortion to pipe or flex hose. This high-tensile steel with TorcTite's exclusive reaction block has greater stretching capability than other band clamps.</p>
	<p>TorcTite's™ exclusive, pliable aluminum reaction block conforms tightly to exhaust components providing a superior seal.</p>	<p>During installation, the block conforms to the I.D. - O.D. step between pipes, creating a unique seal. The block actually digs into flex hose spirals. Other clamps leave leaky gaps between the clamp band ends and pipes; TorcTite's patented reaction block, specially-formed band and fasteners all work together to seal these leaks. And it seals without loose gaskets or sealant additives.</p>
	<p>TorcTite's™ reaction block will not pinch flex hose and pipes, which means TorcTite will not cause leak paths or damage expensive exhaust components.</p>	<p>Other inferior clamps pinch exhaust pipes and flex hose during installation, creating exhaust leak paths. TorcTite's reaction block completes a full 360-degree compressive seal without damage – eliminating pinching, distortion and damage to pipes. Expensive flex hose, pipes and muffler inlets remain unharmed.</p>
	<p>TorcTite's™ reaction block and independent force bars prevent bolt bending and clamp binding which makes installation time fast and easy.</p>	<p>A balanced transfer of forces among TorcTite's specially formed band, reaction block and independent-force-bars eliminates bending forces on bolts, which keeps installation torque very low. Clamp binding is eliminated, too. The unique balanced design results in a strong, tightly-sealed exhaust joint that assembles quickly and reliably.</p>



Section 2: Exhaust Accessories



Table of Contents

Section 2: Exhaust Accessories.....2-1

Clamps	2-4
Guillotine U-Bolt Clamps.....	2-4
Flat Band U-Bolt Clamps	2-4
Round U-Bolt Clamps.....	2-4
Welded Saddle U-Bolt Clamps	2-4
AccuSeal™ Clamps.....	2-5
Flat Band Clamps	2-5
Wide Band EasySeal™ Clamps	2-6
Wide Band ValuSeal™ Clamp	2-6
TorcTite™ Lap Clamps	2-7
TorcTite™ Butt Clamps.....	2-7
V-Band Clamps	2-8
Connectors	2-10
Flared Connectors – Type 1	2-10
Flared Connector – Type 2.....	2-10
Flared Connectors – Type 3	2-11
Flared Connectors – Type 4	2-11
Straight Connectors.....	2-12
Reducing Connectors.....	2-12
Tilt Cab Connectors.....	2-13
Threaded Adapter.....	2-13
Flexible Connectors	2-14
Tube Connectors	2-14
Stainless Steel Corrugated Connectors	2-14
Weld Connectors.....	2-15
Clamp Connectors.....	2-15
Adapters	2-16
Flared Adapters	2-16
Full Marmon Adapters.....	2-16
V-Band Clamps and Gaskets.....	2-16
Expanders with Clamp Connections	2-17
Flexible Hose Cut to Length	2-18
10' and 25' Flexible Hose.....	2-19
Stainless Steel PolyLock™	2-19
Stainless Steel Flex	2-19
Aluminized Flex.....	2-19
Galvanized Flex.....	2-19

Elbows.....	2-20	
15° Elbows	2-20	
30° Elbows	2-20	
45° Elbows	2-20	
60° Elbows	2-21	
70° Elbows	2-21	
90° Elbows	2-22	
45° Stainless Steel Elbows.....	2-26	
90° Stainless Steel Elbows.....	2-26	
Replacement Elbow for Freightliner®	Series	2-27
Tubes.....	2-28	
Tube Expander	2-28	
Splitter Tee Adapter Tube.....	2-28	
Conventional Wye Tube	2-28	
Straight Tubing	2-29	
High Performance Flex Tubes	2-29	
Special Tubes.....	2-30	
Special Bluebird™ Tubes.....	2-30	
Special Ford™ Tubes.....	2-30	
Special Freightliner® Tubes.....	2-31	
Special GMC®/Chevrolet® Tubes... 2-31		
Special International®/Navistar® Tubes .	2-32	
Special Kenworth™ Tubes.....	2-35	
Special Mack® Tubes	2-36	
Special Peterbilt™ Tubes	2-36	
Special Western Star® Tube	2-36	
Stack Pipes.....	2-37	
Curved Stack Pipes and Tail Pipes	2-40	
90° Curved Stack Pipes.....	2-41	
Dump Truck Stacks	2-41	
Custom Length Stacks	2-41	
6" by 5" (152 mm by 127 mm) "Mon-	ster" Stacks.....	2-42
Heat Guards	2-43	
Exhaust Diffusers	2-44	
Slotted Stack Exhaust Diffusers	2-44	
Slotted Stack Exhaust Diffuser U-Bolt	Clamp.....	2-44



Table of Contents



- Brackets 2-45
 - Stack Support Brackets..... 2-45
 - Universal Mounting Bracket 2-45
 - 360° Guard Bracket Kit..... 2-45
- Hangers 2-46
 - Universal Swivel Hangers 2-46
 - Universal Pipe Hangers..... 2-46
 - Universal Muffler Hangers 2-46
- Miscellaneous Accessories..... 2-47
 - Clamp Kits..... 2-47
 - Universal Grab Hanger..... 2-47
 - Rain Caps..... 2-47
 - Silent Rain Caps 2-47
 - Exhaust Elbow/Pipe Shield 2-48
 - Chrome Light Deflectors 2-48
 - Mounting Bands 2-48

Exhaust Accessories

Clamps

Guillotine U-Bolt Clamps

- Available in both Zinc and Chrome plated
- Forms 360° seal



Size in (mm)	Zinc Plated Part Number	Chrome Plated Part Number
2.00 (50.80)	89541K	—
2.25 (57.15)	89542K	—
2.50 (63.50)	89543K	—
2.75 (69.85)	89544K	—
3.00 (76.20)	89545K	—
3.25 (82.55)	89546K	—
3.50 (88.90)	89547K	—
4.00 (101.60)	89548K	89548C
4.50 (114.30)	90092A	—
5.00 (127.00)	89549K	89549C
6.00 (152.40)	89550K	89550C

Round U-Bolt Clamps

- Available in mild steel finish
- Standard 3/8" U-Bolt



Size in (mm)	Part Number
1.50 (38.10)	90927K
1.75 (44.45)	90928K
1.88 (47.75)	90914K
2.00 (50.80)	90929K
2.25 (57.15)	90915K
2.50 (63.50)	90916K
2.75 (69.85)	900040K
3.00 (76.20)	900041K
3.50 (88.90)	900042K
4.00 (101.60)	900043K
5.00 (127.00)	900044K

Flat Band U-Bolt Clamps

- Available in both Zinc and Chrome plated
- 3/8" (9.5 mm) U-Bolt
- Selected sizes of zinc-plated bulk packs are available in single units or bulk packs. Add (B) to part number.



Size in (mm)	Zinc Plated Part Number	Chrome Plated Part Number
3.00 (76.20)	89556K	89566K
3.50 (88.90)	89557K	—
4.00 (101.60)	89558K*	89568K
5.00 (127.00)	89559K*	89569K
6.00 (152.40)	89560K	89570K

* Available in bulk (50/carton) as "B" Version

Welded Saddle U-Bolt Clamps

- 3/8" (9.5 mm) U-Bolt
- Extra long U-Bolt for use with brackets

Size in (mm)	Part Number
3.00 (76.20)	90866A
4.00 (101.60)	90867A
5.00 (127.00)	90868A

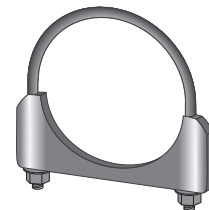

Specifications subject to change without notice. See page 1-8 for cleaning chrome.

All parts listed are subject to lead time.

Exhaust Accessories

Clamps

AccuSeal™ Clamps

Size in (mm)	Aluminized Part Number	Stainless Part Number
2.00 (50.80)	90869A	–
2.25 (57.15)	90870A	–
2.75 (69.85)	90872A	900019A**
3.00 (76.20)	90873A	900003A*
3.50 (88.90)	90874A	900004A*
4.00 (101.60)	90875A	90885A*
4.50 (114.30)	90876A	–
5.00 (127.00)	90877A	90887A*
6.00 (152.40)	90878A	–

* Bright 430 Stainless Steel

** 409 Stainless Steel bands with metric hardware

- Clamp technology provides simple, effective way to replace U-bolt and guillotine clamps
- Creates over a ton of clamping force without crushing pipes, resulting in strong, serviceable joint
- Pre-assembled hardware
- Fast, easy and accurate installation
– slip clamp over slotted side of joint, insert mating pipe and torque to 40-60 ft-lbs (54-81 N·m)



Flat Band Clamps

Size in (mm)	Stainless Part Number
3.00 (76.20)	89525W
3.50 (88.90)	89526W
4.00 (101.60)	89527W
5.00 (127.00)	89528W

- Older style seal clamp



Exhaust Accessories

Clamps

- Available in either the pre-formed TorcTite™ or flat EasySeal™ or ValuSeal™ style, these clamps stop leaky gaps between both overlapping and butt joints.
- The unique reaction block design results in a strong, tightly sealed and reliable exhaust joint without the need for extra gaskets.
- All clamps come with longer bolts and preattached hardware.

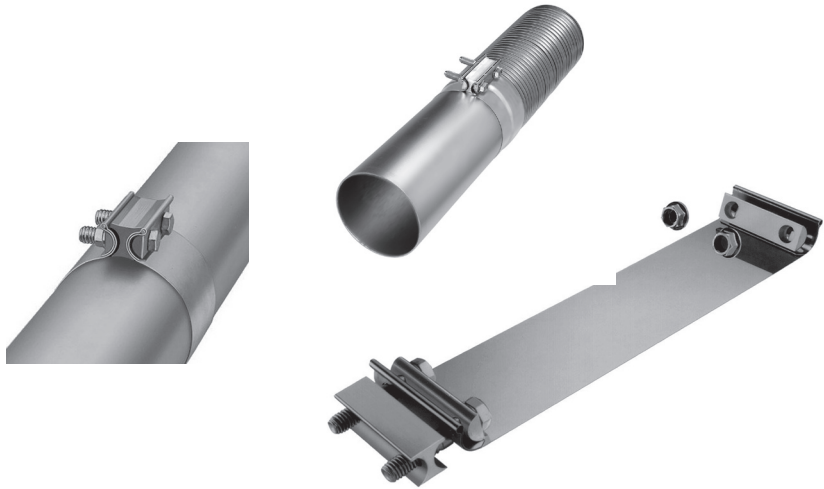

Wide Band EasySeal™ Clamps

Size in (mm)	Single Part Number	Bulk 40/Carton Part Number
2.00 (50.80)	89521K	—
2.25 (57.15)	89522K	—
2.50 (63.50)	89523K	—
2.75 (69.85)	89524K	—
3.00 (76.20)	89525K	89525B
3.50 (88.90)	89526K	89526B
4.00 (101.60)	89527K	89527B
4.50 (114.30)	90464K	—
5.00 (127.00)	89528K	89528B
6.00 (152.40)	89529K	—

- Flat, universal wide band clamp
- Bright 304 stainless steel band material – looks great with chrome
- Cardboard skin packaging for easy display

Wide Band ValuSeal™ Clamp

Size in (mm)	Part Number
5.00 (127.00)	900273A

- Flat, universal wide band clamp
- Plain 304 stainless steel band material (same performance and strength as EasySeal™)
- Individually boxed with pre-attached hardware

Specifications subject to change without notice. See page 1-8 for cleaning chrome.
All parts listed are subject to lead time.

Exhaust Accessories

Clamps

TorcTite™ Lap Clamps

Size in (mm)	Aluminized Steel Part Number		Stainless Steel Part Number		
	Single	Bulk 50/ Carton*	Single	Bulk 50/ Carton*	Polished Single**
2.00 (50.80)	90350A	—	—	—	—
2.25 (57.15)	—	—	90361A	—	—
2.50 (63.50)	90352A	90352B	—	—	—
2.75 (69.85)	90353A	—	90363A	—	—
3.00 (76.20)	90354A	—	90364A	90364B	—
3.50 (88.90)	90355A	—	90365A	90365B	—
4.00 (101.60)	—	90356B	—	90366B	90546K
4.50 (114.30)	90357A	—	90367A	—	—
5.00 (127.00)	90358A	90358B	90368A	90368B	90547K
6.00 (152.40)	90359A	90359B	90369A	—	—

- Aluminized or Stainless Steel
- 360° sealing for overlapping tubes



* Unassembled, nested in ten-packs with hardware, five ten-packs per carton

** Polished to match chrome elbow and stack finish

TorcTite™ Butt Clamps

Size in (mm)	Aluminized Steel Part Number		Stainless Steel Part Number	
	Single	Bulk 50/ Carton*	Single	Bulk 50/ Carton*
2.50 (63.50)	—	—	90382A	—
3.00 (76.20)	90374A	90374B	90384A	—
3.50 (88.90)	90375A	90375B	90385A	—
4.00 (101.60)	90376A	—	90386A	90386B
4.50 (114.30)	—	—	90387A	—
5.00 (127.00)	90378A	90378B	90388A	90388B
6.00 (152.40)	90379A	—	90389A	—

- Aluminized or Stainless Steel
- Positive clamping action for equal sized tubes without overlap



* Unassembled, nested in ten-packs with hardware, five ten-packs per carton

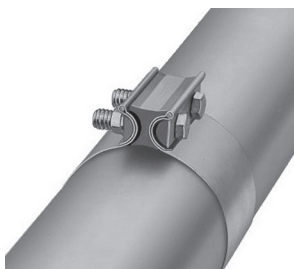

Exhaust Accessories

Clamps

V-Band Clamps

- V-Band Clamps are made of Type 321 stainless steel
- The function of the V-Band Clamp is to connect the manifold or turbocharger to the exhaust system
- These clamps are designed to accommodate the majority of engine applications and are available in a variety of sizes

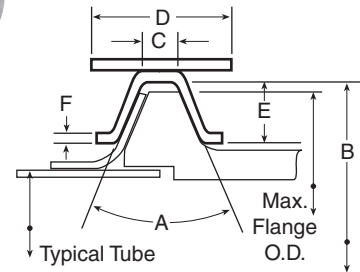

Tube O.D.*	Part Number	Application	Dimensions						
			A	B in (mm)	C in (mm)	D in (mm)	E in (mm)	F in (mm)	Max. Flange O.D. in (mm)
2.75 (69.85)	89571K	Cummins B	40°	3.22 (81.79)	0.262 (6.66)	0.85 (21.59)	0.14 (3.56)	0.050 (1.27)	3.13 (79.50)
3.00 (76.20)	89530K	Ford D9HT-5I210-DA	40°	3.87 (98.30)	0.425 (10.80)	0.88 (22.35)	0.31 (7.87)	0.075 (1.91)	3.75 (95.25)
3.00 (76.20)	89505K	DD 6V53-71	40°	3.82 (97.03)	0.207 (5.26)	0.88 (22.35)	0.28 (7.11)	0.080 (2.03)	3.70 (93.98)
3.00 (76.20)	89500K	Cummins V903, Ford 370 & 429, E5HZ-5A231-B	40°	3.88 (98.55)	0.400 (10.16)	0.88 (22.35)	0.28 (7.11)	0.050 (1.27)	3.76 (95.50)
3.13 (79.50)	89511K	OE Muffler	40°	3.96 (100.58)	0.207 (5.26)	0.88 (22.35)	0.28 (7.11)	0.080 (2.03)	3.84 (97.54)
3.50 (88.90)	89573K	Cummins C	40°	4.12 (104.69)	0.262 (6.66)	0.67 (17.02)	0.14 (3.56)	0.050 (1.27)	4.03 (102.36)
3.50 (88.90)	89531K	Cat 3208T, Ford 6.6, 7.8, E2HT5A212AA	40°	4.19 (106.43)	0.400 (10.16)	0.88 (22.35)	0.28 (7.11)	0.050 (1.27)	4.07 (103.38)
3.50 (88.90)	89512K	IH DT466 & Connector Ends	40°	4.31 (109.47)	0.207 (5.26)	0.88 (22.35)	0.28 (7.11)	0.080 (2.03)	4.19 (106.43)
3.50 (88.90)	89506K	DD8V71-671	40°	4.50 (114.30)	0.207 (5.26)	0.88 (22.35)	0.28 (7.11)	0.080 (2.03)	4.38 (111.25)
3.50 (88.90)	89501K	Cummins VT555	40°	4.25 (107.95)	0.400 (10.16)	0.88 (22.35)	0.28 (7.11)	0.050 (1.27)	4.16 (105.66)
4.00 (101.60)	89508K	DD 8.2N	40°	4.06 (103.12)	0.239 (6.07)	0.88 (22.35)	0.29 (7.37)	0.075 (1.91)	3.94 (100.08)
4.00 (101.60)	89520K	Cat 3126T, Cat 3176T, Cummins L10, Cummins M11	40°	4.75 (120.65)	0.400 (10.16)	0.88 (22.35)	0.28 (7.11)	0.050 (1.27)	4.63 (117.60)
4.00 (101.60)	89509K	DD 8.2T, GM 2295978	40°	4.75 (120.65)	0.158 (4.01)	0.88 (22.35)	0.31 (7.87)	0.075 (1.91)	4.63 (117.60)
4.00 (101.60)	89532K	Mack 11ME29	40°	4.94 (125.48)	0.181 (4.60)	0.75 (19.05)	0.28 (7.11)	0.062 (1.58)	4.82 (122.43)

Specifications subject to change without notice. See page 1-8 for cleaning chrome.
All parts listed are subject to lead time.

Exhaust Accessories

Clamps

V-Band Clamps

Tube O.D.*	Part Number	Application	Dimensions						Max. Flange O.D. in (mm)
			A	B in (mm)	C in (mm)	D in (mm)	E in (mm)	F in (mm)	
4.00 (101.60)	89502K	Switzer 4LDE, 4LE 4LH, 4LS	40°	4.50 (114.30)	0.262 (6.66)	0.75 (19.05)	0.14 (3.56)	0.050 (1.27)	4.41 (112.01)
4.00 (101.60)	89513K	Connector Ends	40°	4.81 (122.17)	0.207 (5.26)	0.88 (22.35)	0.28 (7.11)	0.080 (2.03)	4.69 (119.13)
4.00 (101.60)	89507K	DD 6-71	40°	4.91 (124.71)	0.293 (7.44)	1.13 (28.70)	0.30 (7.62)	0.090 (2.29)	4.79 (121.67)
4.00 (101.60)	89533K	Mack 48RU2341	40°	4.61 (117.09)	0.156 (3.96)	0.75 (19.05)	0.22 (5.59)	0.050 (1.27)	4.49 (114.05)
4.88 (123.95)	89510K	DD 8V71T, 6V92T, 8V92T	40°	5.25 (133.35)	0.262 (6.66)	0.75 (19.05)	0.14 (3.56)	0.050 (1.27)	5.16 (131.06)
5.00 (127.00)	89503K	Cummins T50 Turbo, M-11	40°	5.88 (149.35)	0.400 (10.16)	0.88 (22.35)	0.28 (7.11)	0.050 (1.27)	5.79 (147.07)
5.00 (127.00)	89514K	Connector Ends	40°	5.81 (147.57)	0.207 (5.26)	0.88 (22.35)	0.28 (7.11)	0.080 (2.03)	5.69 (144.53)
5.25 (133.35)	90531K	DD 8V71	40°	5.92 (150.37)	0.280 (7.11)	0.88 (22.35)	0.30 (7.62)	0.090 (2.29)	5.83 (148.08)

* Do not use this diameter to select a V-Band Clamp. It refers to a typical exhaust piping size which can vary by vehicle or engine model.

Dimensions

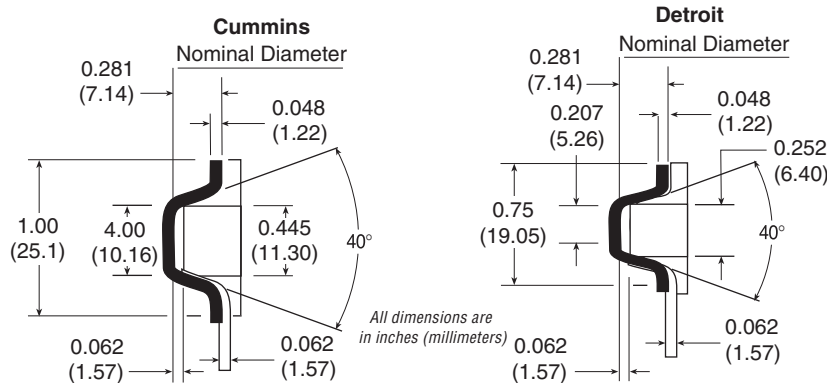

Exhaust Accessories

Connectors

- 16 gauge aluminized steel
- Designed for use with V-Band Clamps
- Standard 20° lip angle

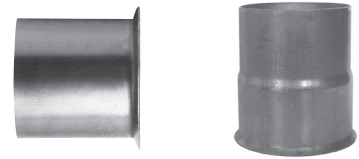

Flared Connectors – Type 1

Part Number	Dimensions					Clamp* Number	Application
	A (O.D.) in (mm)	B (I.D.) in (mm)	C (O.D.) in (mm)	D in (mm)	E		
89955K	3.00 (76.20)	3.00 (76.20)	3.63 (92.20)	4.00 (101.60)	22°	89505K	DD 6V-71
89956K	3.00 (76.20)	3.13 (79.50)	3.63 (92.20)	4.75 (120.65)	45°	89511K	
89958K	3.50 (88.90)	3.50 (88.90)	4.25 (107.95)	4.00 (101.60)	22°	89506K	DD 8V-71
89959K	4.00 (101.60)	4.00 (101.60)	4.50 (114.30)	4.75 (120.65)	45°	89513K	Cummins VT-555
89960K	4.00 (101.60)	4.00 (101.60)	4.75 (120.65)	4.00 (101.60)	22°	89507K	DD 6-71, 12V-71
89961K	5.00 (127.00)	5.00 (127.00)	5.50 (139.70)	4.75 (120.65)	45°	89514K	

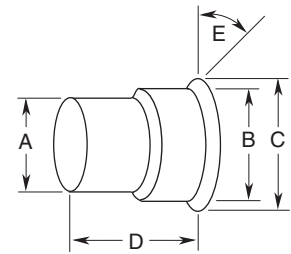

* See pages 2-8 and 2-9 for clamp details

Flared Connector – Type 2

Part Number	Dimensions					Clamp* Number	Application
	A (O.D.) in (mm)	B (O.D.) in (mm)	C (O.D.) in (mm)	D in (mm)	E		
89971K**	5.02 (127.51)	4.50 (114.30)	4.81 (122.17)	1.94 (49.28)	20°	89510K	DD 8V-71T, 16V-71T, 6V-92T, 8V-92T, 16V-92T

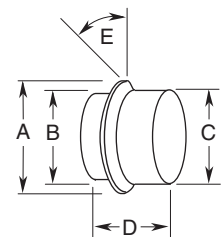

* See page 2-9 for clamp details

** Cast steel

Specifications subject to change without notice. See page 1-8 for cleaning chrome.
All parts listed are subject to lead time.

Exhaust Accessories

Connectors

Flared Connectors – Type 3

Part Number	Dimensions					Clamp* Number	Application
	A (O.D.) in (mm)	B (O.D.) in (mm)	C (O.D.) in (mm)	D in (mm)	E		
900134A	2.50 (63.50) ID	2.50 (63.50) ID	3.10 (78.74)	4.00 (101.60)	20°	89571K	Cummins B
90567A	–	–	3.50 (88.90)	3.50 (88.90)	45°	89505K	DD 53 Series
89962K	3.50 (88.90)	–	4.00 (101.60)	3.50 (88.90)	22°	89531K	Cat 3208-T
89963K	–	–	4.00 (101.60)	5.00 (127.00)	45°	89512K	Detroit Diesel
89964K	4.00 (101.60)	4.00 (101.60)	4.63 (117.60)	3.50 (88.90)	20°	89509K	DD 8.2 Liter T, Cat 3126T
89965K	–	4.00 (101.60)	4.50 (114.30)	5.00 (127.00)	45°	89513K	Cummins 250, L10
89966K	5.00 (127.00)	–	5.50 (139.70)	5.00 (127.00)	45°	89514K	Cummins
89967K	–	–	5.75 (146.05)	3.00 (76.20)	18°	89503K	T-50 Turbo Charger, Cummins M11
90569A	5.00 (127.00) ID	5.00 (127.00) ID	5.50 (139.70)	3.00 (76.20)	22°	–	

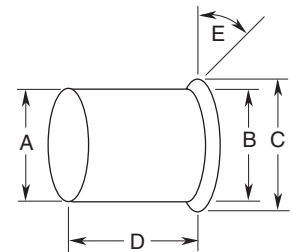

* See pages 2-8 and 2-9 for clamp details

Flared Connectors – Type 4

Part Number	Dimensions			
	A (I.D.) in (mm)	C (O.D.) in (mm)	D in (mm)	E
90572A	3.00 (76.20)	3.75 (95.25)	1.00 (25.40)	90°
90573A	3.50 (88.90)	4.25 (107.95)	1.00 (25.40)	90°
90575A	4.00 (101.60)	4.75 (120.65)	1.00 (25.40)	90°
90854A	5.00 (127.00)	5.93 (150.62)	0.75 (19.05)	20°

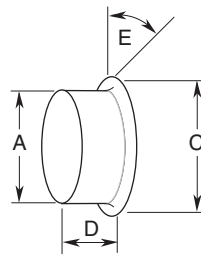

Exhaust Accessories

Connectors

Straight Connectors

- 16 gauge aluminized steel

Diameter in (mm)	Part Number			
	O.D. - O.D.	Beaded O.D. - O.D.	O.D. - I.D.	I.D. - I.D.
2.00 (50.80)	—	—	89249A	89261A
2.50 (63.50)	—	—	89250A	89263A
2.75 (69.85)	—	—	89251A	—
3.00 (76.20)	—	—	89164A	89160A
3.50 (88.90)	89246A	—	89165A	89161A
4.00 (101.60)	89247A	—	89166A	89162A
5.00 (127.00)	89248A	—	89167A	89163A
6.00 (152.40)	—	—	89252A	89266A

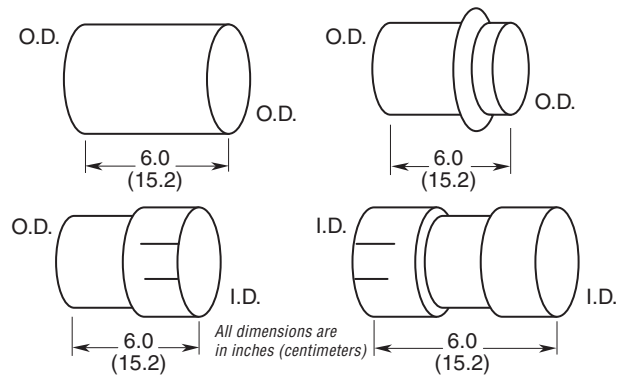

Reducing Connectors

- 16 gauge aluminized steel

Diameter in (mm)	Part Number			
	I.D. - I.D.	I.D. - O.D.	O.D. - I.D.	O.D. - O.D.
2.50 (63.50) x 2.25 (57.15)	—	—	89279A	—
3.00 (76.20) x 2.50 (63.50)	89271A	89168A	89182A	89253A
3.50 (88.90) x 3.00 (76.20)	89274A	89170A	89184A	89254A
4.00 (101.60) x 3.00 (76.20)	89275A	—	89185A	89881A
4.00 (101.60) x 3.50 (88.90)	89276A	89172A	89186A	89255A
4.50 (114.30) x 4.00 (101.60)	—	90560A	—	—
5.00 (127.00) x 4.00 (101.60)	89277A	89173A	89187A	89256A
6.00 (152.40) x 4.00 (101.60)	—	89282A	—	—
6.00 (152.40) x 5.00 (127.00)	89278A	89283A	—	89883A

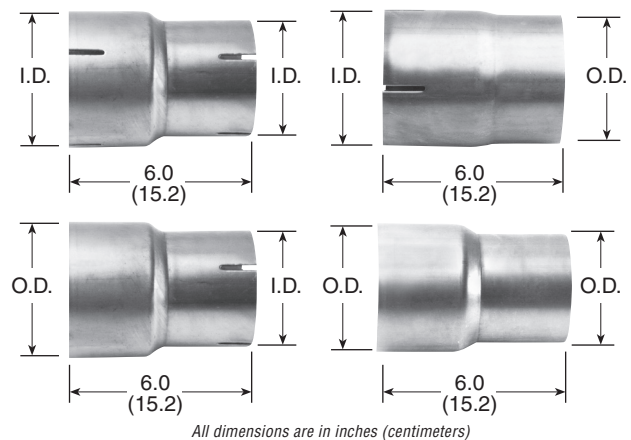

Specifications subject to change without notice. See page 1-8 for cleaning chrome.
All parts listed are subject to lead time.

Exhaust Accessories

Connectors



Top Connector
(shown unslotted)

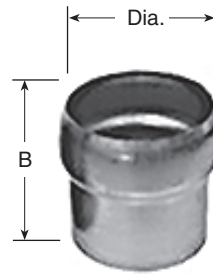

Bottom Connector
(shown unslotted)

Tilt Cab Connectors

- 16 gauge aluminized steel

Diameter in (mm)	A in (mm)	B in (mm)	Part Number	Description
Top Connectors				
4.00 (101.60) I.D.	5.70 (144.78)	–	90534A	Slotted
5.00 (127.00) O.D.	5.70 (144.78)	–	90533A	Slotted
Bottom Connectors				
4.00 (101.60) I.D.	–	4.60 (116.84)	90538A	Slotted
5.00 (127.00) I.D.	–	6.10 (154.94)	90539A	Slotted
5.00 (127.00) O.D.	–	6.20 (157.48)	90537A	Unslotted

Threaded Adapter

- 16 gauge aluminized steel

NPT Thread in (mm)	O.D. Diameter in (mm)	Length in (mm)	Part Number
4.00 (101.60)	4.00 (101.60)	6.00 (152.40)	90470K

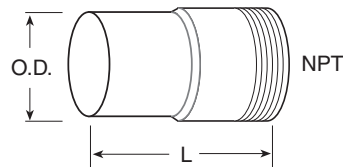

Exhaust Accessories

Connectors

Flexible Connectors

- Higher tolerance for vibration than standard flexible hose
- Heavy duty aluminized or stainless steel



Style C (Stainless Corrugated)

Style	Diameter in (mm)	Length in (mm)	Part Number
C	4.00 (101.60) I.D.	9.75 (247.65)	90453K

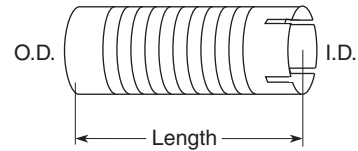

Diameter in (mm)	Length in (mm)	H/D Aluminized Connector O.D. - I.D. Part Number
4.00 (101.60)	18.00 (457.20)	89740K
5.00 (127.00)	18.00 (457.20)	89742K

Tube Connectors

- Provide leaktight, reusable joint where overlapping tube joints are not possible
- Can be installed in as little as 1.5" straight section of tubing
- Designed for welded installation
- Kit includes two flanges and the V-Band clamp

Size in (mm)	Clamp Part Number	Clamp & Flange Kit Part Number
3.50 (88.90)	89512K	90891K
4.00 (101.60)	89513K	90892K
5.00 (127.00)	89503K	90893K



Stainless Steel Corrugated Connectors

- Corrugated hose provides leak-proof flexible joints for critical applications
- Maximum bend is 10°
- Stainless steel corrugated with aluminized steel connector ends
- Higher tolerance for vibration than flexible hose
- Available in I.D.-I.D. or O.D.-I.D.
- 18" (457 mm) in length

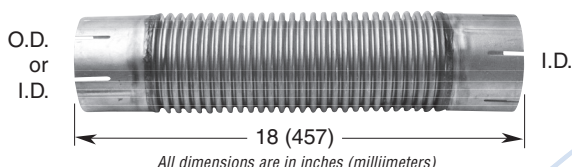

Size in (mm)	I.D. - I.D. Part Number	O.D. - I.D. Part Number
2.00 (50.80)	—	89791K
2.50 (63.50)	—	89792K
3.00 (76.20)	89786K	89794K
3.50 (88.90)	89787K	—
4.00 (101.60)	89788K	89796K
5.00 (127.00)	89789K	89797K
6.00 (152.40)	89790K	89798K

Specifications subject to change without notice. See page 1-8 for cleaning chrome.
All parts listed are subject to lead time.

Exhaust Accessories

Connectors

Weld Connectors

- 3.5" (88.90 mm) to 5.0" (127.00 mm) O.D. stainless steel
- I.D. sized for welding to elbows or straight tubes

Size in (mm)	Description	Part Number
3.50 (88.90)	Weld Connector – ID-ID Fit	900515A
4.00 (101.60)	Weld Connector – ID-ID Fit	900516A
5.00 (127.00)	Weld Connector – ID-ID Fit	900517A

New!



Clamp Connectors

- 3.5" (88.90 mm) to 5.0" (127.00 mm) O.D. stainless steel
- I.D.-I.D. sized for post attachment

Size in (mm)	Description	Part Number
3.50 (88.90)	Straight Connector ID-ID Clamp Fit	900563A
4.00 (101.60)	Straight Connector ID-ID Clamp Fit	900564A
5.00 (127.00)	Straight Connector ID-ID Clamp Fit	900565A

New!

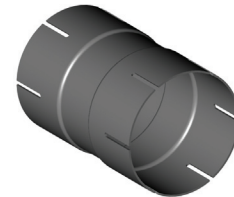

Note: Purchaser is responsible for all application, endurance and verification testing prior to production release.

Exhaust Accessories

Adapters

Flared Adapters

- 3.5" (88.90 mm) to 5.0" (127.00 mm) O.D. stainless steel
- I.D. sized for welding to elbows or straight tubes

New!

Size in (mm)	Description	Part Number
3.50 (88.90)	Flared Adapter (Marmon) – ID Weld Fit	900503A
4.00 (101.60)	Flared Adapter (Marmon) – ID Weld Fit	900504A
5.00 (127.00)	Flared Adapter (Marmon) – ID Weld Fit	900505A



Full Marmon Adapters

- 3.5" (88.90 mm) to 5.0" (127.00 mm) O.D. stainless steel
- I.D. sized for welding to elbows or straight tubes

New!

Size in (mm)	Description	Part Number
3.50 (88.90)	Flared Adapter (Marmon) – ID Weld Fit	900509A
4.00 (101.60)	Flared Adapter (Marmon) – ID Weld Fit	900510A
5.00 (127.00)	Flared Adapter (Marmon) – ID Weld Fit	900511A

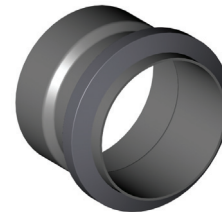

V-Band Clamps and Gaskets

- 3.5" (88.90 mm) to 5.0" (127.00 mm) O.D.

New!

Size in (mm)	Description	Part Number
3.50 (88.90)	V-Band Clamp (Marmon)	89501K
4.00 (101.60)	V-Band Clamp (Marmon)	A029T534
5.00 (127.00)	V-Band Clamp (Marmon)	A029T535
3.50 (88.90)	Gasket	Q312541
4.00 (101.60)	Gasket	Q312526
5.00 (127.00)	Gasket	Q312516



Note: Purchaser is responsible for all application, endurance and verification testing prior to production release.

Specifications subject to change without notice. See page 1-8 for cleaning chrome.
All parts listed are subject to lead time.

Exhaust Accessories

Adapters

Expanders with Clamp Connections

- 3.5" (88.90 mm) to 4.0" (101.60 mm) stainless steel
- 4.0" (101.60 mm) to 5.0" (127.00 mm) stainless steel
- Flare-flare and flare-Marmon adapters for V-band adapters
- ID Slotted for post aftertreatment

New!



Size in (mm)	Description	Part Number
3.50 (88.90) to 4.00 (101.60)	Expander – ID-ID Clamp Fit	900542A
4.00 (101.60) to 5.00 (127.00)	Expander – ID-ID Clamp Fit	900543A
3.50 (88.90) to 4.00 (101.60)	Expander – Flare-Marmon Clamp Fit	900544A
4.00 (101.60) to 5.00 (127.00)	Expander – Flare-Marmon Clamp Fit	900545A
3.50 (88.90) to 4.00 (101.60)	Expander – Flare-Flare Clamp Fit	900546A
4.00 (101.60) to 5.00 (127.00)	Expander – Flare-Flare Clamp Fit	900547A

Note: Purchaser is responsible for all application, endurance and verification testing prior to production release.

Exhaust Accessories

Flexible Hose Cut to Length

- Exclusive cut feature provides locked ends with no metal burrs
- Individual lengths of bulk material
- Measured as fully extended lengths

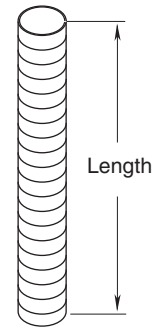
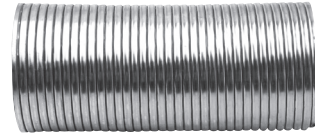

Diameter in (mm)	Length in (mm)	Galvanized Part Number	Stainless Part Number	Aluminized Part Number
3.00 (76.20)	12.00 (304.80)	—	89612K	—
3.00 (76.20)	18.00 (457.20)	89600K	89613K	—
3.00 (76.20)	24.00 (609.60)	89601K	89614K	—
3.00 (76.20)	36.00 (914.40)	89602K	89615K	—
3.50 (88.90)	12.00 (304.80)	—	89616K	—
3.50 (88.90)	18.00 (457.20)	89603K	89617K	—
3.50 (88.90)	24.00 (609.60)	89604K	89618K	—
3.50 (88.90)	36.00 (914.40)	89605K	89619K	—
4.00 (101.60)	12.00 (304.80)	90903K	—	—
4.00 (101.60)	18.00 (457.20)	89606K	89727K	89309K
4.00 (101.60)	24.00 (609.60)	89607K	89728K	89310K
4.00 (101.60)	36.00 (914.40)	89608K	89729K	89311K
4.00 (101.60)	48.00 (1219.20)	900357K	900358K	—
5.00 (127.00)	12.00 (304.80)	90902K	89730K	—
5.00 (127.00)	18.00 (457.20)	89609K	89731K	89313K
5.00 (127.00)	24.00 (609.60)	—	—	89314K
5.00 (127.00)	36.00 (914.40)	89611K	89733K	89701K
5.00 (127.00)	48.00 (1219.20)	900359K	—	—

Specifications subject to change without notice. See page 1-8 for cleaning chrome.
All parts listed are subject to lead time.

Exhaust Accessories

10' and 25' Flexible Hose

- Available in stainless, aluminized and galvanized steel
- Measured in a partially compressed state. You receive 10% more length than competitive products sold in fully extended lengths!
- Flex should be installed in a straight position and not be used as an elbow

Best

Stainless Steel PolyLock™

- Engineered to be cut to length
- Requires no tack welds to cut
- Will not unravel after cutting



Diameter in (mm)	10' Length Part Number		25' Length Part Number	
	Standard Flex	PolyLock™	Standard Flex	PolyLock™
2.00 (50.80)	89620K	–	–	–
2.50 (63.50)	89621K	–	89719K	–
3.00 (76.20)	89622K	–	89721K	–
3.50 (88.90)	89623K	–	89722K	–
4.00 (101.60)	89624K	89624P	89723K	89723P
5.00 (127.00)	89625K	89625P	89724K	89724P
6.00 (152.40)	89626K	–	89725K	–

Best

Stainless Steel Flex

- Engineered to provide maximum durability and corrosion resistance. Capable of withstanding high temperatures, such as those found in gas and diesel engine applications.



Better

Aluminized Flex

- Provides a high level of durability and oxidation resistance. Withstands high temperatures such as those found in diesel engine applications.



Economy

Galvanized Flex

- Durable hose with fair oxidation resistance. Capable of withstanding temperatures of up to 600 °F (316 °C). Suitable for light duty applications.

Diameter in (mm)	10' Length Part Number	25' Length Part Number
	Standard Flex	
3.00 (76.20)	90191K	–
3.50 (88.90)	90206K	–
4.00 (101.60)	89759K	89760K
5.00 (127.00)	89772K	89773K

Diameter in (mm)	10' Length Part Number	25' Length Part Number
	Standard Flex	Standard Flex
2.00 (50.80)	89640K	89708K
2.25 (57.15)	89648K	89709K
2.50 (63.50)	89641K	89710K
2.75 (69.85)	89647K	–
3.00 (76.20)	89642K	89712K
3.50 (88.90)	89643K	89713K
4.00 (101.60)	89644K	89714K
5.00 (127.00)	89645K	89715K
6.00 (152.40)	89646K	89716K

Exhaust Accessories

Elbows

15° Elbows

- For use in tight places where clearance is a problem
- 16 gauge aluminized steel

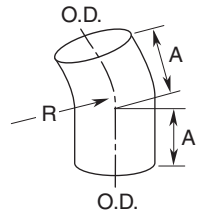

Diameter in (mm)	A Leg Length in (mm)	R Center Line Radius in (mm)	Aluminized Part Number
3.00 (76.20)	2.59 (65.79)	4.50 (114.30)	89130A
3.50 (88.90)	2.79 (70.87)	6.00 (152.40)	89131A
4.00 (101.60)	3.29 (83.57)	6.00 (152.40)	89132A
5.00 (127.00)	4.55 (115.57)	8.00 (203.20)	89133A

30° Elbows

- 16 gauge aluminized steel

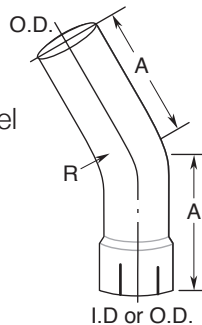

Diameter in (mm)	A Leg Length in (mm)	R Center Line Radius in (mm)	I.D. - O.D. Part Number	O.D. - O.D. Part Number
3.00 (76.20)	3.30 (93.82)	3.00 (76.20)	900162A	-
3.50 (88.90)	3.57 (90.67)	4.00 (101.60)	900072A	900076A
4.00 (101.60)	4.21 (106.93)	4.50 (114.30)	900073A	900077A
5.00 (127.00)	4.97 (126.24)	5.50 (139.70)	900074A	900078A

45° Elbows

- Bright, exceptional quality chrome or 16 gauge aluminized steel

Diameter in (mm)	A Leg Length in (mm)	R Center Line Radius in (mm)	I.D. - O.D.		O.D. - O.D.
			Aluminized Part Number	Chrome Part Number	Aluminized Part Number
2.00 (50.80)	4.16 (105.66)	4.00 (101.60)	89071A	-	89081A
2.25 (57.15)	4.26 (108.20)	4.25 (107.95)	89241A	-	89240A
2.50 (63.50)	4.26 (108.20)	4.25 (107.95)	-	-	89082A
2.75 (69.85)	5.03 (127.76)	5.50 (139.70)	89243A	-	89242A
3.00 (76.20)	5.50 (139.70)	6.00 (152.40)	89073A	-	89083A
3.50 (88.90)	6.00 (152.40)	6.00 (152.40)	-	-	900068A
3.50 (88.90)	10.00 (254.00)	6.00 (152.40)	89077A	-	89087A
4.00 (101.60)	6.50 (165.10)	6.00 (152.40)	89780A	89780C	89782A
4.00 (101.60)	11.00 (279.40)	6.00 (152.40)	89074A	89074C	89084A
4.50 (114.30)	7.27 (184.66)	6.69 (169.93)	90488A	-	900100A
5.00 (127.00)	7.28 (184.91)	5.50 (139.70)	-	89781C	89783A
5.00 (127.00)	15.00 (381.00)	8.00 (203.20)	89075A	89075C	89085A
6.00 (152.40)	17.65 (448.31)	10.00 (254.00)	89076A	-	89086A

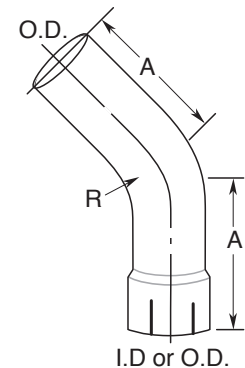

Specifications subject to change without notice. See page 1-8 for cleaning chrome.
All parts listed are subject to lead time.

Exhaust Accessories

Elbows

60° Elbows

- 16 gauge aluminized steel

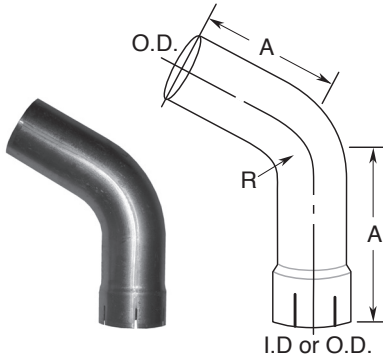

Diameter in (mm)	A Leg Length in (mm)	R Center Line Radius in (mm)	I.D. - O.D. Part Number	O.D. - O.D. Part Number
3.50 (88.90)	5.81 (147.57)	4.00 (101.60)	900080A	900084A
4.00 (101.60)	6.90 (175.26)	5.00 (127.00)	900081A	900085A
5.00 (127.00)	8.00 (203.20)	5.50 (139.70)	900082A	900086A

70° Elbows

- 16 gauge aluminized steel

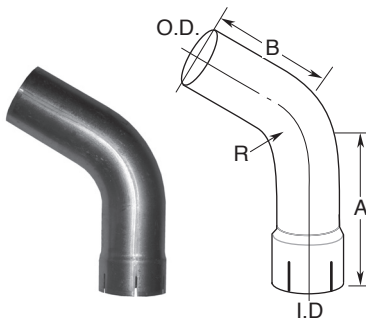

Diameter in (mm)	A Leg Length in (mm)	B Leg Length in (mm)	R Center Line Radius in (mm)	I.D. - O.D. Part Number	O.D. - O.D. Part Number
3.50 (88.90)	7.70 (195.58)	7.70 (195.58)	6.00 (152.40)	89237A	—
4.00 (101.60)	8.20 (208.28)	8.20 (208.28)	6.00 (152.40)	89238A	—
5.00 (127.00)	11.00 (279.40)	7.50 (190.50)	5.50 (139.70)	89239A	90465A

- Bright, exceptional quality chrome or 16 gauge aluminized steel

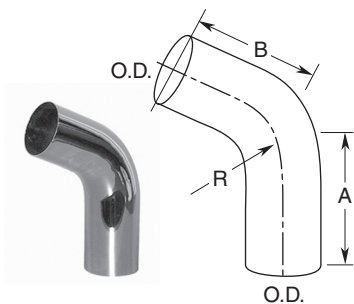

Diameter in (mm)	A Leg Length in (mm)	B Leg Length in (mm)	R Center Line Radius in (mm)	Aluminized Part Number	Chrome Part Number
5.00 (127.00)*	11.00 (279.40)	7.50 (190.50)	5.50 (139.70)	90465A	90465C

* Peterbilt P/N 14-01726

Exhaust Accessories

Elbows

90° Elbows

- Bright, exceptional quality chrome or 16 gauge aluminized steel

Diameter in (mm)	A Leg Length in (mm)	B Leg Length in (mm)	R Center Line Radius in (mm)	O.D. - O.D.	
				Aluminized Part Number	Chrome Part Number
2.00 (50.80)	9.00 (228.60)	9.00 (228.60)	4.00 (101.60)	89110A	—
2.25 (57.15)	9.00 (228.60)	9.00 (228.60)	4.25 (107.95)	89231A	—
2.50 (63.50)	9.00 (228.60)	9.00 (228.60)	4.25 (107.95)	89111A	—
2.75 (69.85)	9.00 (228.60)	9.00 (228.60)	5.50 (139.70)	89233A	—
3.00 (76.20)	9.00 (228.60)	9.00 (228.60)	6.00 (152.40)	89113A	—
3.00 (76.20)	13.70 (347.98)	13.70 (347.98)	6.00 (152.40)	89234A	—
3.50 (88.90)	9.00 (228.60)	9.00 (228.60)	6.00 (152.40)	89235A	—
3.50 (88.90)	11.00 (279.40)	11.00 (279.40)	6.00 (152.40)	900058A	—
3.50 (88.90)	15.00 (381.00)	15.00 (381.00)	6.00 (152.40)	89114A	—
4.00 (101.60)	10.00 (254.00)	10.00 (254.00)	6.00 (152.40)	89124A	—
4.00 (101.60)	12.00 (304.80)	12.00 (304.80)	6.00 (152.40)	89116A	—
4.00 (101.60)	14.70 (373.38)	14.70 (373.38)	6.00 (152.40)	900059A	—
4.00 (101.60)	18.00 (457.20)	18.00 (457.20)	6.00 (152.40)	89115A	89115C
4.00 (101.60)	22.70 (576.58)	29.70 (754.38)	6.00 (152.40)	89125A	—
4.50 (114.30)	11.00 (279.40)	11.00 (279.40)	6.69 (169.93)	900098A	—
5.00 (127.00)	10.00 (254.00)	10.00 (254.00)	8.00 (203.20)	89126A	—
5.00 (127.00)	13.00 (330.20)	13.00 (330.20)	8.00 (203.20)	900062A	—
5.00 (127.00)	15.00 (381.00)	15.00 (381.00)	8.00 (203.20)	89117A	89117C
5.00 (127.00)	17.25 (438.15)	17.25 (438.15)	8.00 (203.20)	89118A	—
5.00 (127.00)	22.50 (571.50)	22.50 (571.50)	8.00 (203.20)	89127A	—
6.00 (152.40)	15.00 (381.00)	15.00 (381.00)	10.00 (254.00)	900063A	—
6.00 (152.40)	20.00 (508.00)	20.00 (508.00)	10.00 (254.00)	89119A	—

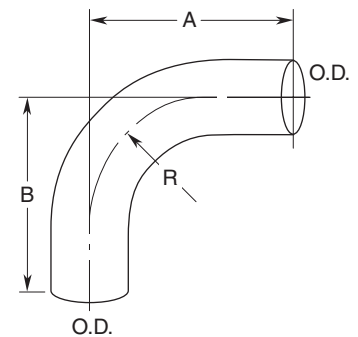

Specifications subject to change without notice. See page 1-8 for cleaning chrome.
All parts listed are subject to lead time.

Exhaust Accessories

Elbows

90° Short Radius Elbows

- For use in tight places where clearance is a problem
- Bright, exceptional quality chrome or 16 gauge aluminized steel

Diameter in (mm)	A Leg Length in (mm)	B Leg Length in (mm)	R Center Line Radius in (mm)	O.D. - O.D.	
				Aluminized Part Number	Chrome Part Number
3.00 (76.20)	3.50 (88.90)	3.50 (88.90)	3.00 (76.20)	89091A	—
3.00 (76.20)	6.00 (152.40)	6.00 (152.40)	3.00 (76.20)	89090A	—
3.50 (88.90)	4.50 (114.30)	4.50 (114.30)	4.00 (101.60)	89093A	—
3.50 (88.90)	8.00 (203.20)	8.00 (203.20)	4.00 (101.60)	89092A	—
4.00 (101.60)	5.00 (127.00)	5.00 (127.00)	4.50 (114.30)	89095A	—
4.00 (101.60)	6.50 (165.10)	6.50 (165.10)	4.50 (114.30)	90822A	—
4.00 (101.60)	8.50 (215.90)	8.50 (215.90)	4.50 (114.30)	89094A	—
4.00 (101.60)	7.70 (195.58)	9.70 (246.38)	4.50 (114.30)	90889A	—
4.00 (101.60)	9.00 (228.60)	15.00 (381.00)	4.50 (114.30)	89925A	—
4.50 (114.30)	6.00 (152.40)	6.00 (152.40)	5.50 (139.70)	900099A	—
5.00 (127.00)	6.00 (152.40)	6.00 (152.40)	5.50 (139.70)	89097A	—
5.00 (127.00)	6.50 (165.10)	6.50 (165.10)	5.50 (139.70)	—	90455C
5.00 (127.00)	7.50 (190.50)	13.50 (342.90)	5.50 (139.70)	89926A	—
5.00 (127.00)	9.70 (246.38)	15.70 (398.78)	5.50 (139.70)	89123A	—
5.00 (127.00)	10.50 (266.70)	10.50 (266.70)	5.50 (139.70)	89096A	—
6.00 (152.40)	6.50 (165.10)	6.50 (165.10)	6.00 (152.40)	89236A	—

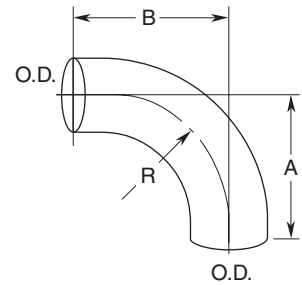

Exhaust Accessories

Elbows

90° Elbows

- One end O.D., one end I.D. slotted
- Bright, exceptional quality chrome or 16 gauge aluminized steel

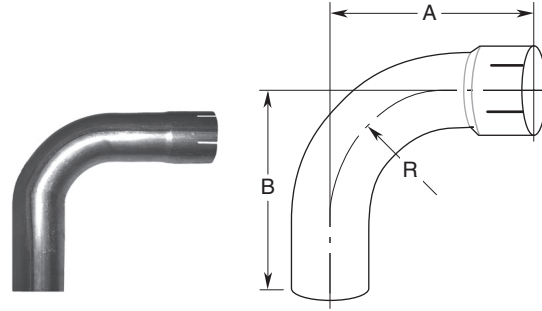

Diameter in (mm)	A Leg Length in (mm)	B Leg Length in (mm)	R Center Line Radius	I.D. - O.D.	
				Aluminized Part Number	Chrome Part Number
2.00 (50.80)	6.50 (165.10)	6.50 (165.10)	4.00 (101.60)	900046A	—
2.00 (50.80)	9.00 (228.60)	9.00 (228.60)	4.00 (101.60)	89098A	—
2.25 (57.15)	9.00 (228.60)	9.00 (228.60)	4.25 (107.95)	89230A	—
2.50 (63.50)	6.75 (171.45)	6.75 (171.45)	4.25 (107.95)	900048A	—
2.50 (63.50)	9.00 (228.60)	9.00 (228.60)	4.25 (107.95)	89099A	—
2.75 (69.85)	6.50 (165.10)	6.50 (165.10)	3.75 (95.25)	900050A	—
2.75 (69.85)	9.00 (228.60)	9.00 (228.60)	5.50 (139.70)	89232A	—
3.00 (76.20)	9.00 (228.60)	9.00 (228.60)	6.00 (152.40)	89101A	—
3.00 (76.20)	11.00 (279.40)	11.00 (279.40)	6.00 (152.40)	900052A	—
3.00 (76.20)	13.70 (347.98)	13.70 (347.98)	6.00 (152.40)	89102A	—
3.50 (88.90)	9.00 (228.60)	9.00 (228.60)	6.00 (152.40)	89103A	—
3.50 (88.90)	11.00 (279.40)	11.00 (279.40)	6.00 (152.40)	900053A	—
3.50 (88.90)	15.00 (381.00)	15.00 (381.00)	6.00 (152.40)	89104A	—
4.00 (101.60)	6.50 (165.10)	6.50 (165.10)	4.50 (114.30)	89923A*	89923C
4.00 (101.60)	8.50 (215.90)	8.50 (215.90)	4.50 (114.30)	900055A	—
4.00 (101.60)	10.00 (254.00)	10.00 (254.00)	6.00 (152.40)	89105A	89105C
4.00 (101.60)	12.00 (304.80)	12.00 (304.80)	6.00 (152.40)	90847A	90847C
4.00 (101.60)	14.70 (373.38)	14.70 (373.38)	6.00 (152.40)	900056A	—
4.00 (101.60)	18.00 (457.20)	18.00 (457.20)	6.00 (152.40)	89106A	89106C
4.00 (101.60)	7.70 (195.58)	9.70 (246.38)	4.50 (114.30)	90562A	—
4.00 (101.60)	22.70 (576.58)	29.70 (754.38)	6.00 (152.40)	90459A	—

Specifications subject to change without notice. See page 1-8 for cleaning chrome.
All parts listed are subject to lead time.

Exhaust Accessories

Elbows

90° Elbows

- One end O.D., one end I.D. slotted
- Bright, exceptional quality chrome or 16 gauge aluminized steel

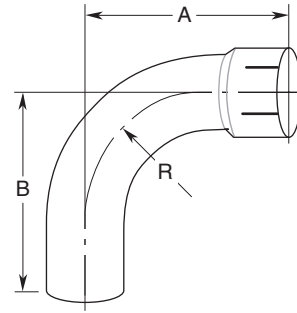

Diameter in (mm)	A Leg Length in (mm)	B Leg Length in (mm)	R Center Line Radius	I.D. - O.D.	
				Aluminized Part Number	Chrome Part Number
5.00 (127.00)	8.50 (215.90)	8.50 (215.90)	5.50 (139.70)	89924A	89924C
5.00 (127.00)	10.00 (254.00)	10.00 (254.00)	8.00 (203.20)	89784A	89784C
5.00 (127.00)	13.00 (330.20)	13.00 (330.20)	8.00 (203.20)	90859A	90859C
5.00 (127.00)	15.00 (381.00)	15.00 (381.00)	8.00 (203.20)	89107A	89107C
5.00 (127.00)	17.25 (438.15)	17.25 (438.15)	8.00 (203.20)	89108A	–
5.00 (127.00)	22.50 (571.50)	22.50 (571.50)	8.00 (203.20)	90460A	–
5.00 (127.00)	10.00 (254.00)	22.00 (558.80)	8.00 (203.20)	90082A	–
6.00 (152.40)	15.00 (381.00)	15.00 (381.00)	10.00 (254.00)	900057A	–
6.00 (152.40)	20.00 (508.00)	20.00 (508.00)	10.00 (254.00)	89109A	89109C

Exhaust Accessories

Elbows

45° Stainless Steel Elbows

- 3.5" (88.90 mm) to 5.0" (127.00 mm) O.D.
- Stainless steel
- O.D.-O.D. sized for use with I.D. connectors
- Small radius bends for compact installations

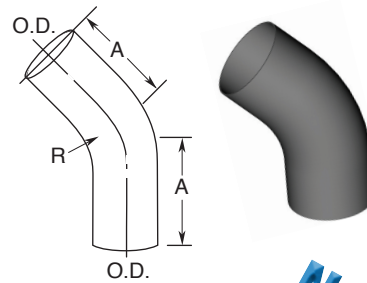

New!

Diameter in (mm)	Description	A Leg Length in (mm)	B Leg Length in (mm)	R Center Line Radius	O.D. - O.D.
					Stainless Steel Part Number
3.50 (88.90)	O.D.-O.D.	4.00 (101.60)	4.00 (101.60)	5.00 (127.00)	900533A
4.00 (101.60)	O.D.-O.D.	4.00 (101.60)	4.00 (101.60)	5.00 (127.00)	900534A
5.00 (127.00)	O.D.-O.D.	4.50 (114.30)	4.50 (114.30)	6.00 (152.40)	900535A

90° Stainless Steel Elbows

- 3.5" (88.90 mm) to 5.0" (127.00 mm) O.D.
- Stainless steel
- O.D.-O.D. sized for use with I.D. connectors, flare-flare and flare-Marmon connectors for clamping
- O.D.-I.D. sized for post A/T
- Small radius bends for compact installations

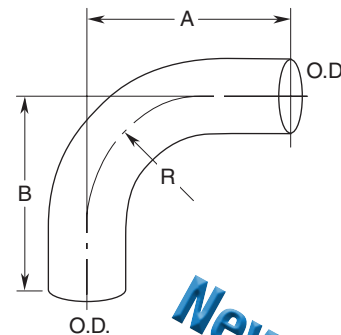

New!

Diameter in (mm)	Description	A Leg Length in (mm)	B Leg Length in (mm)	R Center Line Radius	O.D. - O.D.
					Stainless Steel Part Number
3.50 (88.90)	O.D.-O.D.	7.00 (177.80)	7.00 (177.80)	5.00 (127.00)	900527A
4.00 (101.60)	O.D.-O.D.	7.00 (177.80)	7.00 (177.80)	5.00 (127.00)	900528A
5.00 (127.00)	O.D.-O.D.	8.00 (203.20)	8.00 (203.20)	6.00 (152.40)	900529A
3.50 (88.90)	Flare-Flare	7.00 (177.80)	7.00 (177.80)	5.00 (127.00)	900551A
4.00 (101.60)	Flare-Flare	7.00 (177.80)	7.00 (177.80)	5.00 (127.00)	900552A
5.00 (127.00)	Flare-Flare	8.00 (203.20)	8.00 (203.20)	6.00 (152.40)	900553A
3.50 (88.90)	Flare-Marmon	7.00 (177.80)	8.00 (203.20)	5.00 (127.00)	900557A
4.00 (101.60)	Flare-Marmon	7.00 (177.80)	8.00 (203.20)	5.00 (127.00)	900558A
5.00 (127.00)	Flare-Marmon	8.00 (203.20)	8.75 (222.25)	6.00 (152.40)	900559A
3.50 (88.90)	O.D.-I.D.	7.00 (177.80)	7.00 (177.80)	5.00 (127.00)	900573A
4.00 (101.60)	O.D.-I.D.	7.00 (177.80)	7.00 (177.80)	5.00 (127.00)	900574A
5.00 (127.00)	O.D.-I.D.	8.00 (203.20)	8.00 (203.20)	6.00 (152.40)	900575A

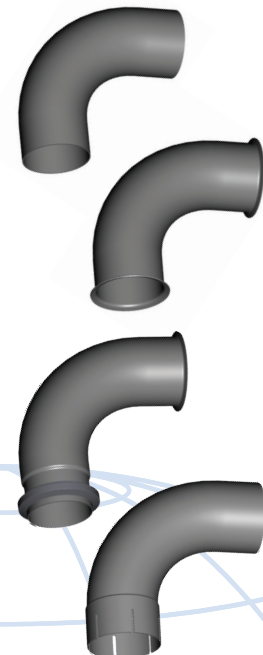

Specifications subject to change without notice. See page 1-8 for cleaning chrome.
All parts listed are subject to lead time.

Replacement Elbow for Freightliner® Series

- Freightliner MY 2002 - Century Series S/T Replacement Mufflers and Muffler Mounting Elbows
- Top quality construction that meets or exceeds OE requirements
- First-fit aftermarket product at an affordable price
- Use our 90877A clamps with muffler and/or elbow

Part Number

Q618142

Dimensions

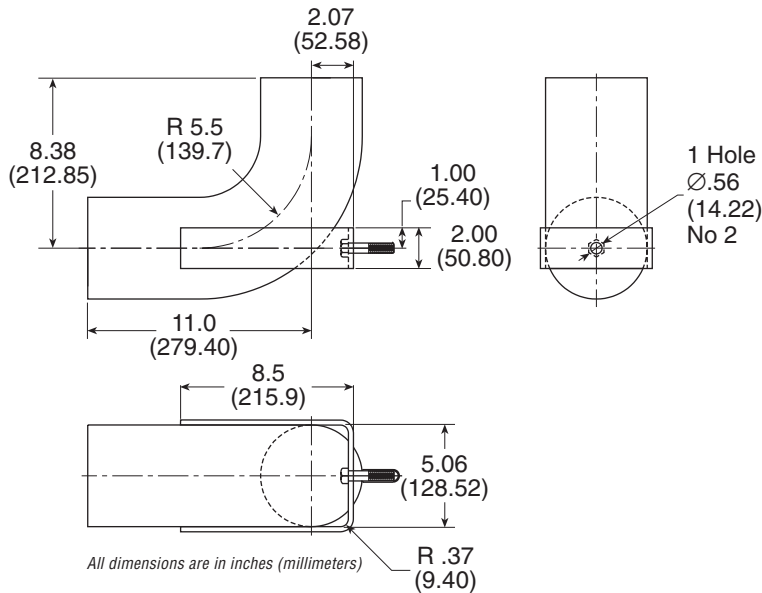

Exhaust Accessories

Tubes

Tube Expander

- Rounds muffler and tubing ends to original size and shape with ease
- Removes U-bolt crimps
- Saves exhaust installation time
- Operates with impact wrench
- Not designed to swage tubing

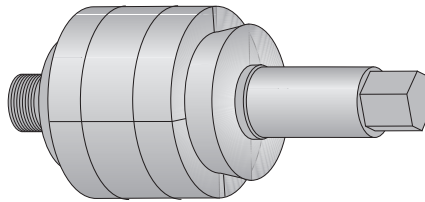

Tube Size in (mm)	Aluminized Part Number
4.00 (101.60)	90907K

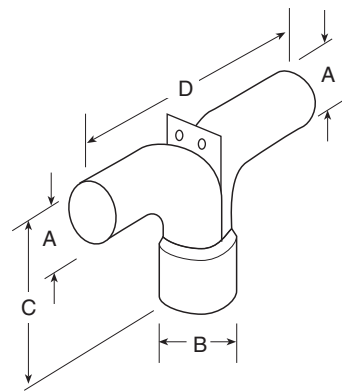

Splitter Tee Adapter Tube

- Converts a single system exhaust pipe into a dual system
- See Special Muffler section for Splitter Tee Mufflers

A (O.D.) in (mm)	B (I.D.) in (mm)	C in (mm)	D in (mm)	Aluminized Part Number	Chrome Part Number
4.00 (101.60)	4.00 (101.60)	11.25 (285.75)	16.00 (406.40)	89940A	—
5.00 (127.00)	5.00 (127.00)	14.00 (355.60)	25.00 (635.00)	89950A	89950C



Conventional Wye Tube

- O.E. replacement on various models of trucks
- Can be used to convert dual exhaust to single
- See Special Muffler section for Wye Connector Mufflers

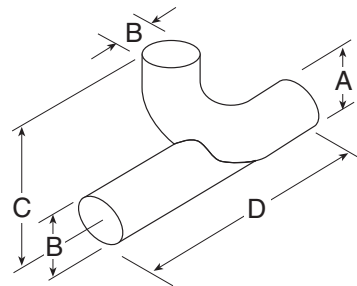

A (O.D.) in (mm)	B (I.D.) in (mm)	C in (mm)	D in (mm)	Part Number
4.00 (101.60)	3.00 (76.20)	9.00 (228.60)	15.00 (381.00)	89942A
4.00 (101.60)	4.00 (101.60)	7.00 (177.80)	15.00 (381.00)	89941A
5.00 (127.00)	5.00 (127.00)	9.00 (228.60)	15.00 (381.00)	89951A



Specifications subject to change without notice. See page 1-8 for cleaning chrome.
All parts listed are subject to lead time.

Exhaust Accessories

Tubes

Straight Tubing

- 3.0" (76.20 mm) to 5.0" (127.00 mm) O.D. stainless steel
- 409/439 stainless steel
- Length 5.0' (1.5 m)
- Drawing quality for bending capability

Size in (mm)	Description	Part Number
3.50 (88.90)	5' (1.5 m) Straight Stainless Steel Tube (bendable)	900539A
4.00 (101.60)	5' (1.5 m) Straight Stainless Steel Tube (bendable)	900540A
5.00 (127.00)	5' (1.5 m) Straight Stainless Steel Tube (bendable)	900541A

Note: Purchaser is responsible for all application, endurance and verification testing prior to production release.



High Performance Flex Tubes

- 3.5" (88.90 mm) to 5.0" (127.00 mm) stainless steel
- Leak proof corrugated flex section
- External braid for long life
- Flared and Marmon adapters connections
- Internal liner option for heat retention available

Size in (mm)	Description	Part Number
3.50 (88.90)	High Performance Flex	900521A
4.00 (101.60)	High Performance Flex	900522A
5.00 (127.00)	High Performance Flex	900523A
3.50 (88.90)	High Performance Flex with Retention Liner	900570A
4.00 (101.60)	High Performance Flex with Retention Liner	900571A
5.00 (127.00)	High Performance Flex with Retention Liner	900572A

Note: Purchaser is responsible for all application, endurance and verification testing prior to production release. Flex tubes listed on this page are not intended for applications requiring rotational displacement. These applications require a specially designed flex tube.



Exhaust Accessories

Special Tubes



Special Bluebird™ Tubes

- For use in specialized applications
- 16 gauge aluminized steel

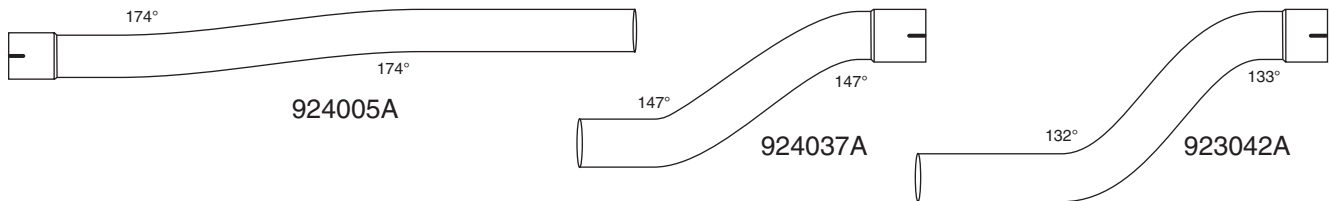

Bluebird Part Number	Diameter in (mm)	Application	Part Number
1332386, 1477629, 1477637, 1477645	3.00 (76.20)	Exhaust Pipe	924005A
1357342, 1357359, 1410133	4.00 (101.60)	Tail Pipe	924037A
1477538	4.00 (101.60)	Tail Pipe	923042A

Special Ford™ Tubes

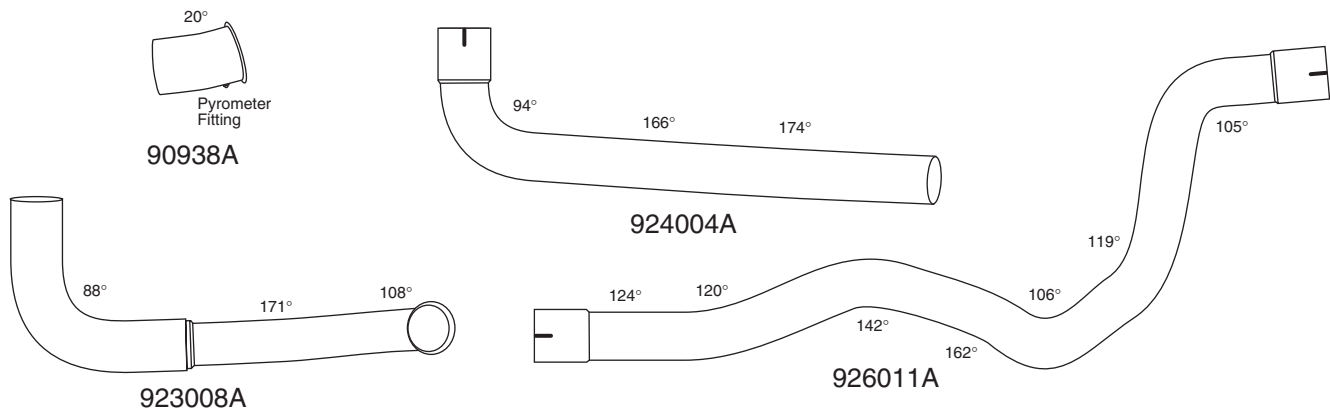

Ford Part Number	Diameter in (mm)	Application	Part Number
D8HZ5246M	5.00 (127.00)	NTC Turbo	90938A
E7HZ-5246N	4.00 (101.60)	Exhaust Pipe	924004A
E7HZ-5255A	4.00 (101.60)	School Bus Tail Pipe	926011A
E2HZ-5A231A, E7HZ-5246G	3.50 (88.90)	Exhaust Pipe	923008A

Specifications subject to change without notice. See page 1-8 for cleaning chrome.
All parts listed are subject to lead time.

Exhaust Accessories

Special Tubes

Special Freightliner® Tubes

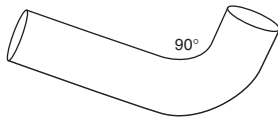

90983A

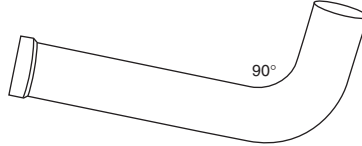

90984C

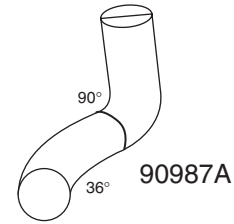

90987A

Freightliner Part Number	Diameter in (mm)	Application	Aluminized Part Number	Chrome Part Number
04-09586-017	5.00 (127.00)	Exhaust Elbow	90983A	–
04-09833-007	5.00 (127.00)	Exhaust Elbow	–	90984C
04-15653-000	5.00 (127.00)	RH Vertical Elbow	90987A	–

Special GMC®/Chevrolet® Tubes

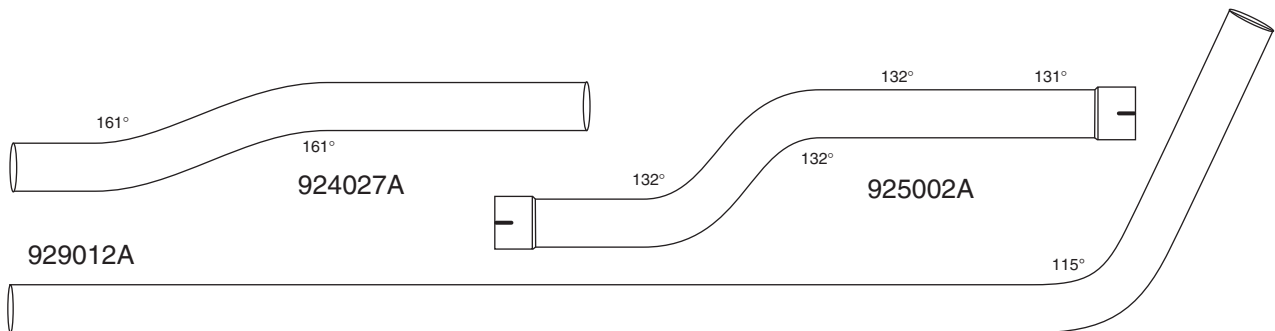

GM Part Number	Diameter in (mm)	Application	Part Number
2049060	4.00 (101.60)	Tail Pipe	929012A
2069199	4.00 (101.60)	Tail Pipe	924027A
2082829	4.00 (101.60)	Over Axle Bus Pipe	925002A

Exhaust Accessories

Special Tubes

Special International®/Navistar® Tubes

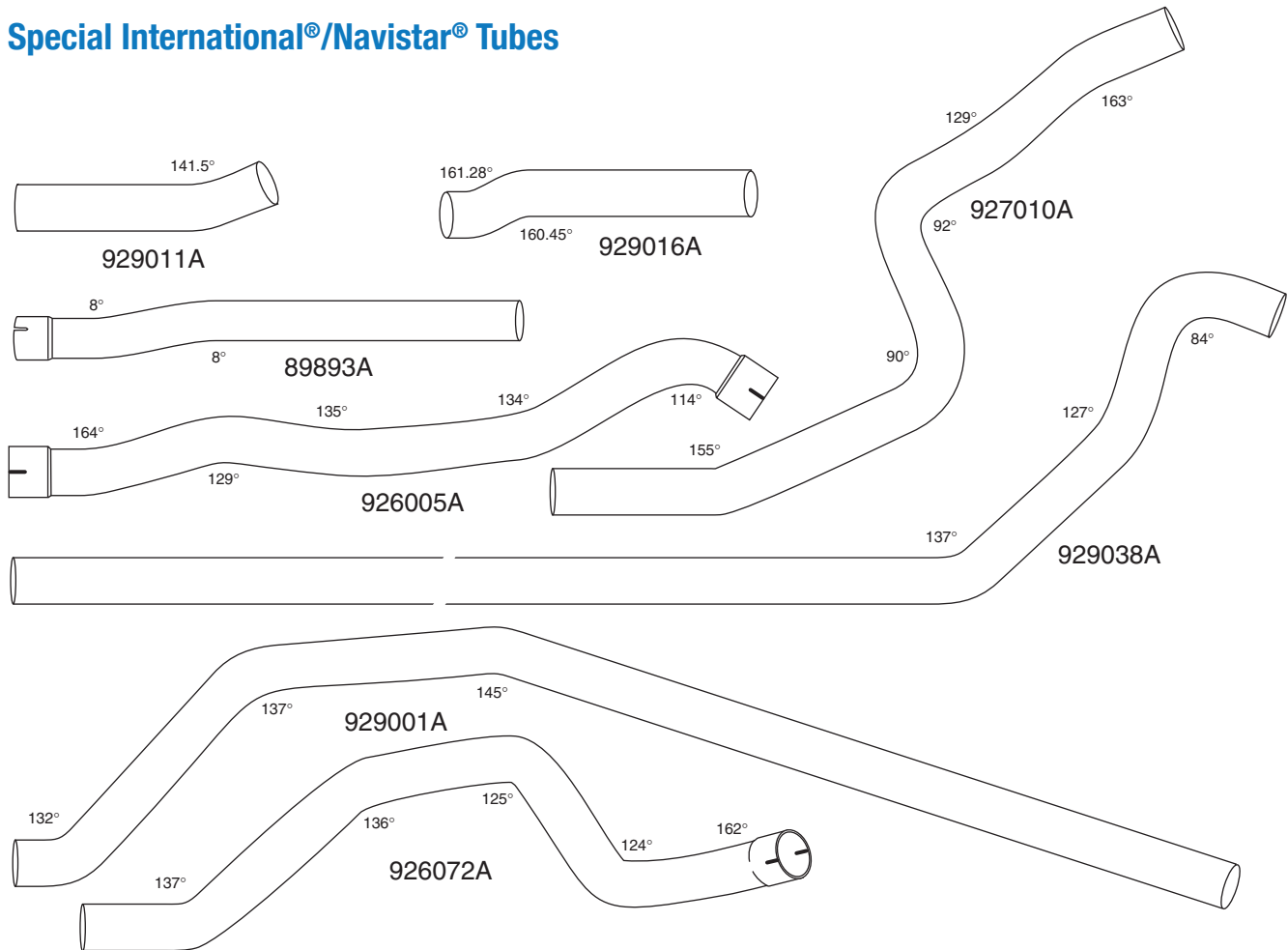

Navistar Part Number	Diameter in (mm)	Application	Part Number
1668841C2, 1668843C1, 1668845C1, 1668846C1, 482612C2, 482614C2, 511343C1	4.00 (101.60)	School Bus Tail Pipe	929016A
532395C1	4.00 (101.60)	S Series Vertical Stack	89893A
1608381C1, 1608681C1	4.00 (101.60)	Over Axle Pipe	926072A
482168C1, 482168C4	4.00 (101.60)	School Bus Axle Crossover Pipe	926005A
1610293C3	4.00 (101.60)	School Bus Tail Pipe	927010A
1610299C3	4.00 (101.60)	School Bus Tail Pipe	929001A
1618487C2, 1618490C2, 1688108C1, 1688109C1, 1688111C1	4.00 (101.60)	Tail Pipe	929038A
1678071C1, 1678074C1, 482616C1, 482618C1, 482620C1, 482622C1, 482624C1, 482626C1, 577265C1	4.00 (101.60)	School Bus Tail Pipe	929011A

Specifications subject to change without notice. See page 1-8 for cleaning chrome.
All parts listed are subject to lead time.

Exhaust Accessories

Special Tubes

Special International®/Navistar® Tubes

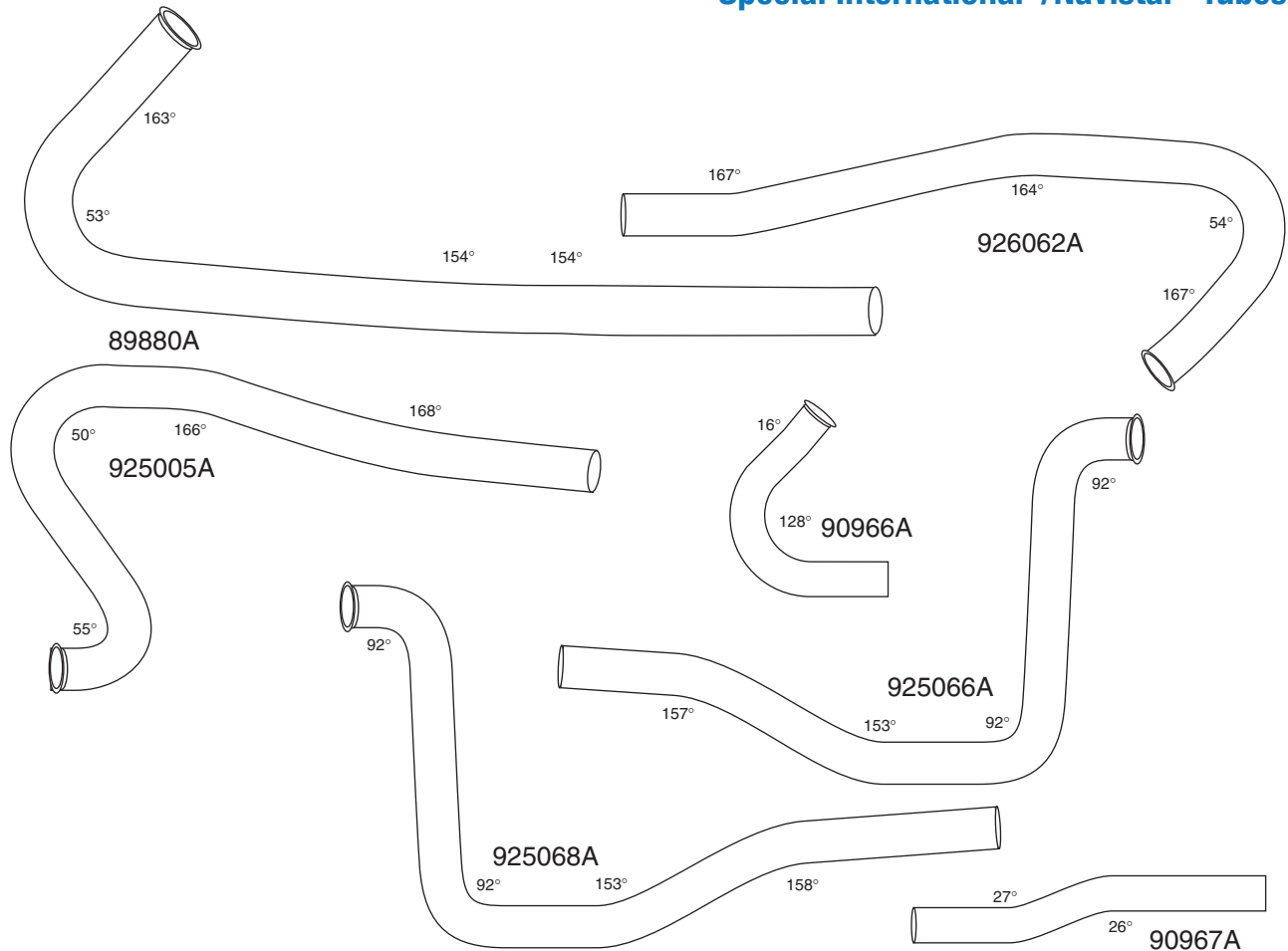

Navistar Part Number	Diameter in (mm)	Application	Part Number
499388C1	3.50 (88.90)	Exhaust Pipe	89880A
482174C1	3.50 (88.90)	Exhaust Pipe	926062A
587519C2	3.50 (88.90)	Manifold Elbow	90966A
587521C2	3.50 (88.90)	Intermediate Elbow	90967A
1653532C1, 1668838C1	3.50 (88.90)	Exhaust Pipe	925005A
2004557C1	3.50 (88.90)	School Bus Tail Pipe	925066A
2013204C1	3.50 (88.90)	Exhaust Pipe	925068A

Exhaust Accessories

Special Tubes

Special International®/Navistar® Tubes

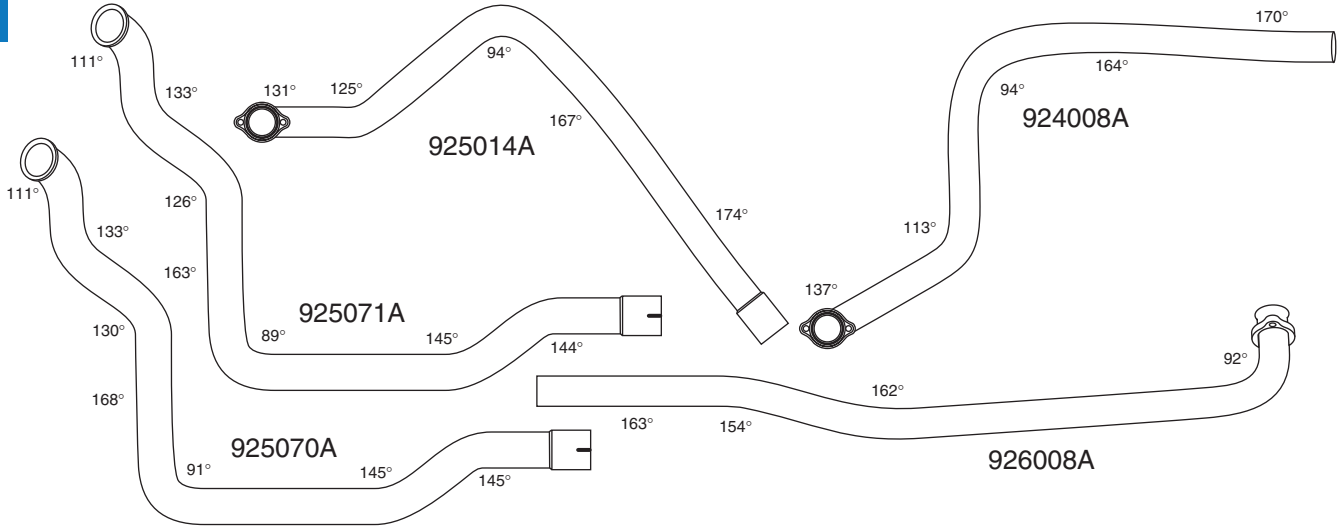

Navistar Part Number	Diameter in (mm)	Application	Part Number
2029954C1, 3521589C1	3.00 (76.20)	School Bus Tail Pipe	925071A
3521583C1	3.00 (76.20)	Exhaust Pipe	925070A
591593C91, 593784C1	2.50 (63.50)	Exhaust Pipe	925014A
591595C91, 591595C92, 593782C91, 593783C11	2.50 (63.50)	School Bus Tail Pipe	926008A
1666966C2	2.50 (63.50)	Exhaust Pipe	924008A

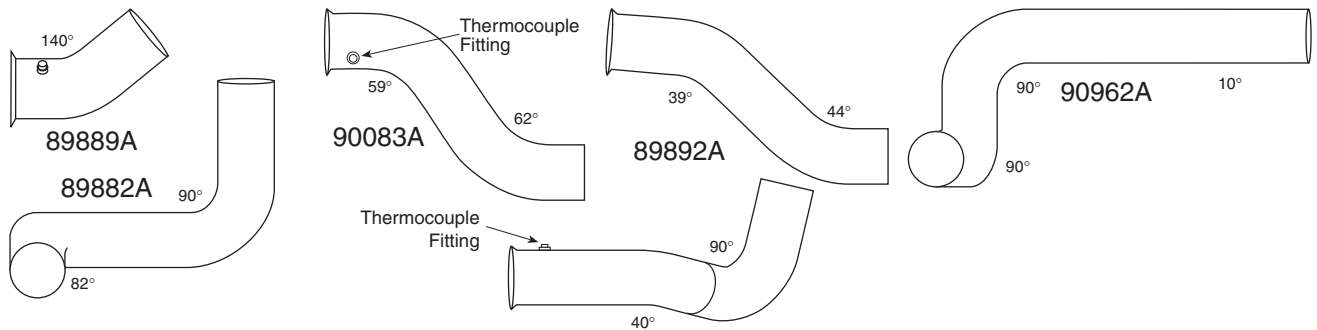

Navistar Part Number	Diameter in (mm)	Application	Part Number
1652937C1	5.00 (127.00)	Turbo Elbow	89889A
1657101C1	5.00 (127.00)	Intermediate Elbow	89882A
1673907C1	5.00 (127.00)	Turbo Elbow	90083A
475306C2	5.00 (127.00)	Adapter	89892A
532383C1	5.00 (127.00)	Turbo Elbow	90962A
582167C1	5.00 (127.00)	Turbo Elbow	90823A

Specifications subject to change without notice. See page 1-8 for cleaning chrome.
All parts listed are subject to lead time.

Exhaust Accessories

Special Tubes

Special Kenworth™ Tubes

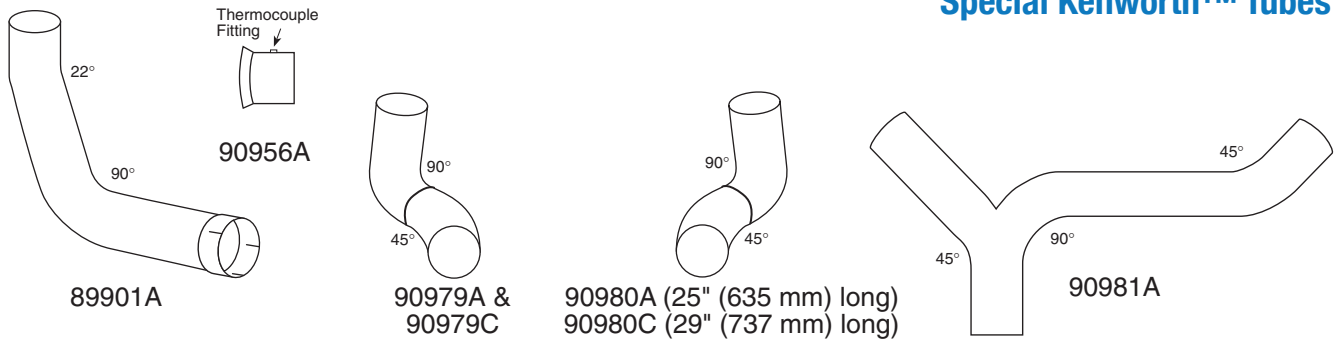

Kenworth Part Number	Diameter in (mm)	Application	Aluminized Part Number	Chrome Part Number
K130-166	5.00 (127.00)	Turbo Adapter	90956A	—
K180-10742R	5.00 (127.00)	RH Elbow	89901A	—
K180-14764R	5.00 (127.00)	RH Elbow	90979A	90979C
K180-14764L	5.00 (127.00)	LH Elbow	90980A	90980C
K180-14766	5.00 (127.00)	“Y” Pipe	90981A	—

Exhaust Accessories

Special Tubes

Special Mack® Tubes

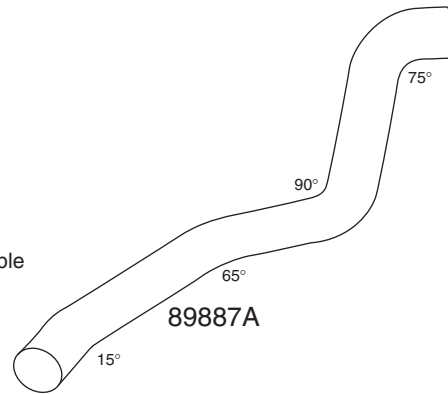
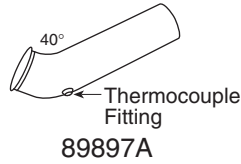

Mack Part Number	Diameter in (mm)	Application	Part Number
4ME32603	4.00 (101.60)	R w/ RD Fuel Tank	90922A
4ME21698	4.00 (101.60)	R & RD Models	89897A
4ME32612	4.00 (101.60)	R Model Intermediate	89887A

Special Peterbilt™ Tubes

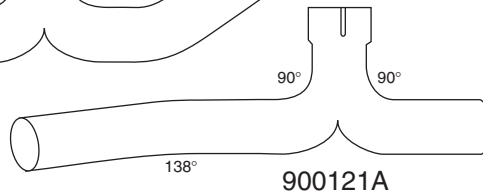
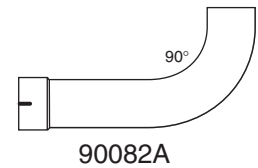
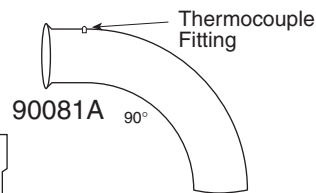
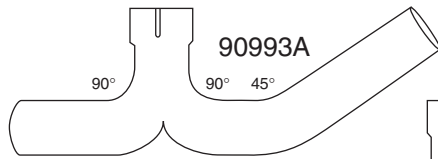
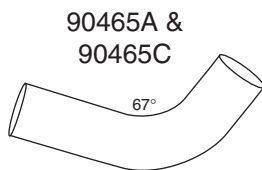

Peterbilt Part Number	Diameter in (mm)	Application	Aluminized Part Number	Chrome Part Number
14-01726	5.00 (127.00)		90465A	90465C
14-04055	5.00 (127.00)	Intermediate Elbow	90993A	—
14-09456	5.00 (127.00)	See I.D. - O.D. Elbow, page 2-25	90082A	—
14-11054	5.00 (127.00)	Turbo Elbow	90081A	—
14-13055	5.00 (127.00)	“Y” Pipe	900121A	—

Special Western Star® Tube

Western Star Part Number	Diameter in (mm)	Application	Part Number
23527-3440	5.00 (127.00)	Exhaust Pipe	900123A

Specifications subject to change without notice. See page 1-8 for cleaning chrome.
All parts listed are subject to lead time.

Exhaust Accessories

Stack Pipes

- Bright, exceptional quality chrome or 16 gauge aluminized steel



Straight Tubes

Straight Stacks

Curved Stacks

Mitered West Coast Stacks

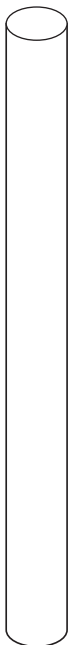

O.D.



**I.D.
Slotted**



**I.D.
Slotted**



O.D.

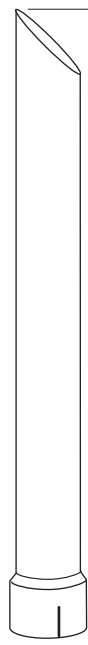

I.D.

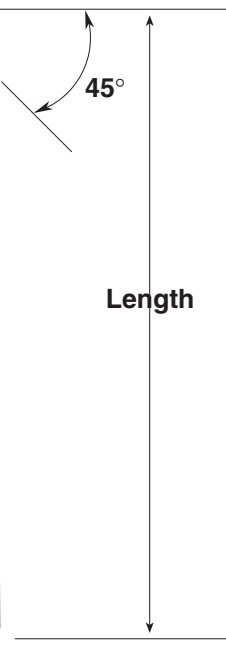

Length

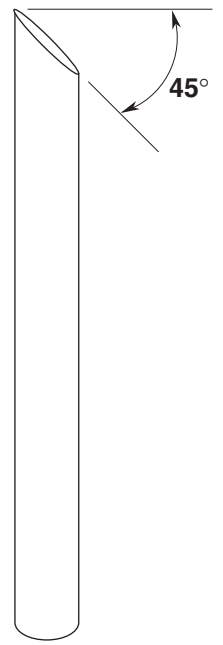

O.D.

Exhaust Accessories

Stack Pipes

Diameter in (mm)	Length in (mm)	Part Number										
		Straight Stack Pipes				Curved Stack Pipes				Mitered Stack Pipes		
		I.D.		O.D.		I.D.		O.D.		I.D.	O.D.	
		Alumi- nized	Chrome Plated	Straight Tubes		Alumi- nized	Chrome Plated	Alumi- nized	Chrome Plated	Alumi- nized	Chrome Plated	Chrome Plated
Alumi- nized	Chrome Plated											
3.00 (76.20)	18.00 (457.20)	89211A	—	—	—	—	—	—	—	—	—	—
3.00 (76.20)	24.00 (609.60)	89212A	—	—	89005C	—	—	89035A	89035C	—	—	—
3.00 (76.20)	36.00 (914.40)	89020A	89020C	89006A	89006C	89050A	89050C	89036A	89036C	—	—	—
3.00 (76.20)	48.00 (1219.20)	89021A	89021C	—	—	89051A	89051C	89037A	89037C	—	—	—
3.00 (76.20)	60.00 (1524.00)	89213A	—	—	—	925051A	925051C	900088A	900088C	—	—	—
3.5 (88.90)	31.00 (787.40)	—	—	—	—	—	Q646112	—	—	—	—	—
3.50 (88.90)	18.00 (457.20)	89214A	—	—	—	—	—	—	—	—	—	—
3.50 (88.90)	24.00 (609.60)	89022A	—	—	—	89052A	89052C	89040A	—	—	—	—
3.50 (88.90)	36.00 (914.40)	89023A	89023C	—	—	89053A	89053C	89041A	—	—	—	—
3.50 (88.90)	48.00 (1219.20)	89024A	—	—	—	89054A	89054C	89042A	—	—	—	—
3.50 (88.90)	60.00 (1524.00)	89215A	—	—	—	89225A	89225C	89221A	89221C	—	—	—
4.00 (101.60)	17.50 (444.50)	—	—	—	—	89145A	89145C	89155A	89155C	—	—	—
4.00 (101.60)	18.00 (457.20)	89216A	—	—	—	—	—	—	—	89906C	89921C	—
4.00 (101.60)	24.00 (609.60)	89025A	—	—	—	89055A	89055C	89043A	89043C	—	—	—
4.00 (101.60)	36.00 (914.40)	89026A	89026C	89014A	—	89056A	89056C	89044A	—	—	—	—
4.00 (101.60)	48.00 (1219.20)	89027A	89027C	89015A	—	89057A	89057C	89045A	89045C	90595C	—	—
4.00 (101.60)	60.00 (1524.00)	89217A	89217C	89205A	—	89226A	89226C	89222A	89222C	—	—	—
4.00 (101.60)	72.00 (1828.80)	—	—	89916A	89916C	89985A	89985C	89293A	89293C	—	—	—
4.00 (101.60)	84.00 (2133.60)	—	—	—	—	—	89986C	—	89294C	—	—	—
4.00 (101.60)	96.00 (2438.40)	—	—	—	—	—	89987C	—	89295C	—	—	—
4.00 (101.60)	108.00 (2743.20)	—	—	—	—	—	900089C	—	900090C	—	—	—
4.00 (101.60)	120.00 (3048.00)	90906A	—	—	—	—	—	—	—	—	—	—
4.50 (114.30)	17.50 (444.50)	—	—	—	—	90563A	—	—	—	—	—	—
4.50 (114.30)	27.50 (698.50)	90552A	—	—	—	—	—	—	—	—	—	—
4.50 (114.30)	69.00 (1752.60)	—	—	—	—	—	Q645633	—	—	—	—	—

Specifications subject to change without notice. See page 1-8 for cleaning chrome.
All parts listed are subject to lead time.

Exhaust Accessories

Stack Pipes

Diameter in (mm)	Length in (mm)	Part Number									
		Straight Stack Pipes				Curved Stack Pipes				Mitered Stack Pipes	
		I.D.		O.D.		I.D.		O.D.		I.D.	O.D.
		Alumi- nized	Chrome Plated	Straight Tubes		Alumi- nized	Chrome Plated	Alumi- nized	Chrome Plated	Alumi- nized	Chrome Plated
5.00 (127.00)	18.00 (457.20)			89218.A	89218C						
5.00 (127.00)	24.00 (609.60)	89028A	–	89016A	89016C	89058A	89058C	89046A	89046C	–	–
5.00 (127.00)	36.00 (914.40)	89029A	89029C	89017A	89017C	89059A	–	89047A	–	–	89993C
5.00 (127.00)	48.00 (1219.20)	89030A	89030C	89018A	–	89060A	89060C	89048A	–	–	89994C
5.00 (127.00)	54.00 (1371.60)	–	–	–	90605C	–	–	–	89997C	–	–
5.00 (127.00)	60.00 (1524.00)	89031A	89031C	89019A	89019C	89227A	89227C	89049A	–	90439C	90438C
5.00 (127.00)	64.00 (1625.60)	–	–	–	–	–	–	–	89999C	–	–
5.00 (127.00)	72.00 (1828.80)	89920A	89920C	–	89918C	–	89988C	89296A	89296C	90440C	90589C
5.00 (127.00)	84.00 (2133.60)	–	90610C	–	–	–	89989C	–	–	90441C	–
5.00 (127.00)	96.00 (2438.40)	–	–	–	90608C	–	89990C	–	89298C	90442C	90591C
5.00 (127.00)	108.00 (2743.20)	–	90612C	–	–	–	90526C	–	928011C	90597C	–
5.00 (127.00)	120.00 (3048.00)	–	90613C	–	–	–	90614C	–	–	90604C	–
6.00 (152.40)	20.00 (508.00)	–	–	–	–	89147A	–	89157A	–	–	–
6.00 (152.40)	24.00 (609.60)	90904A	–	–	–	–	–	–	–	–	–
6.00 (152.40)	36.00 (914.40)	89219A	–	–	–	89223A	89223C	89228A	89228C	–	–
6.00 (152.40)	48.00 (1219.20)	–	–	–	–	89224A	89224C	89229A	–	–	–

Exhaust Accessories

Stack Pipes

Curved Stack Pipes and Tail Pipes

- Angle cut
- Bright, exceptional quality chrome or 16 gauge aluminized steel

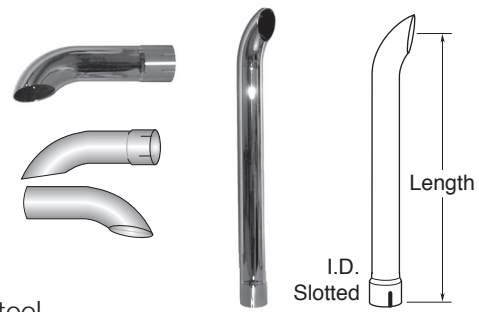

Type	Diameter in (mm)	Length in (mm)	I.D. - O.D.		O.D. - O.D.	
			Aluminized Part Number	Chrome Plated Part Number	Aluminized Part Number	Chrome Plated Part Number
Curved Stack Pipe	2.00 (50.80)	9.00 (228.60)	89140A	—	89150A	—
Curved Stack Pipe	2.25 (57.15)	10.00 (254.00)	89285A	—	—	—
Tail Pipe	2.50 (63.50)	11.00 (279.40)	89141A	—	89151A	—
Curved Stack Pipe	2.75 (69.85)	12.00 (304.80)	89142A	—	89152A	—
Tail Pipe	3.00 (76.20)	12.00 (304.80)	89143A	89143C	89153A	—
Curved Stack Pipe	3.00 (76.20)	24.00 (609.60)	—	—	89035A	89035C
Curved Stack Pipe	3.00 (76.20)	36.00 (914.40)	89050A	89050C	89036A	89036C
Curved Stack Pipe	3.00 (76.20)	48.00 (1219.20)	89051A	89051C	89037A	89037C
Curved Stack Pipe	3.00 (76.20)	60.00 (1524.00)	925051A	925051C	900088A	900088C
Tail Pipe	3.50 (88.90)	12.00 (304.80)	89144A	89144C	89154A	—
Curved Stack Pipe	3.50 (88.90)	24.00 (609.60)	89052A	89052C	89040A	—
Curved Stack Pipe	3.50 (88.90)	36.00 (914.40)	89053A	89053C	89041A	—
Curved Stack Pipe	3.50 (88.90)	48.00 (1219.20)	89054A	89054C	89042A	—
Curved Stack Pipe	3.50 (88.90)	60.00 (1524.00)	89225A	89225C	89221A	89221C
Tail Pipe	4.00 (101.60)	12.00 (304.80)	90909A	90909C	90913A	—
Tail Pipe	4.00 (101.60)	17.50 (444.50)	89145A	89145C	89155A	89155C
Curved Stack Pipe	4.00 (101.60)	24.00 (609.60)	89055A	89055C	89043A	89043C
Curved Stack Pipe	4.00 (101.60)	36.00 (914.40)	89056A	89056C	89044A	—
Curved Stack Pipe	4.00 (101.60)	48.00 (1219.20)	89057A	89057C	89045A	89045C
Curved Stack Pipe	4.00 (101.60)	60.00 (1524.00)	89226A	89226C	89222A	89222C
Tail Pipe	4.50 (114.30)	17.50 (444.50)	90563A	—	—	—
Tail Pipe	5.00 (127.00)	13.20 (335.28)	90910A	90910C	—	—
Tail Pipe	5.00 (127.00)	18.00 (457.20)	89146A	89146C	89156A	89156C
Curved Stack Pipe	5.00 (127.00)	24.00 (609.60)	89058A	89058C	89046A	89046C
Curved Stack Pipe	5.00 (127.00)	36.00 (914.40)	89059A	—	89047A	—
Curved Stack Pipe	5.00 (127.00)	48.00 (1219.20)	89060A	89060C	89048A	—
Curved Stack Pipe	5.00 (127.00)	60.00 (1524.00)	89227A	89227C	89049A	—
Tail Pipe	6.00 (152.40)	20.00 (508.00)	89147A	89147C	89157A	—
Curved Stack Pipe	6.00 (152.40)	36.00 (914.40)	89223A	89223C	89228A	89228C
Curved Stack Pipe	6.00 (152.40)	48.00 (1219.20)	89224A	89224C	89229A	—

Specifications subject to change without notice. See page 1-8 for cleaning chrome.
All parts listed are subject to lead time.

Exhaust Accessories

Stack Pipes

90° Curved Stack Pipes

- Bright, exceptional quality chrome or 16 gauge aluminized steel

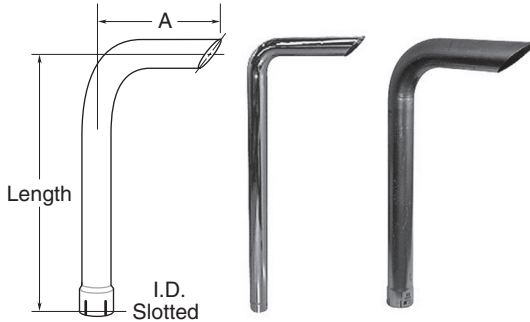

Diameter in (mm)	Length in (mm)	A Leg Length in (mm)	Aluminized Part Number	Chrome Part Number
3.00 (76.20)	48.00 (1219.20)	24.00 (609.60)	89051A	–
4.00 (101.60)	48.00 (1219.20)	24.00 (609.60)	90443A	–
4.00 (101.60)	60.00 (1524.00)	24.00 (609.60)	90444A	90444C

* One piece construction

Dump Truck Stacks

- Bright, exceptional quality chrome or 16 gauge aluminized steel

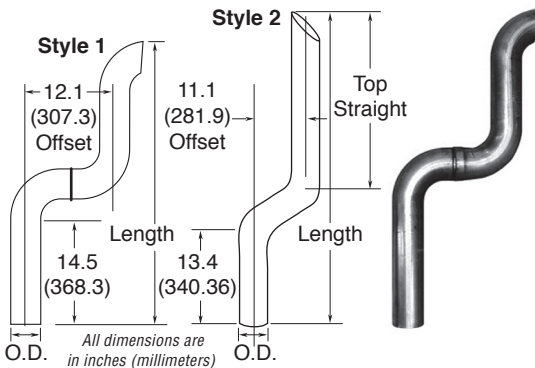

Diameter in (mm)	Style	Length in (mm)	Top Straight in (mm)	Aluminized Part Number	Chrome Part Number
4.00 (101.60)	2	51.00 (1295.40)	31.1 (789.9)	90451A	90451C
4.00 (101.60)	1	38.00 (965.20)	N/A	89899A	–
5.00 (127.00)	1	38.00 (965.20)	N/A	900091A	–
5.00 (127.00)	2	51.00 (1295.40)	29.2 (741.7)	90452A	90452C*

* One piece construction

Custom Length Stacks

- Painted black

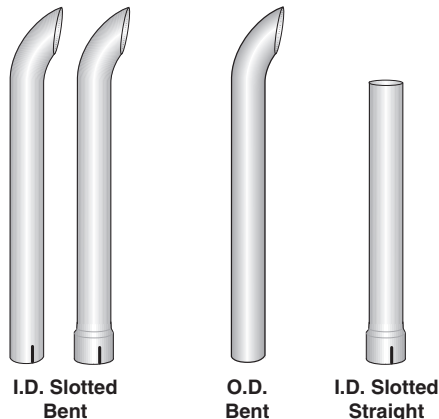

Diameter in (mm)	Length in (mm)	I.D. Slotted Part Number
2.00 (50.80)	28.75 (730.25)	Q42331
2.50 (63.50)	31.00 (787.40)	Q42097
2.50 (63.50)	37.50 (952.50)	Q42088
2.50 (63.50)	44.00 (1117.60)	Q25344
3.00 (76.20)	22.00 (558.80)	Q26688*
4.19 (106.43)	27.00 (685.80)	Q42089

* Straight stack

Exhaust Accessories

Stack Pipes

6" by 5" (152 mm by 127 mm) "Monster" Stacks

- Change the appearance of a factory system by replacing a standard 5" (127 mm) stack with a 6" (152 mm) stack. Obtain lower restriction and "dress up" your truck.
- Bright, exceptional quality chrome
- 6" (152 mm) tubing sized down to fit 5" (127 mm) system, no weld joints



Length in (mm)	Style	Chrome Part Number
36.00 (914.40)	1	90842C
48.00 (1219.20)	1	90568C
60.00 (1524.00)	1	90570C
72.00 (1828.80)	1	90571C
48.00 (1219.20)	2	900035C
96.00 (2438.40)	2	90576C
108.00 (2743.20)	2	90577C
120.00 (3048.00)	2	90578C
36.00 (914.40)	3	900092C
48.00 (1219.20)	3	900093C
60.00 (1524.00)	3	900094C
48.00 (1219.20)	4	924072C
60.00 (1524.00)	4	90905C
72.00 (1828.80)	4	90447C
84.00 (2133.60)	4	90448C
96.00 (2438.40)	4	90449C
108.00 (2743.20)	4	90450C
120.00 (3048.00)	4	90579C

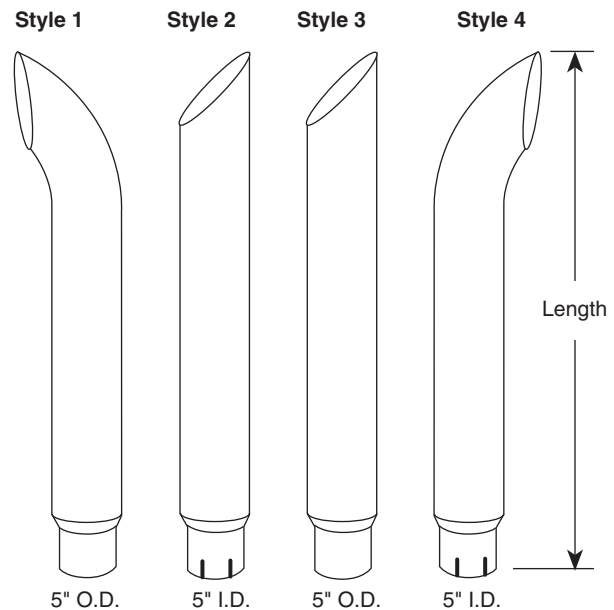

Specifications subject to change without notice. See page 1-8 for cleaning chrome.
All parts listed are subject to lead time.

Exhaust Accessories

Heat Guards

- Available in both aluminized and bright stainless steels with various degrees of wrap and hole patterns

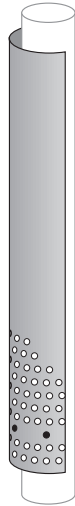

1/2 WRAP PIPE GUARD
(round hole pattern shown)

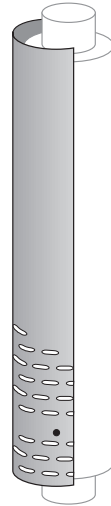

1/2 WRAP MUFFLER GUARD
(vertical slot pattern available horizontal slot pattern shown)

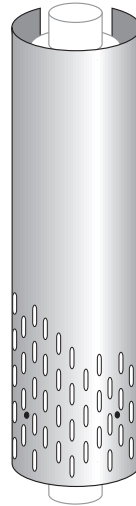

3/4 WRAP MUFFLER GUARD
(vertical slot pattern shown)



3/4 WRAP MUFFLER GUARD
(blank pattern shown)

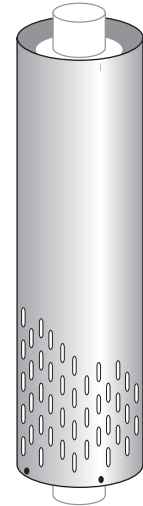

360° MUFFLER GUARD
(vertical slot pattern shown)

Description in (mm)	Guard Wrap	Length in (mm)	Material	Part Number			
				.75 Dia. Hole Pattern	Horizontal Slot Pattern	Vertical Slot Pattern	Blank Pattern
4.00 - 5.00 (101.60 - 127.00) Pipe	1/2	48.00 (1219.20)	Stainless	89744C	—	89744F	—
6.00 (152.4) Pipe	1/2	48.00 (1219.20)	Stainless	90856C	—	90976C	—
8.50 - 10.50 (215.90 - 266.70) Muffler	1/2	48.00 (1219.20)	Aluminized	89748A	—	—	—
8.50 - 10.50 (215.90 - 266.70) Muffler	1/2	48.00 (1219.20)	Stainless	—	89996C	89745C	—
8.50 - 10.13 (215.90 - 257.30) Muffler	3/4	48.00 (1219.20)	Stainless	89749C	89995C	89774C	—
8.50 - 10.13 (215.90 - 257.30) Muffler	3/4	51.00 (1295.40)	Stainless	90555C	90556C	—	90461C
9.00 - 10.50 (228.60 - 266.70) Muffler	360°	49.00 (1244.60)	Stainless	—	—	90901C	—

Specifications subject to change without notice. See page 1-8 for cleaning chrome. All parts listed are subject to lead time.

Exhaust Diffusers

Exhaust Accessories

Exhaust Diffusers

Slotted Stack Exhaust Diffusers

- 4.0" (101.60 mm) and 5.0" (127.00 mm) inlet sizes
- Stainless steel
- Short diffuser for compact configuration
- Long diffuser for optimum temperature reduction
- Vertical or horizontal installation



New!

Size in (mm)	Description	Part Number
4.00 (101.60)	Slotted Stack Diffuser – Short	A030F890
5.00 (127.00)	Slotted Stack Diffuser – Short	A030F892
4.00 (101.60)	Slotted Stack Diffuser – Long	A030F891
5.00 (127.00)	Slotted Stack Diffuser – Long	A030F893

Slotted Stack Exhaust Diffuser U-Bolt Clamp

Size in (mm)	Description	Part Number
4.00 (101.60) and 5.00 (127.00)	Diffuser U-Bolt Clamp	Q629839

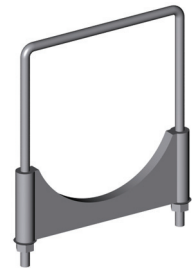

New!

Note: Purchaser is responsible for all application, endurance and verification testing prior to production release.

Specifications subject to change without notice. See page 1-8 for cleaning chrome.
All parts listed are subject to lead time.

Exhaust Accessories

Brackets

Stack Support Brackets

- Use with stacks for vertical support

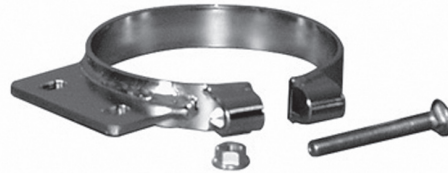
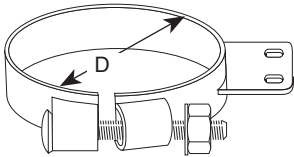

D Diameter in (mm)	Chrome Part Number
5.00 (127.00)	900022C
6.00 (152.40)	90598C

Universal Mounting Bracket

- For 4" to 5" (102 to 127 mm) U-Bolt Clamps

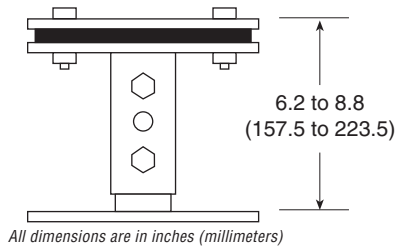

Part Number

89518K

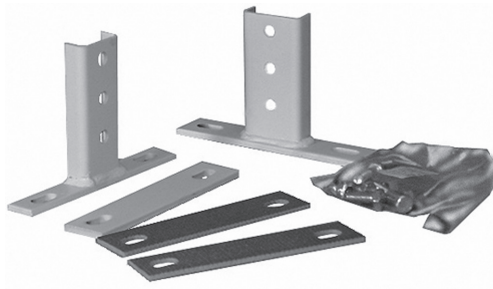

360° Guard Bracket Kit

- Can be modified for off-center tubes
- Not visible above shield
- Includes two complete brackets and all hardware required to mount shield
- Fits 5" (127 mm) O.D. tube

Part Number

90900K



Exhaust Accessories

Hangers

Universal Swivel Hangers

- Heavy reinforced rubber pad
- Swivel design permits 360° mounting
- One piece construction installs in seconds
- New closed end allows easy connection and assembly of loose system components

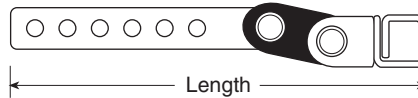

Length in (mm)	Part Number
9.60 (243.80)	89519K
13.30 (337.82)	90863K
17.30 (439.42)	90843K

Universal Pipe Hangers

- Clamp and hanger strap are made of heavy gauge steel to hold tail pipe and exhaust pipe

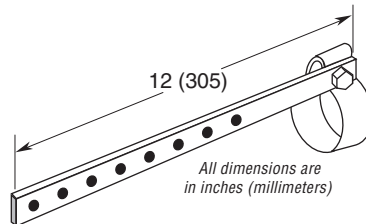

Fits Pipe Diameter in (mm)	Part Number
3.00 (76.20)	90076A
4.00 (101.60)	90079A
5.00 (127.00)	90080A

Universal Muffler Hangers

- Heavy duty muffler body clamp and hanger strap
- The strap can be bent and twisted to fit the installation. Use for horizontal or vertical mount. Use two for maximum rigidity.

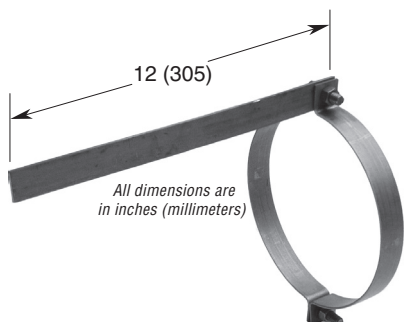

Body Diameter in (mm)	Part Number
7.00 (177.80)	89535K
8.00 (203.20)	89536K
8.25 x 11.50 (209.55 x 292.10)	89537K
8.50 (215.90)	89538K
9.00 (228.60)	89539K
10.00 (254.00)	89540K
10.00 x 15.00 (254.00 x 381.00)	89551K
11.00 (279.40)	900005A

Specifications subject to change without notice. See page 1-8 for cleaning chrome.
All parts listed are subject to lead time.

Exhaust Accessories

Miscellaneous Accessories

Clamp Kits

- Two chrome clamps per kit
- Stainless mounting hardware supplied with each kit

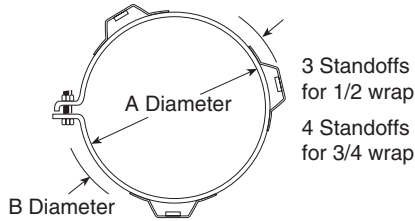

A in (mm)	B in (mm)	Part Number	
		1/2 Wrap	3/4 Wrap
5.00 (127.00)	6.75 (171.45)	89771K	—
6.00 (152.40)	7.75 (196.85)	90857K	—
8.50 (215.90)	10.25 (260.35)	89761K	—
9.00 (228.60)	10.75 (273.05)	89762K	89766K
10.12 (257.05)	11.85 (300.99)	89763K	89767K

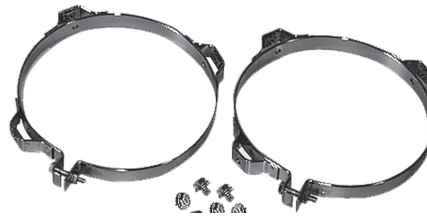

Universal Grab Hanger

- Chrome plated

Part Number

89775K

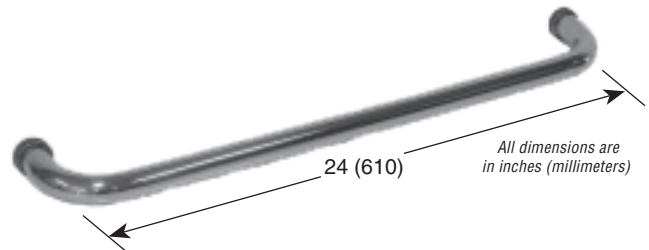

Rain Caps

- Single bolt mounting
- Heavy duty welded assembly



Silent Rain Caps

- Nylon stop for quiet operation



Exhaust Stack Outside Diameter in (mm)	Counter Balance Type Rain Cap		Silent Rain Cap
	Zinc Plated Part Number	Chrome Part Number	Zinc Plated Part Number
1.75 (273.05)	89417A	—	—
2.00 (50.80)	89420A	—	—
2.25 (57.15)	89422A	—	—
2.50 (63.50)	89425A	—	—
2.75 (69.85)	89427A	—	—
3.00 (76.20)	—	—	89430E
3.50 (88.90)	89435A	—	89435E
4.00 (101.60)	89440A	89440C	89440E
4.50 (114.30)	89445A	—	—
5.00 (127.00)	89450A	89450C	89450E
6.00 (152.40)	89460A	89460C	—

Exhaust Accessories

Miscellaneous Accessories

Exhaust Elbow/Pipe Shield

- Used on 3" (76 mm) through 5" (127 mm) O.D. exhaust tubes
- Protects hoses and wiring from high temperatures
- Installs in seconds anywhere on elbow or straight section using standard hose clamps (not supplied)

Part Number

90587K

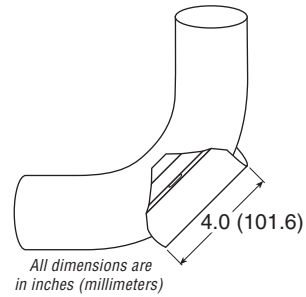

Chrome Light Deflectors

- Bright, exceptional quality chrome

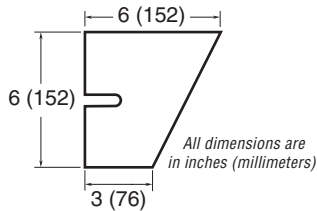

Part Number

90289C

90290C

Chrome Part Side

LH

RH

Mounting Bands

- Mild steel or black paint finish

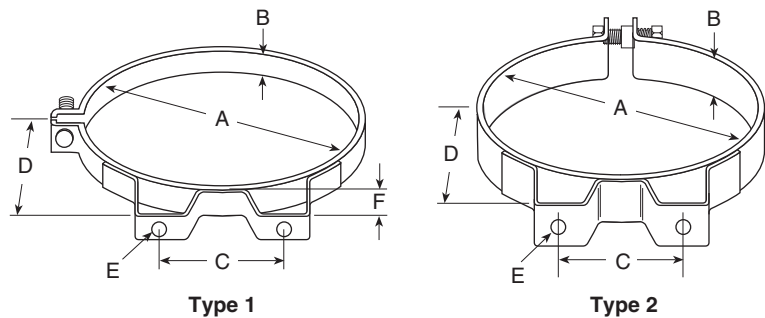

A in (mm)	B in (mm)	C in (mm)	D in (mm)	E in (mm)	F in (mm)	Type	Material*	Part Number
7.17 (182.12)	0.88 (22.35)	3.50 (88.90)	4.09 (103.89)	0.344 (8.738)	0.50 (12.70)	1	Mild Steel**	Q186516
7.89 (200.41)	0.88 (22.35)	4.25 (107.95)	4.45 (113.03)	0.344 (8.738)	0.50 (12.70)	1	Mild Steel**	Q186201
10.30 (261.62)	1.25 (31.75)	5.00 (127.00)	6.03 (153.16)	0.406 (10.312)	0.88 (22.35)	1	Mild Steel**	Q186286

* Mild steel bands are finished with gray primer unless otherwise noted

** Finished with black paint

Specifications subject to change without notice. See page 1-8 for cleaning chrome.

All parts listed are subject to lead time.



Section 3: Standard Line Mufflers



Table of Contents

Section 3:	
Standard Line Mufflers	3-1
Type 1	3-3
End In/Opposite End Out Both On Center	3-3
Type 2	3-8
End In/Opposite End Out Both Offset	3-8
Type 2A.....	3-12
Dual End In/ Opposite End Out.....	3-12
Type 3.....	3-13
End In/End Out – Same End.....	3-13
Type 4.....	3-14
End In/Opposite End Out – Outlet Offset.....	3-14
Type 5.....	3-15
Side In/End Out	3-15
Type 7	3-18
End In/Side Out	3-18
Type 8.....	3-21
Side In / Side Out	3-21
Installation Notes.....	3-22
Engine Data	3-22



Standard Line Mufflers

Type 1

End In/Opposite End Out

Both On Center

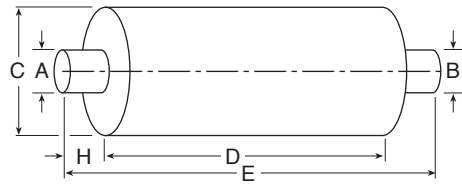

Part Number	A Inlet I.D. in (mm)	B Outlet I.D. in (mm)	C Body Size in (mm)	D Body Length in (mm)	E Overall Length in (mm)	F Inlet Offset in (mm)	G Outlet Offset in (mm)	H Inlet Length in (mm)	Inlet Clock Position	Outlet Clock Position	Max. Flow Rate			Notes*
											@ 3" Hg	@ 2" Hg	@ 1" Hg	
48210U	1.0 (25.4) NPT	1.4 (35.6) O.D.	3.2 (81.3)	8.0 (203.2)	11.9 (302.3)	-	-	2.0 (50.8)	-	-	170	140	-	A
16487T	1.3 (33.0)	1.4 (35.6) O.D.	3.2 (81.3)	9.6 (243.8)	22.2 (563.9)	0	0	2.5 (63.5)	0	0	150	120	-	A
49025N	1.5 (38.1)	1.5 (38.1)	1.5 (38.1)	1.8 (45.7)	3.2 (81.3)	-	-	-	-	-	-	-	-	-
48215U	1.5 (38.1) NPT	2.0 (50.8) O.D.	4.6 (116.8)	10.0 (254.0)	14.7 (373.4)	-	-	2.2 (55.9)	-	-	340	275	-	A
05388T	1.8 (45.7)	1.7 (43.2)	3.3 (83.8)	19.5 (495.3)	31.3 (795.0)	-	-	11.8 (299.7)	-	-	240	200	-	A, C
09166T	1.9 (48.3)	2.0 (50.8) O.D.	4.6 (116.8)	15.6 (396.2)	28.4 (721.4)	0	0	2.2 (55.9)	0	0	305	245	-	A
10811T	1.9 (48.3)	2.0 (50.8) O.D.	5.6 (142.2)	13.1 (332.7)	28.0 (711.2)	0	0	2.7 (68.6)	0	0	395	320	-	A
86177M	2.0 (50.8)	2.1 (54.0) O.D.	4.2 (106.7)	12.7 (322.6)	17.1 (434.3)	0	0	2.0 (50.8)	0	0	400	340	-	A
14222T	2.1 (53.3)	2.3 (58.4) O.D.	4.6 x 8.4 (116.8 x 213.4)	20.0 (508.0)	35.0 (889.0)	-	-	3.0 (76.2)	-	-	420	340	-	A, G
16730T	2.1 (53.3) Flange	2.5 (63.5) O.D.	6.6 (167.6)	5.1 (129.5)	10.5 (266.7)	0	0	2.5 (63.5)	0	0	335	275	-	A
20332A	2.2 (55.9) Flange	2.1 (54.0) O.D.	9.6 (243.8)	8.5 (215.9)	17.4 (442.0)	0	0	3.0 (76.2)	0	0	535	440	-	A
14245T	2.4 (61.0)	2.5 (63.5) O.D.	5.6 (142.2)	16.8 (426.7)	32.0 (812.8)	0	0	2.7 (68.6)	0	0	540	440	-	A
22706T	2.5 (63.5)	2.5 (63.5)	4.3 (109.2)	14.0 (355.6)	18.5 (469.9)	0	0	2.25 (57.15)	0	0	575	500	-	A
86186M	2.5 (63.5)	2.5 (63.5)	6.1 (154.9)	21.0 (533.4)	30.0 (762.0)	0	0	4.5 (114.3)	0	0	860	715	-	A
11396T	2.5 (63.5)	2.0 (50.8) O.D.	4.6 (116.8)	17.0 (431.8)	30.0 (762.0)	-	-	8.0 (203.2)	-	-	365	300	-	A

Standard Line Mufflers

Type 1

End In/Opposite End Out

Both On Center

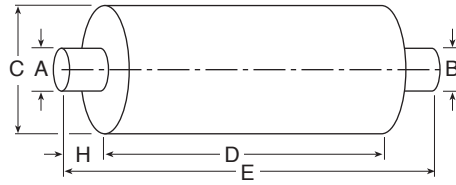

Part Number	A Inlet I.D. in (mm)	B Outlet I.D. in (mm)	C Body Size in (mm)	D Body Length in (mm)	E Overall Length in (mm)	F Inlet Offset in (mm)	G Outlet Offset in (mm)	H Inlet Length in (mm)	Inlet Clock Position	Outlet Clock Position	Max. Flow Rate			Notes*
											@ 3" Hg	@ 2" Hg	@ 1" Hg	
20680T	2.5 (63.5)	2.5 (63.5) O.D.	4.6 x 8.4 (116.8 x 213.4)	18.0 (457.2)	24.0 (609.6)	-	-	2.5 (63.5)	-	-	460	380	-	A
86178M	2.5 (63.5)	2.6 (66.0) O.D.	4.6 (116.8)	15.7 (398.8)	27.6 (701.0)	0	0	8.0 (203.2)	0	0	560	470	-	A
86172M	2.5 (63.5) NPT	2.5 (63.5) NPT	6.1 (154.9)	14.1 (358.1)	18.1 (459.7)	-	-	2.0 (50.8)	-	-	490	410	-	-
11650T	2.9 (73.7)	3.0 (76.2) O.D.	6.1 x 10.1 (154.9 x 256.5)	26.0 (660.4)	32.5 (825.5)	0	0	2.6 (66.0)	0	0	930	760	-	A
11651T	2.9 (73.7)	3.0 (76.2) O.D.	6.1 x 10.1 (154.9 x 256.5)	26.0 (660.4)	43.1 (1094.7)	0	0	13.2 (335.3)	0	0	865	710	-	A
10156T	2.9 (73.7)	3.1 (78.7) O.D.	5.6 (142.2)	20.3 (515.6)	32.5 (825.5)	0	0	2.6 (66.0)	0	0	675	550	-	A
86187M	3.0 (76.2)	3.0 (76.2)	6.1 (154.9)	21.0 (533.4)	30.0 (762.0)	0	0	4.5 (114.3)	0	0	1100	920	-	A
20153T	3.0 (76.2)	3.1 (78.7) O.D.	8.1 (205.7)	12.2 (309.9)	17.0 (431.8)	0	0	1.4 (35.6)	0	0	750	600	-	A
86173M	3.0 (76.2) NPT	3.0 (76.2) NPT	7.1 (180.3)	15.0 (381.0)	19.8 (502.9)	0	0	2.4 (61.0)	0	0	1000	835	-	-
21322N	3.09 (78.49) Flared	2.125 (53.98)	4.25 (107.95)	12.7 (322.6)	17.1 (434.3)	-	-	2.0 (50.8)	-	-	458	374	-	-
11731T	3.1 (78.7)	3.0 (76.2) O.D.	6.1 x 10.1 (154.9 x 256.5)	26.0 (660.4)	50.9 (1292.9)	0	0	21.0 (533.4)	0	0	905	740	-	A
86690M	3.18 (80.77)	3.18 (80.77)	10.1 (256.5)	23.5 (596.9)	28.6 (726.4)	-	-	2.5 (63.5)	-	-	1000	815	-	-
86113M	3.5 (88.9)	3.5 (88.9)	9.0 (228.6)	44.5 (1130.3)	51.0 (1295.4)	0	0	3.0 (76.2)	0	0	1200	1000	-	A
86188M	3.5 (88.9)	3.5 (88.9)	7.1 (180.3)	30.0 (762.0)	38.0 (965.2)	0	0	3.7 (94.0)	0	0	1450	1200	-	A
86744M	3.5 (88.9)	3.5 (88.9)	11.1 (281.9)	22.75 (577.85)	28.75 (730.25)	-	-	3.3 (82.6)	-	-	850	695	-	-

Standard Line Mufflers

Type 1

End In/Opposite End Out

Both On Center

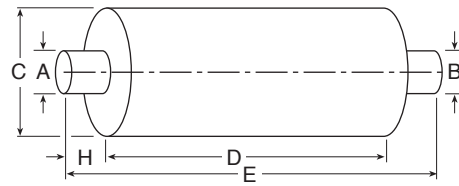

Part Number	A Inlet I.D. in (mm)	B Outlet I.D. in (mm)	C Body Size in (mm)	D Body Length in (mm)	E Overall Length in (mm)	F Inlet Offset in (mm)	G Outlet Offset in (mm)	H Inlet Length in (mm)	Inlet Clock Position	Outlet Clock Position	Max. Flow Rate			Notes*
											@ 3" Hg	@ 2" Hg	@ 1" Hg	
11026T	3.5 (88.9)	3.6 (91.4) O.D.	5.6 (142.2)	27.1 (688.3)	42.2 (1071.9)	0	0	3.9 (99.1)	0	0	1335	1090	–	A
17704T	3.7 (94.0)	3.5 (88.9) O.D.	6.1 x 10.1 (154.9 x 256.5)	25.0 (635.0)	43.6 (1107.4)	0	0	10.6 (269.2)	0	0	1455	1190	–	A
200445N	4.0 (101.6)	4.0 (101.6)	9.0 (228.6)	15.5 (393.7)	34.7 (881.4)	–	–	–	–	–	1950	1592	–	J
86108M	4.0 (101.6)	4.0 (101.6)	9.0 (228.6)	44.5 (1130.3)	51.0 (1295.4)	0	0	3.0 (76.2)	0	0	1600	1350	–	A
86127M	4.0 (101.6)	4.0 (101.6)	8.5 (215.9)	34.4 (873.8)	40.0 (1016.0)	0	0	2.5 (63.5)	0	0	2000	1670	–	A
86131M	4.0 (101.6)	4.0 (101.6)	9.0 (228.6)	44.5 (1130.3)	51.0 (1295.4)	0	0	3.0 (76.2)	0	0	2000	1670	–	A
86189M	4.0 (101.6)	4.0 (101.6)	7.1 (180.3)	28.0 (711.2)	36.0 (914.4)	0	0	3.7 (94.0)	0	0	2100	1750	–	A
86215M	4.0 (101.6)	4.0 (101.6)	10.1 (256.5)	45.0 (1143.0)	51.0 (1295.4)	0	0	2.5 (63.5)	0	0	1400	1150	–	A, B
86544M	4.0 (101.6)	4.0 (101.6)	10.1 (256.5)	44.5 (1130.3)	51.0 (1295.4)	0	0	3.0 (76.2)	0	0	1600	1350	–	A
86560M	4.0 (101.6)	4.0 (101.6)	9.0 (228.6)	20.0 (508.0)	27.0 (685.8)	0	0	3.5 (88.9)	0	0	2000	1670	–	A
86561M	4.0 (101.6)	4.0 (101.6)	9.0 (228.6)	28.1 (713.7)	34.6 (878.8)	0	0	3.2 (81.3)	0	0	1875	1580	–	A
86630M	4.0 (101.6)	4.0 (101.6)	9.0 (228.6)	44.5 (1130.3)	51.0 (1295.4)	–	–	3.0 (76.2)	–	–	1600	1350	–	A, HD 86108M
86713M	4.0 (101.6)	4.0 (101.6)	9.0 (228.6)	44.5 (1130.3)	51.0 (1295.4)	0	0	3.0 (76.2)	0	0	1750	1450	–	A, EM
86514M	4.0 (101.6)	5.0 (127.0)	9.0 (228.6)	44.5 (1130.3)	51.0 (1295.4)	0	0	3.0 (76.2)	0	0	1650	1375	–	A
86535M	4.0 (101.6)	5.0 (127.0)	10.1 (256.5)	44.5 (1130.3)	51.0 (1295.4)	0	0	3.0 (76.2)	0	0	2400	2000	–	A
86547M	4.0 (101.6)	5.0 (127.0)	10.1 (256.5)	44.5 (1130.3)	51.0 (1295.4)	0	0	3.0 (76.2)	0	0	1700	1430	–	A
86740M	4.0 (101.6)	5.0 (127.0)	9.0 (228.6)	44.5 (1130.3)	51.0 (1295.4)	0	0	3.0 (76.2)	0	0	1900	1500	–	A, EM

Standard Line Mufflers

Type 1

End In/Opposite End Out

Both On Center

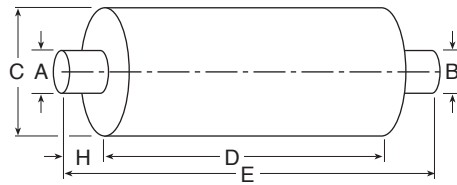

Part Number	A Inlet I.D. in (mm)	B Outlet I.D. in (mm)	C Body Size in (mm)	D Body Length in (mm)	E Overall Length in (mm)	F Inlet Offset in (mm)	G Outlet Offset in (mm)	H Inlet Length in (mm)	Inlet Clock Position	Outlet Clock Position	Max. Flow Rate			Notes*
											@ 3" Hg	@ 2" Hg	@ 1" Hg	
86773M	4.0 (101.6)	5.0 (127.0)	10.1 (256.5)	44.5 (1130.3)	51.0 (1295.4)	0	0	3.0 (76.2)	0	0	1880	1535	–	A, EM
04849T	4.0 (101.6)	4.0 (101.6) O.D.	8.5 (215.9)	12.4 (315.0)	19.1 (485.1)	0	0	2.0 (50.8)	0	0	3040	2485	–	A
20619T	4.0 (101.6)	4.12 (104.65) O.D.	7.0 (177.8)	19.0 (482.6)	25.5 (647.7)	–	–	–	–	–	1540	1230	–	A
86175M	4.0 (101.6) NPT	4.0 (101.6) NPT	8.5 (215.9)	20.0 (508.0)	26.0 (660.4)	0	0	3.00 (76.20)	0	0	1850	1550	–	–
19094N	4.0 (101.6) NPT	4.0 (101.6) NPT	10.0 (254.0)	21.5 (546.1)	29.5 (749.3)	–	–	4.00 (101.60)	–	–	1300	1061	–	G
18901T	4.3 (109.2) Flared	3.6 (91.4) O.D.	4.6 x 8.4 (116.8 x 213.4)	33.0 (838.2)	38.0 (965.2)	–	–	0.80 (20.32)	–	–	1305	1070	–	A
21317N	4.31 (109.47) Flared	3.5 (88.9)	7.12 (180.85)	30.0 (762.0)	38.0 (965.2)	–	–	3.70 (93.98)	–	–	1637	1337	–	–
20154T	4.4 (111.8)	4.4 (111.8)	8.0 x 10.0 (203.2 x 254.0)	17.5 (444.5)	26.75 (679.45)	–	–	–	–	–	900	735	–	–
20620T	4.4 (111.8)	4.5 (114.3) O.D.	9.0 (228.6)	17.8 (452.1)	26.8 (680.7)	0	0	4.80 (121.92)	0	0	1705	1400	–	A
200238N	5.0 (127.0)	5.0 (127.0)	9.0 (228.6)	20.0 (508.0)	26.5 (673.1)	–	–	3.00 (76.20)	–	–	1868	1525	–	–
200555N	5.0 (127.0)	5.0 (127.0)	9.0 (228.6)	22.0 (558.8)	48.5 (1231.9)	–	–	3.00 (76.20)	–	–	3121	2548	–	J
86102M	5.0 (127.0)	5.0 (127.0)	9.0 (228.6)	44.5 (1130.3)	51.0 (1295.4)	0	0	3.00 (76.20)	0	0	2160	1800	–	A
86130M	5.0 (127.0)	5.0 (127.0)	10.1 (256.5)	44.5 (1130.3)	51.0 (1295.4)	0	0	3.00 (76.20)	0	0	2300	1920	–	A
86132M	5.0 (127.0)	5.0 (127.0)	9.0 (228.6)	44.5 (1130.3)	51.0 (1295.4)	0	0	3.00 (76.20)	0	0	3600	3000	–	A

Standard Line Mufflers

Type 1

End In/Opposite End Out

Both On Center

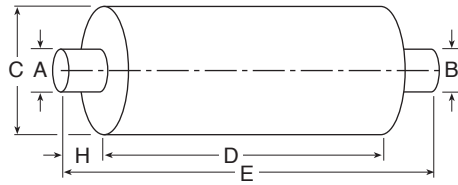

Part Number	A Inlet I.D. in (mm)	B Outlet I.D. in (mm)	C Body Size in (mm)	D Body Length in (mm)	E Overall Length in (mm)	F Inlet Offset in (mm)	G Outlet Offset in (mm)	H Inlet Length in (mm)	Inlet Clock Position	Outlet Clock Position	Max. Flow Rate			Notes*
											@ 3" Hg	@ 2" Hg	@ 1" Hg	
86195M	5.0 (127.0)	5.0 (127.0)	10.1 (256.5)	44.5 (1130.3)	51.0 (1295.4)	0	0	3.00 (76.20)	0	0	2800	2330	–	A
86196M	5.0 (127.0)	5.0 (127.0)	10.1 (256.5)	44.5 (1130.3)	51.0 (1295.4)	0	0	3.00 (76.20)	0	0	1700	1400	–	A
86531M	5.0 (127.0)	5.0 (127.0)	10.1 (256.5)	44.5 (1130.3)	51.0 (1295.4)	0	0	3.00 (76.20)	0	0	2800	2330	–	A
86533M	5.0 (127.0)	5.0 (127.0)	10.1 (256.5)	44.5 (1130.3)	51.0 (1295.4)	0	0	3.00 (76.20)	0	0	2650	2210	–	A
86624M	5.0 (127.0)	5.0 (127.0)	9.0 (228.6)	33.5 (850.9)	40.0 (1016.0)	0	0	3.00 (76.20)	0	0	2160	1800	–	A
86626M	5.0 (127.0)	5.0 (127.0)	10.1 (256.5)	60.0 (1524.0)	66.5 (1689.1)	0	0	3.00 (76.20)	0	0	3000	2550	–	A, B
86682M	5.0 (127.0)	5.0 (127.0)	10.1 (256.5)	44.5 (1130.3)	51.0 (1295.4)	0	0	3.00 (76.20)	0	0	2850	2400	–	A, EM
86739M	5.0 (127.0)	5.0 (127.0)	9.0 (228.6)	44.5 (1130.3)	51.0 (1295.4)	0	0	3.00 (76.20)	0	0	2850	2400	–	A, EM
86772M	5.0 (127.0)	5.0 (127.0)	10.1 (256.5)	33.5 (850.9)	40.0 (1016.0)	0	0	3.00 (76.20)	0	0	2300	1920	–	A
86776M	5.0 (127.0)	5.0 (127.0)	10.1 (256.5)	44.5 (1130.3)	51.0 (1295.4)	0	0	3.00 (76.20)	0	0	2300	1880	–	A
86788M	5.0 (127.0)	5.0 (127.0)	10.09 (256.29)	44.5 (1130.3)	53.0 (1346.2)	—	—	3.00 (76.20)	–	–	2651	2164	–	–
86656M	5.0 (127.0)	6.0 (152.4)	10.1 (256.5)	44.5 (1130.3)	51.0 (1295.4)	0	0	3.00 (76.20)	0	0	3400	2775	–	A
86610M	6.0 (152.4)	6.0 (152.4)	11.1 (281.9)	44.5 (1130.3)	51.0 (1295.4)	0	0	3.00 (76.20)	0	0	3700	3020	–	A

Standard Line Mufflers

Type 2

End In/Opposite End Out

Both Offset

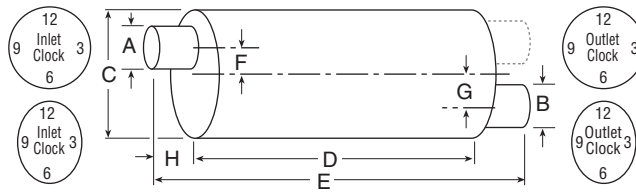

Part Number	A Inlet I.D. in (mm)	B Outlet I.D. in (mm)	C Body Size in (mm)	D Body Length in (mm)	E Overall Length in (mm)	F Inlet Offset in (mm)	G Outlet Offset in (mm)	H Inlet Length in (mm)	Inlet Clock Position	Outlet Clock Position	Max. Flow Rate			Notes*
											@ 3" Hg	@ 2" Hg	@ 1" Hg	
86136M	2.0 (50.8)	2.0 (50.8)	6.1 (154.9)	24.0 (609.6)	30.0 (762.0)	1.4 (35.6)	1.4 (35.6)	3.0 (76.2)	12	6	500	420	–	–
86137M	2.5 (63.5)	2.5 (63.5)	6.6 (167.6)	28.0 (711.2)	35.0 (889.0)	1.4 (35.6)	1.4 (35.6)	3.5 (88.9)	12	6	800	670	–	–
86518M	2.5 (63.5)	2.5 (63.5)	6.1 (154.9)	25.8 (655.3)	33.0 (838.2)	1.5 (38.1)	1.25 (31.75)	3.6 (91.4)	12	6	540	450	–	–
86675M	2.5 (63.5)	2.5 (63.5)	4.1 x 9.0 (104.1 x 228.6)	28.0 (711.2)	36.4 (924.6)	0.2 (5.1)	2.8 (71.1)	4.2 (106.7)	6	12	625	510	–	A
86164M	2.75 (69.85)	2.75 (69.85) O.D.	7.1 (180.3)	35.0 (889.0)	40.0 (1016.0)	1.5 (38.1)	1.5 (38.1)	2.5 (63.5)	12	6	950	800	–	–
14663T	2.8 (71.1)	2.8 (71.1) O.D.	6.1 x 10.1 (154.9 x 256.5)	32.0 (812.8)	45.5 (1155.7)	2.9 (73.7)	2.9 (73.7)	5.0 (127.0)	–	–	735	600	–	A
86119M	3.0 (76.2)	3.0 (76.2)	8.5 (215.9)	27.8 (706.1)	33.0 (838.2)	2.0 (50.8)	2.0 (50.8)	2.2 (55.9)	12	6	1000	835	–	A
86139M	3.0 (76.2)	3.0 (76.2)	8.5 (215.9)	31.2 (792.5)	36.2 (919.5)	2.0 (50.8)	2.0 (50.8)	2.5 (63.5)	12	6	1150	960	–	–
86159M	3.0 (76.2)	3.0 (76.2)	8.3 x 11.5 (210.8 x 292.1)	26.0 (660.4)	34.0 (863.6)	2.5 (63.5)	2.5 (63.5)	4.0 (101.6)	12	6	1220	1020	–	A
86521M	3.0 (76.2)	3.0 (76.2)	8.5 (215.9)	31.2 (792.5)	36.2 (919.5)	2.0 (50.8)	2.0 (50.8)	2.5 (63.5)	12	6	1300	1000	–	HD
86106M	3.5 (88.9)	3.5 (88.9)	8.3 x 11.5 (210.8 x 292.1)	26.0 (660.4)	33.0 (838.2)	3.0 (76.2)	3.0 (76.2)	4.0 (101.6)	12	6	1050	880	–	A
86206M	3.5 (88.9)	3.5 (88.9)	8.4 x 11.6 (213.4 x 294.6)	26.0 (660.4)	32.0 (812.8)	3.0 (76.2)	3.0 (76.2)	3.0 (76.2)	12	6	1500	1250	–	B
86512M	3.5 (88.9)	4.0 (101.6)	8.3 x 11.5 (210.8 x 292.1)	28.0 (711.2)	32.3 (820.4)	2.5 (63.5)	2.5 (63.5)	2.1 (53.3)	12	6	1450	1210	–	–

Standard Line Mufflers

Type 2

End In/Opposite End Out

Both Offset

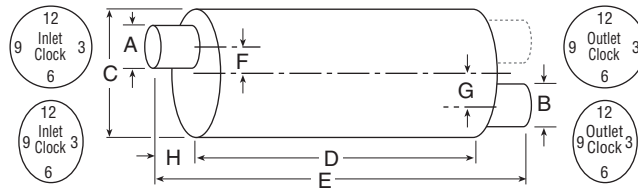

Part Number	A Inlet I.D. in (mm)	B Outlet I.D. in (mm)	C Body Size in (mm)	D Body Length in (mm)	E Overall Length in (mm)	F Inlet Offset in (mm)	G Outlet Offset in (mm)	H Inlet Length in (mm)	Inlet Clock Position	Outlet Clock Position	Max. Flow Rate			Notes*
											@ 3" Hg	@ 2" Hg	@ 1" Hg	
86536M	3.5 (88.9)	4.0 (101.6)	8.3 x 11.5 (210.8 x 292.1)	32.0 (812.8)	36.3 (922.0)	2.5 (63.5)	2.5 (63.5)	2.1 (53.3)	12	6	1300	1080	–	–
86631M	3.5 (88.9)	4.0 (101.6)	8.3 x 11.5 (210.8 x 292.1)	32.0 (812.8)	36.3 (922.0)	2.5 (63.5)	2.5 (63.5)	2.1 (53.3)	12	6	1050	880	–	HD 86536
86669M	3.5 (88.9)	4.0 (101.6)	8.3 x 11.5 (210.8 x 292.1)	28.0 (711.2)	32.3 (820.4)	2.5 (63.5)	2.5 (63.5)	2.1 (53.3)	12	6	1450	1210	–	HD 86512
22150T	3.5 (88.9)	4.1 (104.1) O.D.	6.1 x 10.1 (154.9 x 256.5)	18.8 (477.5)	28.1 (713.7)	2.4 (61.0)	2.4 (61.0)	3.5 (88.9)	12	6	1110	910	–	A, C, I
86213M	4.0 (101.6)	3.5 (88.9)	8.4 x 11.6 (213.4 x 294.6)	27.0 (685.8)	32.2 (817.9)	2.5 (63.5)	2.5 (63.5)	2.6 (66.0)	12	6	1500	1250	–	B
86118M	4.0 (101.6)	4.0 (101.6)	10.1 (256.5)	36.0 (914.4)	43.0 (1092.2)	2.5 (63.5)	2.5 (63.5)	3.0 (76.2)	12	6	1600	1350	–	A
86125M	4.0 (101.6)	4.0 (101.6)	10.0 x 15.0 (254.0 x 381.0)	26.0 (660.4)	33.0 (838.2)	4.2 (106.7)	4.2 (106.7)	3.0 (76.2)	12	6	1750	1460	–	A
86153M	4.0 (101.6)	4.0 (101.6)	8.3 x 11.5 (210.8 x 292.1)	27.0 (685.8)	33.2 (843.3)	2.5 (63.5)	2.5 (63.5)	3.1 (78.7)	12	6	1832	1496	–	–
86168M	4.0 (101.6)	4.0 (101.6)	10.1 (256.5)	27.8 (706.1)	33.5 (850.9)	2.5 (63.5)	2.5 (63.5)	3.0 (76.2)	12	6	1650	1375	–	A
86500M	4.0 (101.6)	4.0 (101.6)	11.1 (281.9)	30.0 (762.0)	36.2 (919.5)	2.5 (63.5)	2.5 (63.5)	3.1 (78.7)	12	6	1700	1420	–	B
86502M	4.0 (101.6)	4.0 (101.6)	11.1 (281.9)	36.0 (914.4)	41.2 (1046.5)	2.5 (63.5)	2.5 (63.5)	2.6 (66.0)	12	6	1580	1320	–	B
86505M	4.0 (101.6)	4.0 (101.6)	8.3 x 11.5 (210.8 x 292.1)	32.0 (812.8)	37.2 (944.9)	2.5 (63.5)	2.5 (63.5)	2.6 (66.0)	12	6	1500	1250	–	–
86529M	4.0 (101.6)	4.0 (101.6)	11.1 (281.9)	36.0 (914.4)	42.2 (1071.9)	2.5 (63.5)	2.5 (63.5)	3.1 (78.7)	12	6	1550	1300	–	–

Standard Line Mufflers

Type 2

End In/Opposite End Out

Both Offset

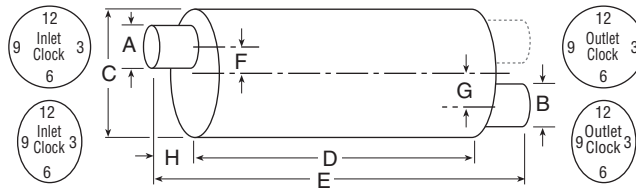

Part Number	A Inlet I.D. in (mm)	B Outlet I.D. in (mm)	C Body Size in (mm)	D Body Length in (mm)	E Overall Length in (mm)	F Inlet Offset in (mm)	G Outlet Offset in (mm)	H Inlet Length in (mm)	Inlet Clock Position	Outlet Clock Position	Max. Flow Rate			Notes*
											@ 3" Hg	@ 2" Hg	@ 1" Hg	
86541M	4.0 (101.6)	4.0 (101.6)	11.1 (281.9)	32.0 (812.8)	38.0 (965.2)	2.5 (63.5)	2.5 (63.5)	3.0 (76.2)	12	6	1832	1496	–	B
86644M	4.0 (101.6)	4.0 (101.6)	11.1 (281.9)	36.0 (914.4)	42.2 (1071.9)	2.5 (63.5)	2.5 (63.5)	3.1 (78.7)	12	6	1550	1300	–	HD 86529
86653M	4.0 (101.6)	4.0 (101.6)	11.1 (281.9)	30.0 (762.0)	36.2 (919.5)	2.5 (63.5)	2.5 (63.5)	3.1 (78.7)	12	6	1580	1320	–	B, HD 86500M
86664M	4.0 (101.6)	4.0 (101.6)	8.3 x 11.5 (210.8 x 292.1)	32.0 (812.8)	37.2 (944.9)	2.5 (63.5)	2.5 (63.5)	2.6 (66.0)	12	6	1500	1250	–	HD 86505
86752M	4.0 (101.6)	5.0 (127.0)	10.5 x 15.4 (2.67 x 391.2)	34.0 (863.6)	40.5 (1028.7)	4.25 (107.95)	4.3 (108.0)	3.3 (82.6)	6	12	1500	1220	–	B, F
86753M	4.0 (101.6)	5.0 (127.0)	10.5 x 15.4 (2.67 x 391.2)	44.0 (1117.6)	50.5 (1282.7)	3.1 (78.7)	3.1 (78.7)	3.3 (82.6)	6	12	1870	1530	–	B, F
22152T	4.0 (101.6)	4.1 (104.1) O.D.	6.1 x 10.1 (154.9 x 256.5)	18.2 (462.3)	26.6 (675.6)	2.4 (61.0)	2.4 (61.0)	2.0 (50.8)	–	–	1410	1150	–	A, I
86504M	4.0 (101.6) O.D.	4.0 (101.6)	8.3 x 11.5 (210.8 x 292.1)	32.0 (812.8)	38.7 (983.0)	2.5 (63.5)	2.5 (63.5)	4.1 (104.1)	12	6	1400	1240	–	–
86506M	4.0 (101.6) O.D.	4.0 (101.6)	8.3 x 11.5 (210.8 x 292.1)	27.0 (685.8)	33.7 (856.0)	2.5 (63.5)	2.5 (63.5)	4.1 (104.1)	12	6	1500	1250	–	–
86147M	5.0 (127.0)	5.0 (127.0)	10.0 x 15.0 (254.0 x 381.0)	26.0 (660.4)	33.0 (838.2)	3.3 (83.8)	3.3 (83.8)	3.0 (76.2)	12	6	2950	2500	–	A
86606M	5.0 (127.0)	5.0 (127.0)	10.5 x 15.3 (266.7 x 388.6)	44.0 (1117.6)	50.5 (1282.7)	3.1 (78.7)	3.1 (78.7)	3.2 (81.3)	6	12	2700	2200	–	F
86705M	5.0 (127.0)	5.0 (127.0)	11.1 (281.9)	44.0 (1117.6)	50.5 (1282.7)	2.5 (63.5)	2.5 (63.5)	3.2 (81.3)	12	6	1900	1590	–	–

Standard Line Mufflers

Type 2

End In/Opposite End Out

Both Offset

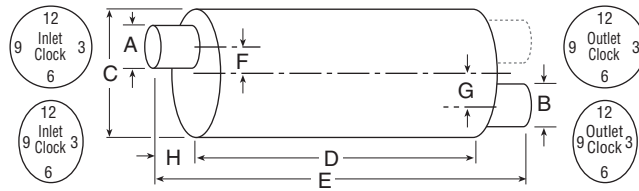

Part Number	A Inlet I.D. in (mm)	B Outlet I.D. in (mm)	C Body Size in (mm)	D Body Length in (mm)	E Overall Length in (mm)	F Inlet Offset in (mm)	G Outlet Offset in (mm)	H Inlet Length in (mm)	Inlet Clock Position	Outlet Clock Position	Max. Flow Rate			Notes*
											@ 3" Hg	@ 2" Hg	@ 1" Hg	
22705T	5.0 (127.0)	5.1 (129.5) O.D.	8.5 x 11.8 (215.9 x 299.7)	25.0 (635.0)	33.3 (845.8)	2.8 (71.1)	2.8 (71.1)	3.5 (88.9)	12	6	2130	1745	–	A, I, C, F
86180M	6.0 (152.4)	6.0 (152.4)	10.0 x 15.0 (254.0 x 381.0)	31.7 (805.2)	42.5 (1079.5)	3.6 (91.4)	3.6 (91.4)	5.4 (137.2)	12	6	3800	3170	–	A

Standard Line Mufflers

Type 2A

Dual End In/

Opposite End Out

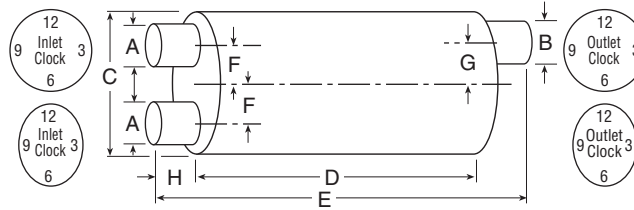

Part Number	A Inlet I.D. in (mm)	B Outlet I.D. in (mm)	C Body Size in (mm)	D Body Length in (mm)	E Overall Length in (mm)	F Inlet Offset in (mm)	G Outlet Offset in (mm)	H Inlet Length in (mm)	Inlet Clock Position	Outlet Clock Position	Max. Flow Rate			Notes*
											@ 3" Hg	@ 2" Hg	@ 1" Hg	
86183M	2.5-2.5 (63.5-63.5)	2.75 (69.85)	8.5 (215.9)	30.0 (762.0)	39.0 (990.6)	1.75 (44.5)	2.0 (50.8)	2.5 (63.5)	1:30-10:30	12	1200	1000	—	—
86522M	2.5-2.5 (63.5-63.5)	2.75 (69.85)	8.5 (215.9)	30.0 (762.0)	39.0 (990.6)	1.75 (44.5)	2.0 (50.8)	2.5 (63.5)	1:30-10:30	12	950	790	—	HD 86183M
86135M	2.5-2.5 (63.5-63.5)	3.0 (76.2)	8.5 (215.9)	38.0 (965.2)	43.0 (1092.2)	1.75 (44.5)	2.0 (50.8)	2.5 (63.5)	1:30-10:30	6	850	710	—	—
86184M	2.5-2.5 (63.5-63.5)	3.0 (76.2)	8.5 (215.9)	31.2 (792.5)	36.2 (919.5)	1.75 (44.5)	2.0 (50.8)	2.5 (63.5)	1:30-10:30	6	780	650	—	—
86695M	2.5-2.5 (63.5-63.5)	3.5 (88.9) Spout	8.4 (213.4)	30.0 (762.0)	40.7 (1033.8)	1.75 (44.5)	2.0 (50.8)	2.5 (63.5)	1:30-10:30	6	1350	1100	—	SS
86557M	2.5-2.5 (63.5-63.5) Flange	4.0 (101.6)	9.9 (251.5)	40.0 (1016.0)	50.0 (1270.0)	1.75 (44.5)	2.0 (50.8)	3.3-5.8 (83.8-132.1)	1:30-10:30	6	800	650	—	B, E, F, SS
86722M	2.5-2.5 (63.5-63.5) Flange	3.0 (76.2) O.D.	8.7 (221.0)	30.0 (762.0)	39.0 (990.6)	1.75 (44.5)	2.0 (50.8)	3.3-5.8 (83.8-132.1)	1:30-10:30	6	800	650	—	B, E, F, SS
86185M	2.75-2.75 (69.85-69.85)	4.0 (101.6)	8.3 × 11.5 (210.8 x 292.1)	27.7 (703.6)	32.7 (830.6)	0.5-3.5 (12.7-88.9)	1.8 (45.7)	2.7 (68.6)	0, 12	12	1300	1090	—	B
86538M	2.75-2.75 (69.85-69.85)	4.0 (101.6)	8.4 × 11.5 (213.4 x 292.1)	27.7 (703.6)	32.7 (830.6)	0.5-3.5 (12.7-88.9)	1.8 (45.7)	2.7 (68.6)	0, 12	12	1160	970	—	B, F

Standard Line Mufflers

Type 3

End In/End Out –
Same End

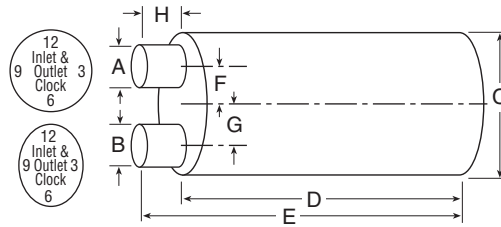

Part Number	A Inlet I.D. in (mm)	B Outlet I.D. in (mm)	C Body Size in (mm)	D Body Length in (mm)	E Overall Length in (mm)	F Inlet Offset in (mm)	G Outlet Offset in (mm)	H Inlet Length in (mm)	Inlet Clock Position	Outlet Clock Position	Max. Flow Rate			Notes*
											@ 3" Hg	@ 2" Hg	@ 1" Hg	
12385T	3.0 (76.2)	2.5 (63.5) O.D.	6.0 x 14.0 (152.4 x 355.6)	18.0 (457.2)	22.0 (558.8)	2.6 (66.0)	2.5 (63.5)	2.5 (63.5)	12	6	845	690	–	B, F
86774M	3.5 (88.9)	4.0 (101.6)	8.2 x 11.5 (208.3 x 292.1)	32.0 (812.8)	34.9 (886.5)	2.5 (63.5)	2.5 (63.5)	2.9 (73.7)	12	6	1900	1550	–	–
86755M	3.5 (88.9)	4.0 (101.6) O.D.	8.2 x 11.5 (208.3 x 292.1)	32.0 (812.8)	38.4 (975.4)	2.5 (63.5)	2.5 (63.5)	2.9 (73.7)	12	6 (90° Elbow)	1500	1220	–	–
15088T	3.6 (91.4)	3.0 (76.2)	8.2 x 11.5 (208.3 x 292.1)	13.5 (342.9)	15.5 (393.7)	3.2 (81.3)	2.8 (71.1)	0.2 (5.1)	12	6	675	550	–	C
86115M	4.0 (101.6)	4.0 (101.6)	10.0 x 15.0 (254.0 x 381.0)	26.0 (660.4)	29.2 (741.7)	4.0 (101.6)	4.0 (101.6)	3.2 (81.3)	12	6	1600	1350	–	–
86133M	4.0 (101.6)	4.0 (101.6)	10.1 (256.5)	28.0 (711.2)	31.0 (787.4)	2.4 (61.0)	2.4 (61.0)	3.0 (76.2)	12	6	1700	1420	–	–
12036A	4.0 (101.6) NPT	4.0 (101.6) NPT	16.0 (406.4)	22.0 (558.8)	24.0 (609.6)	2.5 (63.5)	4.0 (101.6)	2.0 (50.8)	7	10	1305	1065	–	–
86543M	4.0 (101.6)	5.0 (127.0)	10.0 x 15.0 (254.0 x 381.0)	27.0 (685.8)	31.0 (787.4)	4.4 (111.8)	4.4 (111.8)	4.0 (101.6)	6	12	1970	1650	–	–
86116M	5.0 (127.0)	5.0 (127.0)	10.0 x 15.0 (254.0 x 381.0)	36.0 (914.4)	39.0 (990.6)	4.0 (101.6)	4.0 (101.6)	3.0 (76.2)	12	6	2800	2300	–	–
86775M	5.0 (127.0)	5.0 (127.0)	10.0 x 15.0 (254.0 x 381.0)	42.0 (1066.8)	45.0 (1143.0)	4.0 (101.6)	4.0 (101.6)	3.0 (76.2)	12	6	2850	2300	–	–

Standard Line Mufflers

Type 4

End In/Opposite End Out –
Outlet Offset

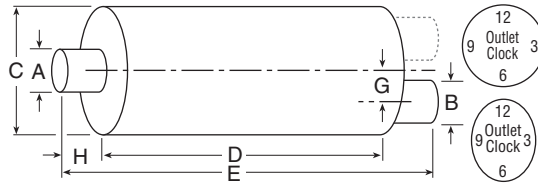

Part Number	A Inlet I.D. in (mm)	B Outlet I.D. in (mm)	C Body Size in (mm)	D Body Length in (mm)	E Overall Length in (mm)	F Inlet Offset in (mm)	G Outlet Offset in (mm)	H Inlet Length in (mm)	Inlet Clock Position	Outlet Clock Position	Max. Flow Rate			Notes*
											@ 3" Hg	@ 2" Hg	@ 1" Hg	
11669T	2.5 (63.5)	1.8 (45.7) O.D.	4.6 x 8.4 (116.8 x 213.4)	19.0 (482.6)	33.5 (850.9)	0	2.8 (69.9)	5.5 (139.7)	0	12	325	265	–	A
18202T	3.0 (76.2)	3.3 (83.8) O.D.	6.1 x 10.1 (154.9 x 256.5)	32.0 (812.8)	48.0 (1,219.2)	–	0.4 (10.2)	4.0 (101.6)	–	4:30	1120	915	–	A
86200M	4.0 (101.6)	4.0 (101.6)	10.3 (261.6)	44.5 (1,130.3)	51.0 (1,295.4)	0	2.4 (61.0)	3.0 (76.2)	0	6	1900	1590	–	A, B, F
86203M	4.0 (101.6)	4.0 (101.6)	10.1 x 15.1 (256.5 x 383.5)	36.0 (914.4)	43.0 (1,092.2)	–	4.5 (114.3)	3.0 (76.2)	–	6	1750	1460	–	A, B

Standard Line Mufflers

Type 5

Side In/End Out

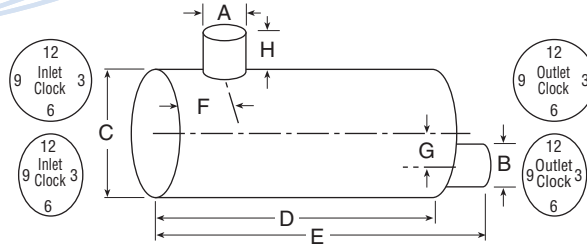

Part Number	A Inlet I.D. in (mm)	B Outlet I.D. in (mm)	C Body Size in (mm)	D Body Length in (mm)	E Overall Length in (mm)	F Inlet Offset in (mm)	G Outlet Offset in (mm)	H Inlet Length in (mm)	Inlet Clock Position	Outlet Clock Position	Max. Flow Rate			Notes*
											@ 3" Hg	@ 2" Hg	@ 1" Hg	
14472T	1.37 (34.80))	1.4 (34.8)	3.2 (81.3)	11.0 (279.4)	15.75 (400.05)	1.4 (35.6)	0	1.1 (27.9)	6	0	200	160	–	C
12417T	1.7 (43.2)	1.8 (45.7)	5.0 (127.0)	10.1 (256.5)	14.1 (358.1)	3.25 (82.55)	1.25 (31.75)	1.8 (45.7)	6	6	290	240	–	–
14099T	1.9 (48.3)	2.0 (50.8) O.D.	4.6 (116.8)	15.8 (401.3)	17.8 (452.1)	2.2 (55.9)	–	2.0 (50.8)	12	0	322	266	–	G
200773N	2.0 (50.8)	2.0 (50.8)	6.0 (152.4)	8.0 (203.2)	9.0 (228.6)	1.0 (25.4)	2.0 (50.8)	–	10:30	12	544	444	–	–
86190M	2.0 (50.8)	2.0 (50.8)	6.1 (154.9)	18.8 (477.5)	21.5 (546.1)	3.5 (88.9)	1.4 (35.6)	2.0 (50.8)	6	3	350	300	–	–
13994T	2.0 (50.8)	2.1 (53.3) O.D.	4.6 (116.8)	13.2 (335.3)	18.5 (469.9)	2.0 (50.8)	0.0 (0.0)	2.0 (50.8)	6	0	440	360	–	G
13909T	2.1 (53.3) Flange	1.8 (45.7) O.D.	4.6 x 8.4 (116.8 x 213.4)	18.0 (457.2)	20.0 (508.0)	5.0 (127.0)	2.7 (68.6)	2.7 (68.6)	6	3	295	240	–	–
17123N	2.125 (53.98) O.D.	2.5 (63.5)	4.12 x 9.0 (104.69 x 228.6)	19.0 (482.6)	22.8 (579.1)	2.5 (63.5)	–	1.4 (35.6)	3	3	456	373	–	G, Spark Arrester
28413N	2.5 (63.5)	2.5 (63.5)	7.1 (180.3)	15.5 (393.7)	17.0 (431.8)	3.5 (88.9)	2.0 (50.8)	3.0 (76.2)	4	12	501	409	–	Spark Arrester
86191M	2.5 (63.5)	2.5 (63.5)	6.6 (167.6)	20.8 (528.3)	23.5 (596.9)	3.5 (88.9)	1.4 (35.6)	2.7 (68.6)	6	3	640	535	–	–
25582N	3.0 (76.2)	3.0 (76.2)	7.0 (177.8)	15.0 (381.0)	27.0 (685.8)	7.0 (177.8)	–	2.75 (69.85)	6	0	862	703	–	–
28544N	3.0 (76.2)	3.0 (76.2)	7.12 (180.85)	15.0 (381.0)	17.0 (431.8)	7.0 (177.8)	–	2.75 (69.85)	6	0	577	471	–	–
86192M	3.0 (76.2)	3.0 (76.2)	8.5 (215.9)	27.0 (685.8)	29.5 (749.3)	4.5 (114.3)	2.0 (50.8)	2.5 (63.5)	6	3	860	700	–	–
23426N	3.0 (76.2)	3.125 (79.38)	7.12 (180.85)	15.0 (381.0)	28.5 (723.9)	7.0 (177.8)	0.0 (0.0)	6.0 (152.4)	6	0	1030	841	–	–
13900T	3.1 (78.7)	3.0 (76.2) O.D.	10.1 (256.5)	17.3 (439.4)	24.5 (622.3)	14.5 (368.3)	1.9 (48.3)	4.5 (114.3)	6	12	695	565	–	–

Standard Line Mufflers

Type 5

Side In/End Out

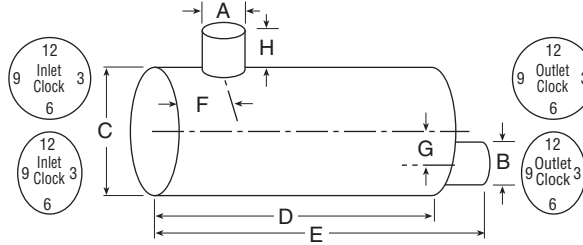

Part Number	A Inlet I.D. in (mm)	B Outlet I.D. in (mm)	C Body Size in (mm)	D Body Length in (mm)	E Overall Length in (mm)	F Inlet Offset in (mm)	G Outlet Offset in (mm)	H Inlet Length in (mm)	Inlet Clock Position	Outlet Clock Position	Max. Flow Rate			Notes*
											@ 3" Hg	@ 2" Hg	@ 1" Hg	
86193M	3.5 (88.9)	3.5 (88.9)	8.3 x 11.5 (210.8 x 292.1)	26.0 (660.4)	29.2 (741.7)	3.4 (86.4)	2.5 (63.5)	2.5 (63.5)	9	12	1100	920	–	–
17120T	3.5 (88.9) Flared	3.4 (86.4) O.D.	10.1 (256.5)	17.5 (444.5)	22.5 (571.5)	13.2 (335.3)	2.4 (61.0)	5.3 (134.6)	6	3	1125	920	–	B, C, F
25922N	4.0 (101.6)	4.0 (101.6)	10.12 (257.05)	24.0 (609.6)	30.0 (762.0)	–	–	2.75 (69.85)	1266	1033	–	–	–	–
86562M	4.0 (101.6)	4.0 (101.6)	8.3 x 11.5 (210.8 x 292.1)	16.3 (414.0)	21.9 (556.3)	3.5 (88.9)	2.4 (61.0)	9.1 (231.1)	12	9	1700	1450	–	A
86598M	4.0 (101.6)	4.0 (101.6)	10.3 x 15.3 (261.6 x 388.6)	27.7 (703.6)	29.9 (759.5)	22.5 (571.5)	4.3 (109.2)	2.0 (50.8)	5:30	12	1550	1290	–	B, F
86607M	4.0 (101.6)	4.0 (101.6)	8.3 x 11.5 (210.8 x 292.1)	28.5 (723.9)	31.1 (789.9)	24.2 (614.7)	2.5 (63.5)	2.8 (71.1)	5:30	12	1650	1375	–	–
86724M	4.0 (101.6)	4.0 (101.6)	11.1 (281.9)	36.0 (914.4)	39.0 (990.6)	4.3 (109.2)	2.5 (63.5)	3.1 (78.7)	9	12	1320	1100	–	–
15572T	4.0 (101.6)	4.1 (104.1)	6.1 x 10.1 (154.9 x 256.5)	26.0 (660.4)	30.5 (774.7)	4.2 (106.7)	2.4 (61.0)	2.7 (68.6)	6	3	1185	970	–	C, D, I
86542M	4.0 (101.6)	5.0 (127.0)	10.0 x 15.0 (254.0 x 381.0)	21.0 (533.4)	25.1 (637.5)	3.1 (78.7)	4.4 (111.8)	3.5 (88.9)	12	12	1900	1590	–	A
86751M	4.0 (101.6)	5.0 (127.0)	10.0 x 15.0 (254.0 x 381.0)	27.0 (685.8)	29.8 (756.9)	22.4 (569.0)	3.6 (91.4)	3.0 (76.2)	5:30	12	1850	1510	–	–
86771M	4.0 (101.6)	5.0 (127.0)	9.0 (228.6)	44.5 (1130.3)	48.0 (1219.2)	3.8 (96.5)	0.0 (0.0)	2.2 (55.9)	6	0	2200	1800	–	A
86149M	4.0 (101.6)	3.8 (96.5) O.D.	10.0 x 15.0 (254.0 x 381.0)	16.0 (406.4)	20.1 (510.5)	3.1 (78.7)	4.4 (111.8)	3.3 (83.8)	12	12	1350	1125	–	A
19141N	5.0 (127.0)	5.0 (127.0)	12.72 (323.09)	24.0 (609.6)	28.0 (711.2)	2.4 (61.0)	4.0 (101.6)	4.0 (101.6)	4	12	2728	2227	–	–

Standard Line Mufflers

Type 5

Side In/End Out

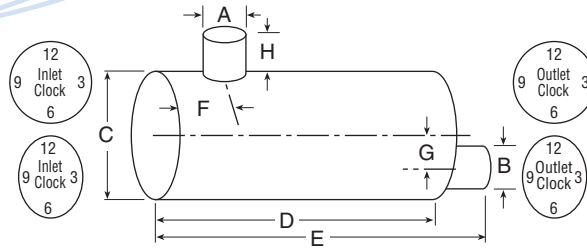

Part Number	A Inlet I.D. in (mm)	B Outlet I.D. in (mm)	C Body Size in (mm)	D Body Length in (mm)	E Overall Length in (mm)	F Inlet Offset in (mm)	G Outlet Offset in (mm)	H Inlet Length in (mm)	Inlet Clock Position	Outlet Clock Position	Max. Flow Rate			Notes*
											@ 3" Hg	@ 2" Hg	@ 1" Hg	
86194M	5.0 (127.0)	5.0 (127.0)	10.0 × 15.0 (254.0 × 381.0)	36.0 (914.4)	40.0 (1016.0)	6.1 (154.9)	3.1 (78.7)	3.0 (76.2)	9	12	2200	1850	–	–
86526M	5.0 (127.0)	5.0 (127.0)	10.1 (256.5)	44.5 (1130.3)	48.25 (1225.55)	5.5 (139.7)	0.0 (0.0)	2.5 (63.5)	6	0	2700	2250	–	A
86570M	5.0 (127.0)	5.0 (127.0)	10.0 × 15.0 (254.0 × 381.0)	27.0 (685.8)	29.8 (756.9)	22.4 (569.0)	3.4 (86.4)	2.0 (50.8)	5:30	12	2750	2240	–	B
86685M	5.0 (127.0)	5.0 (127.0)	10.0 × 15.0 (254.0 × 381.0)	18.0 (457.2)	20.5 (520.7)	5.0 (127.0)	1.5 (38.1)	5.5 (139.7)	6	12	2760	2250	–	A
86757M	5.0 (127.0)	5.0 (127.0)	12.3 × 15.2 (312.4 × 386.1)	27.0 (685.8)	29.8 (756.9)	22.4 (569.0)	3.6 (91.4)	3.0 (76.2)	5:30	11	2800	2290	–	B, F

Standard Line Mufflers

Type 7

End In/Side Out

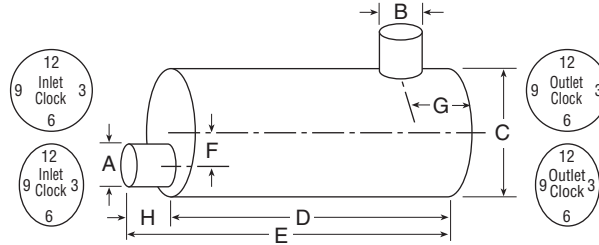

Part Number	A Inlet I.D. in (mm)	B Outlet I.D. in (mm)	C Body Size in (mm)	D Body Length in (mm)	E Overall Length in (mm)	F Inlet Offset in (mm)	G Outlet Offset in (mm)	H Inlet Length in (mm)	Inlet Clock Position	Outlet Clock Position	Max. Flow Rate			Notes*
											@ 3" Hg	@ 2" Hg	@ 1" Hg	
86513M	2.75-2.75 (69.9- 69.9)	4.0 (101.6) O.D.	8.3 X 11.5 (210.8 X 292.1)	28.5 (723.9)	31.0 (787.4)	0.5-3.5 (12.7- 88.9)	10.6 (269.2)	2.5 (63.5)	0, 12	2	1370	1140	-	-
86510M	3.5 (88.9)	4.0 (101.6)	8.3 X 11.5 (210.8 X 292.1)	28.0 (711.2)	30.9 (784.9)	2.5 (63.5)	16.2 (411.5)	2.9 (73.7)	12	2:30	1450	1210	-	-
86537M	3.5 (88.9)	4.0 (101.6)	8.3 X 11.5 (210.8 X 292.1)	32.0 (812.8)	34.9 (886.5)	2.5 (63.5)	20.2 (513.1)	2.9 (73.7)	12	2:30	1550	1300	-	-
86548M	3.5 (88.9)	4.0 (101.6)	8.3 X 11.5 (210.8 X 292.1)	32.0 (812.8)	34.9 (886.5)	2.5 (63.5)	24.7 (627.4)	2.9 (73.7)	12	8:30	1600	1340	-	-
86511M	3.5 (88.9)	4.0 (101.6) O.D.	8.3 X 11.5 (210.8 X 292.1)	28.0 (711.2)	30.9 (784.9)	2.5 (63.5)	16.2 (411.5)	2.9 (73.7)	12	8:30	1500	1250	-	-
86545M	3.5 (88.9)	4.0 (101.6) O.D.	8.3 X 11.5 (210.8 X 292.1)	32.0 (812.8)	34.9 (886.5)	2.5 (63.5)	20.2 (513.1)	2.9 (73.7)	12	8:30	1450	1210	-	-
86754M	3.5 (88.9)	4.0 (101.6) O.D.	8.0 X 11.5 (203.2 X 292.1)	32.0 (812.8)	34.9 (886.5)	2.5 (63.5)	10.8 (274.3)	2.9 (73.7)	12	8:30	1600	1300	-	-
86777M	3.5 (88.9)	4.0 (101.6) O.D.	8.3 X 11.5 (210.8 X 292.1)	32.0 (812.8)	34.9 (886.5)	2.5 (63.5)	24.7 (627.4)	2.9 (73.7)	12	8:30	2050	1680	-	-
17275T	3.6 (91.4)	3.5 (88.9) O.D.	8.9 X 12.1 (226.1 X 307.3)	17.2 (436.9)	17.5 (444.5)	3.1 (78.7)	4.4 (111.8)	0.2 (5.1)	6	11	1480	1210	-	B, C, F, I
86148M	4.0 (101.6)	4.0 (101.6)	10.1 (256.5)	28.0 (711.2)	30.5 (774.7)	2.4 (61.0)	7.3 (185.4)	2.5 (63.5)	6	1	1960	1600	-	-
86151M	4.0 (101.6)	4.0 (101.6)	10.1 (256.5)	27.8 (706.1)	30.8 (782.3)	2.4 (61.0)	24.3 (617.2)	3.0 (76.2)	6	2:30	1600	1350	-	-
86152M	4.0 (101.6)	4.0 (101.6)	10.1 (256.5)	36.0 (914.4)	38.9 (988.1)	2.4 (61.0)	5.5 (139.7)	2.9 (73.7)	12	6	1250	1021	-	-

Standard Line Mufflers

Type 7

End In/Side Out

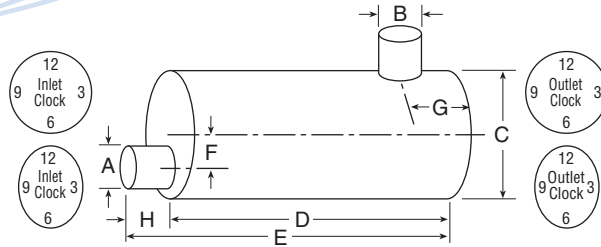

Part Number	A Inlet I.D. in (mm)	B Outlet I.D. in (mm)	C Body Size in (mm)	D Body Length in (mm)	E Overall Length in (mm)	F Inlet Offset in (mm)	G Outlet Offset in (mm)	H Inlet Length in (mm)	Inlet Clock Position	Outlet Clock Position	Max. Flow Rate			Notes*
											@ 3" Hg	@ 2" Hg	@ 1" Hg	
86220M	4.0 (101.6)	4.0 (101.6)	10.0 × 15.0 (254.0 x 381.0)	36.0 (914.4)	39.0 (990.6)	3.8 (96.5)	28.5 (723.9)	3.0 (76.2)	12	6	1270	1060	–	–
86221M	4.0 (101.6)	4.0 (101.6)	11.1 (281.9)	36.0 (914.4)	39.0 (990.6)	2.5 (63.5)	4.2 (106.7)	3.5 (88.9)	2	12	1330	1110	–	–
86501M	4.0 (101.6)	4.0 (101.6)	11.1 (281.9)	30.0 (762.0)	33.0 (838.2)	2.5 (63.5)	4.2 (106.7)	3.5 (88.9)	2	12	1950	1625	–	–
86530M	4.0 (101.6)	4.0 (101.6)	11.1 (281.9)	36.0 (914.4)	39.0 (990.6)	1.5 (38.1)	28.5 (723.9)	3.0 (76.2)	6	12	1720	1440	–	–
86597M	4.0 (101.6)	4.0 (101.6)	8.3 X 11.5 (210.8 X 292.1)	28.0 (711.2)	30.9 (784.9)	2.5 (63.5)	16.2 (411.5)	2.3 (58.4)	12	4	1510	1270	–	–
86697M	4.0 (101.6)	4.0 (101.6)	11.1 (281.9)	36.0 (914.4)	39.0 (990.6)	2.5 (63.5)	32.1 (815.3)	3.0 (76.2)	2	12	1700	1400	–	B
86698M	4.0 (101.6)	4.0 (101.6)	11.1 (281.9)	36.0 (914.4)	39.0 (990.6)	2.5 (63.5)	32.1 (815.3)	3.0 (76.2)	10	12	1700	1400	–	B
86608M	4.0 (101.6)	4.0 (101.6) O.D.	10.0 × 15.0 (254.0 x 381.0)	26.0 (660.4)	29.5 (749.3)	3.5 (88.9)	21.5 (546.1)	3.5 (88.9)	6	12	1650	1375	–	C
20445A	5.0 (127.0)	5.0 (127.0)	10.0 × 15.0 (254.0 x 381.0)	36.0 (914.4)	39.0 (990.6)	4.0 (101.6)	28.5 (723.9)	3.8 (96.5)	6	12	2212	1806	–	–
22794A	5.0 (127.0)	5.0 (127.0)	10.0 × 15.0 (254.0 x 381.0)	36.0 (914.4)	39.0 (990.6)	3.5 (88.9)	9.25 (234.95)	3.0 (76.2)	0	7	1751	1429	–	–
24050A	5.0 (127.0)	5.0 (127.0)	11.0 (279.4)	50.0 (1270.0)	53.0 (1346.2)	0	14.0 (355.6)	3.0 (76.2)	0	12	2575	2102	–	–
24051A	5.0 (127.0)	5.0 (127.0)	11.0 (279.4)	50.0 (1270.0)	53.0 (1346.2)	0	14.0 (355.6)	3.0 (76.2)	0	12	1276	1042	–	–
86503M	5.0 (127.0)	5.0 (127.0)	10.0 × 15.0 (254.0 x 381.0)	36.0 (914.4)	38.8 (985.5)	4.0 (101.6)	28.5 (723.9)	2.8 (71.1)	12	6	2300	1920	–	–
86672M	5.0 (127.0)	5.0 (127.0)	11.1 (281.9)	36.0 (914.4)	39.2 (995.7)	2.7 (68.6)	28.5 (723.9)	3.2 (81.3)	6	12	1900	1590	–	–

Standard Line Mufflers

Type 7

End In/Side Out

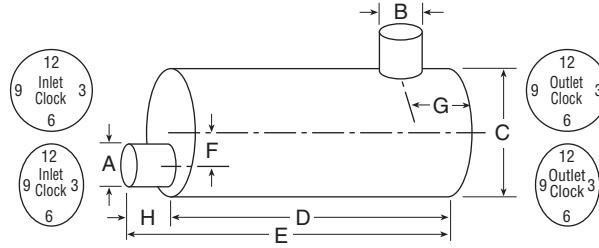

Part Number	A Inlet I.D. in (mm)	B Outlet I.D. in (mm)	C Body Size in (mm)	D Body Length in (mm)	E Overall Length in (mm)	F Inlet Offset in (mm)	G Outlet Offset in (mm)	H Inlet Length in (mm)	Inlet Clock Position	Outlet Clock Position	Max. Flow Rate			Notes*
											@ 3" Hg	@ 2" Hg	@ 1" Hg	
86704M	5.0 (127.0)	5.0 (127.0)	10.0 × 15.0 (254.0 × 381.0)	36.0 (914.4)	39.0 (990.6)	2.5 (63.5)	4.8 (121.9)	3.0 (76.2)	12	6	1900	1590	–	–
86655M	5.0 (127.0) O.D.	5.0 (127.0) O.D.	12.1 (307.3)	36.0 (914.4)	40.0 (1016.0)	0	14.5 (368.3)	4.0 (101.6)	0	12	2700	2250	–	–

Standard Line Mufflers

Type 8

Side In / Side Out

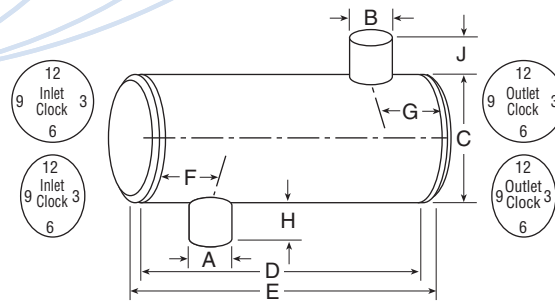

Part Number	A Inlet I.D. in (mm)	B Outlet I.D. in (mm)	C Body Size in (mm)	D Body Length in (mm)	E Overall Length in (mm)	F Inlet Offset in (mm)	G Outlet Offset in (mm)	H Inlet Length in (mm)	Inlet Clock Position	Outlet Clock Position	Max. Flow Rate			Notes*
											@ 3" Hg	@ 2" Hg	@ 1" Hg	
14490T	1.4 (35.6)	1.37 (34.80) O.D.	5.0 (127.0)	12.4 (315.0)	12.4 (315.0)	1.2 (30.5)	1.0 (25.4)	1.2 (30.5)	12	7	225	185	–	C
86723M	4.0 (101.6)	4.0 (101.6)	11.1 (281.9)	36.0 (914.4)	36.0 (914.4)	4.3 (109.2)	17.3 (439.4)	3.1 (78.7)	12	2:30	1320	1100	–	–
86727M	4.0 (101.6)	4.0 (101.6)	11.1 (281.9)	36.0 (914.4)	36.0 (914.4)	4.3 (109.2)	17.3 (439.4)	3.1 (78.7)	12	2:30	1400	1140	–	–
86725M	4.0 (101.6)	4.0 (101.6) O.D.	11.1 (281.9)	36.0 (914.4)	36.0 (914.4)	4.3 (109.2)	6.8 (172.7)	3.1 (78.7)	12	3	1410	1150	–	–
86756M	4.0 (101.6)	4.0 (101.6) O.D.	11.1 (281.9)	36.0 (914.4)	36.0 (914.4)	4.25 (107.95)	13.5 (342.9)	3.1 (78.7)	12	2:30	1720	1400	–	–
21326A	5.0 (127.0)	4.5 (114.3) O.D.	11.1 (281.9)	18.5 (469.9)	18.5 (469.9)	3.6 (91.4)	3.4 (86.4)	5.3 (134.6)	6	4	1750	1400	–	F
200822N	1.625 (41.28) Flange	2.0 (50.8)	5.65 (143.51)	12.0 (304.8)	12.0 (304.8)	2.75 (69.85)	3.0 (76.2)	0.6 (15.2)	12	6	250	204	–	–

Standard Line Mufflers

*Installation Notes

- A Outlet end of muffler is domed for vertical installation
- B Muffler shell is double wall for shell noise/temperature reduction
- C Muffler has mounting bracket for specific installation requirements
- D Muffler has heat shield attached
- E Muffler has flanged connection for ball and socket type joint
- F Muffler is insulated for temperature/sound reduction
- G Spark arresting muffler
- H Designed for horizontal installation – inlet is 90° elbow
- I Muffler provides aspirating function
- J Muffler has curved outlet stack
- HD Muffler is heavy duty version of the part number listed
- SS Muffler is stainless steel version of the part number listed
- EM Economy Muffler

Engine Data

1. To calculate **exhaust flow** (exhaust CFM (ft³/min) use:

$$\text{Exhaust CFM} = \frac{\text{Disp.} \times \text{RPM} \times \text{E} \times (\text{Temp.} + 460)}{\text{C} \times 941760}$$

2. To calculate **intake flow** (intake CFM) use:

$$\text{Intake CFM} = \frac{\text{Disp.} \times \text{RPM} \times \text{E}}{\text{C} \times 1728}$$

3. To calculate **exhaust flow** (exhaust CFM) if intake flow (intake CFM) is known, use:

$$\text{Exhaust CFM} = 2.7 \times \text{intake CFM (diesel)} \text{ or } 3.1 \times \text{intake CFM (gas)}$$

Disp. = Engine displacement in cubic inches (to convert liters to cubic inches, multiply by 61.002)

RPM = Engine speed at rated HP

E = Efficiency (0.85 for naturally aspirated, 1.4 for turbocharged, 1.6 for turbocharged/aftercooled and 1.2 for engines with scavenging blowers)

Temp. = Exhaust temperature in °F (if not known use 900° for diesel or 1200° for gas)

C = 1 for 2 cycle engines, 2 for 4 cycle engines



Section 4: Off-Highway Industrial Mufflers



Table of Contents

Section 4:

Off-Highway Industrial Mufflers 4-1

Type 1	4-3
End In/Opposite End Out Both On Center	4-3
Type 2	4-4
End In/Opposite End Out Both Offset	4-4
Type 3	4-5
End In/End Out – Same End	4-5
Type 5	4-6
Side In/End Out	4-6
Type 7	4-7
End In/Side Out	4-7
Type 8	4-8
Side In/Side Out	4-8
Single Inlet Round Muffler Accessories	4-9
Outlet Options	4-9
Clamps	4-10
Heat Shields and Brackets.....	4-10
Add-On Glass Packed Resonators.....	4-11



Off-Highway Industrial Mufflers

Type 1

End In/Opposite End Out

Both On Center

- Customized solutions at a standard product price
- Painted black
- All Off-Highway Muffler products subject to lead time

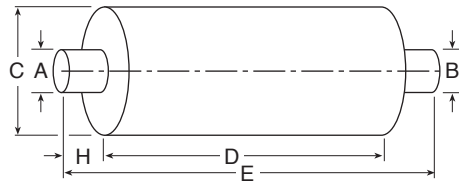

Part Number	A/B Inlet/Outlet I.D. in (mm)	C Body Size in (mm)	D Body Length in (mm)	E Overall Length in (mm)	F Inlet Offset in (mm)	G Outlet Offset in (mm)	H Inlet Length in (mm)	Inlet Clock Position	Outlet Clock Position	Maximum Flow Rate	
										@ 2" Hg	@ 1" Hg
201550N	2.0 (50.8)	6.1 (154.9)	16.0 (406.4)	21.0 (533.4)	—	—	2.50 (63.50)	—	—	392	279
201555N	2.5 (63.5)	6.6 (167.6)	18.0 (457.2)	24.0 (609.6)	—	—	3.00 (76.20)	—	—	614	434
201560N	3.0 (76.2)	8.4 (213.4)	20.0 (508.0)	26.5 (673.1)	—	—	3.25 (82.55)	—	—	883	611
201565N	3.5 (88.9)	9.0 (228.6)	22.0 (558.8)	29.0 (736.6)	—	—	3.50 (88.90)	—	—	1204	851
201570N	4.0 (101.6)	10.1 (256.5)	24.0 (609.6)	32.0 (812.8)	—	—	4.00 (101.60)	—	—	1571	1112
201575N	5.0 (127.0)	12.1 (307.3)	26.0 (660.4)	34.0 (863.6)	—	—	4.00 (101.60)	—	—	2451	1734

Off-Highway Industrial Mufflers

Type 2

End In/Opposite End Out

Both Offset

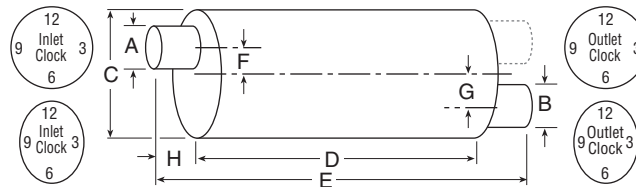

Part Number	A/B Inlet/Outlet I.D. in (mm)	C Body Size in (mm)	D Body Length in (mm)	E Overall Length in (mm)	F Inlet Offset in (mm)	G Outlet Offset in (mm)	H Inlet Length in (mm)	Inlet Clock Position	Outlet Clock Position	Maximum Flow Rate	
										@ 2" Hg	@ 1" Hg
201845N	1.125 (28.58)	4.28 (108.71)	12.0 (304.80)	16.0 (406.4)	1.3 (33.0)	0.95 (24.13)	2.00 (50.80)	12	9	80	57
201848N	1.250 (31.75)	5.0 (127.0)	12.0 (304.80)	16.0 (406.4)	1.4 (35.6)	1.2 (30.5)	2.00 (50.80)	12	9	153	109
201851N	1.250 (31.75)	5.0 (127.0)	15.0 (381.0)	19.0 (482.60)	1.4 (35.6)	1.2 (30.5)	2.00 (50.80)	12	9	153	109
201854N	1.50 (38.10)	5.62 (142.75)	15.0 (381.0)	19.0 (482.60)	1.45 (36.83)	1.45 (36.83)	2.00 (50.80)	12	9	242	171
201551N	2.0 (50.8)	6.1 (154.9)	16.0 (406.4)	21.0 (533.4)	1.50 (38.10)	1.50 (38.10)	2.50 (63.50)	12	6	392	279
201556N	2.5 (63.5)	6.6 (167.6)	18.0 (457.2)	24.0 (609.6)	1.62 (41.15)	1.62 (41.15)	3.00 (76.20)	12	6	614	434
201561N	3.0 (76.2)	8.4 (213.4)	20.0 (508.0)	26.5 (673.1)	2.00 (50.80)	2.00 (50.80)	3.25 (82.55)	12	6	883	611
201566N	3.5 (88.9)	9.0 (228.6)	22.0 (558.8)	29.0 (736.6)	2.10 (53.34)	2.10 (53.34)	3.50 (88.90)	12	6	1204	851
201571N	4.0 (101.6)	10.1 (256.5)	24.0 (609.6)	32.0 (812.8)	2.44 (61.98)	2.44 (61.98)	4.00 (101.60)	12	6	1571	1112
201576N	5.0 (127.0)	12.1 (307.3)	26.0 (660.4)	34.0 (863.6)	2.81 (71.37)	2.81 (71.37)	4.00 (101.60)	12	6	2451	1734

Off-Highway Industrial Mufflers

Type 3

End In/End Out – Same End

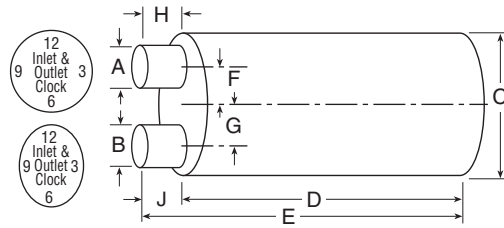

Part Number	A/B Inlet/Outlet I.D. in (mm)	C Body Size in (mm)	D Body Length in (mm)	E Overall Length in (mm)	F Inlet Offset in (mm)	G Outlet Offset in (mm)	H Inlet Length in (mm)	J Outlet Length in (mm)	Inlet Clock Position	Outlet Clock Position	Maximum Flow Rate	
											@ 2" Hg	@ 1" Hg
201553N	2.0 (50.8)	6.1 (154.9)	16.0 (406.4)	19.0 (482.6)	1.50 (38.10)	1.50 (38.10)	2.50 (63.50)	2.50 (63.50)	12	6	392	279
201558N	2.5 (63.5)	6.6 (167.6)	18.0 (457.2)	21.6 (548.6)	1.62 (41.15)	1.62 (41.15)	3.00 (76.20)	3.00 (76.20)	12	6	614	434
201563N	3.0 (76.2)	8.4 (213.4)	20.0 (508.0)	24.0 (609.6)	2.00 (50.80)	2.00 (50.80)	3.25 (82.55)	3.25 (82.55)	12	6	883	611
201568N	3.5 (88.9)	9.0 (228.6)	22.0 (558.8)	26.4 (670.6)	2.10 (53.34)	2.10 (53.34)	3.50 (88.90)	3.50 (88.90)	12	6	1204	851
201573N	4.0 (101.6)	10.1 (256.5)	24.0 (609.6)	28.8 (731.5)	2.44 (61.98)	2.44 (61.98)	4.00 (101.60)	4.00 (101.60)	12	6	1571	1112
201578N	5.0 (127.0)	12.1 (307.3)	26.0 (660.4)	31.4 (797.6)	2.81 (71.37)	2.81 (71.37)	4.00 (101.60)	4.00 (101.60)	12	6	2451	1734

Off-Highway Industrial Mufflers

Type 5

Side In/End Out

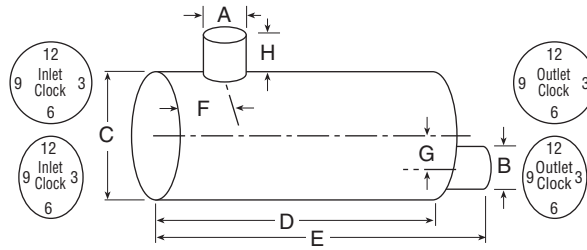

Part Number	A/B Inlet/Outlet I.D. in (mm)	C Body Size in (mm)	D Body Length in (mm)	E Overall Length in (mm)	F Inlet Offset in (mm)	G Outlet Offset in (mm)	H Inlet Length in (mm)	Inlet Clock Position	Outlet Clock Position	Maximum Flow Rate	
										@ 2" Hg	@ 1" Hg
201844N	1.125 (28.58)	4.28 (108.71)	9.0 (228.6)	11.0 (279.4)	1.86 (47.24)	0.95 (24.13)	1.5 (38.1)	12	9	80	57
201847N	1.125 (28.58)	4.28 (108.71)	12.0 (304.80)	14.0 (355.6)	1.86 (47.24)	0.95 (24.13)	1.5 (38.1)	12	9	80	57
201850N	1.250 (31.75)	5.0 (127.0)	12.0 (304.80)	14.0 (355.6)	2.19 (55.63)	1.2 (30.5)	1.5 (38.1)	12	9	153	109
201853N	1.250 (31.75)	5.0 (127.0)	15.0 (381.0)	17.0 (431.8)	2.19 (55.63)	1.2 (30.5)	1.5 (38.1)	12	9	153	109
201859N	1.50 (38.10)	5.62 (142.75)	18.0 (457.2)	20.0 (508.0)	2.2 (55.9)	1.45 (36.83)	2.0 (50.8)	12	9	242	171

Off-Highway Industrial Mufflers

Type 7

End In/Side Out

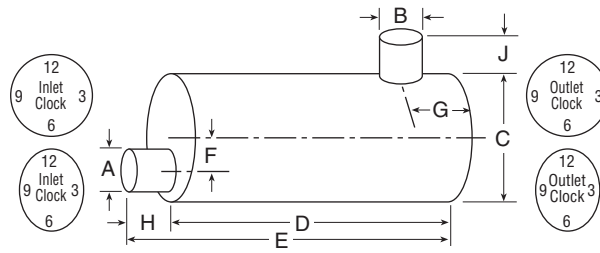

Part Number	A/B Inlet/Outlet I.D. in (mm)	C Body Size in (mm)	D Body Length in (mm)	E Overall Length in (mm)	F Inlet Offset in (mm)	G Outlet Offset in (mm)	H Inlet Length in (mm)	J Outlet Length in (mm)	Inlet Clock Position	Outlet Clock Position	Maximum Flow Rate	
											@ 2" Hg	@ 1" Hg
201552N	2.0 (50.8)	6.1 (154.9)	16.0 (406.4)	19.0 (482.6)	—	2.00 (50.80)	2.50 (63.50)	1.95 (49.53)	0	12	392	279
201557N	2.5 (63.5)	6.6 (167.6)	18.0 (457.2)	21.6 (548.6)	—	2.50 (63.50)	3.00 (76.20)	2.46 (62.48)	0	12	614	434
201562N	3.0 (76.2)	8.4 (213.4)	20.0 (508.0)	24.0 (609.6)	—	3.00 (76.20)	3.25 (82.55)	4.23 (107.44)	0	12	883	611
201567N	3.5 (88.9)	9.0 (228.6)	22.0 (558.8)	26.4 (670.6)	—	3.50 (88.90)	3.50 (88.90)	2.77 (70.36)	0	12	1204	851
201572N	4.0 (101.6)	10.1 (256.5)	24.0 (609.6)	28.8 (731.5)	—	4.00 (101.60)	4.00 (101.60)	2.95 (74.93)	0	12	1571	1112
201577N	5.0 (127.0)	12.1 (307.3)	26.0 (660.4)	31.4 (797.6)	—	5.00 (127.0)	4.00 (101.60)	2.69 (68.33)	0	12	2451	1734

Off-Highway Industrial Mufflers

Type 8

Side In/Side Out

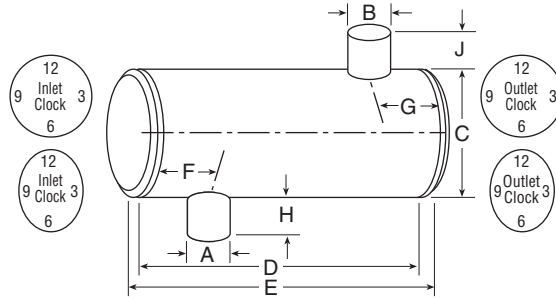

Part Number	A/B Inlet/Outlet I.D. in (mm)	C Body Size in (mm)	D Body Length in (mm)	E Overall Length in (mm)	F Inlet Offset in (mm)	G Outlet Offset in (mm)	H Inlet Length in (mm)	J Outlet Length in (mm)	Inlet Clock Position	Outlet Clock Position	Maximum Flow Rate	
											@ 2" Hg	@ 1" Hg
201843N	1.125 (28.58)	4.28 (108.71)	9.0 (228.6)	9.0 (228.6)	1.86 (47.24)	1.86 (47.24)	1.5 (38.1)	2.0 (50.8)	12	6	80	57
201846N	1.125 (28.58)	4.28 (108.71)	12.0 (304.80)	12.0 (304.80)	1.86 (47.24)	1.86 (47.24)	1.5 (38.1)	5.1 (129.5)	12	6	80	57
201849N	1.250 (31.75)	5.0 (127.0)	12.0 (304.80)	12.0 (304.80)	2.19 (55.63)	2.19 (55.63)	1.5 (38.1)	2.0 (50.8)	12	6	153	109
201852N	1.250 (31.75)	5.0 (127.0)	15.0 (381.0)	15.0 (381.0)	2.19 (55.63)	2.49 (63.25)	1.5 (38.1)	5.6 (142.2)	12	6	153	109
201855N	1.50 (38.10)	5.62 (142.75)	15.0 (381.0)	15.0 (381.0)	2.2 (55.9)	2.2 (55.9)	2.0 (50.8)	2.0 (50.8)	12	6	242	171
201858N	1.50 (38.10)	5.62 (142.75)	18.0 (457.2)	18.0 (457.2)	2.2 (55.9)	2.5 (63.5)	2.0 (50.8)	6.7 (170.2)	12	6	242	171
201554N	2.0 (50.8)	6.1 (154.9)	16.0 (406.4)	17.0 (431.8)	2.00 (50.80)	2.00 (50.80)	1.95 (49.53)	1.95 (49.53)	12	6	392	279
201559N	2.5 (63.5)	6.6 (167.6)	18.0 (457.2)	19.2 (487.7)	2.50 (63.50)	2.50 (63.50)	2.46 (62.48)	2.46 (62.48)	12	6	614	434
201564N	3.0 (76.2)	8.4 (213.4)	20.0 (508.0)	21.5 (546.1)	3.00 (76.20)	3.00 (76.20)	4.23 (107.44)	4.23 (107.44)	12	6	883	611
201569N	3.5 (88.9)	9.0 (228.6)	22.0 (558.8)	23.7 (602.0)	3.50 (88.90)	3.50 (88.90)	2.77 (70.36)	2.77 (70.36)	12	6	1204	851
201574N	4.0 (101.6)	10.1 (256.5)	24.0 (609.6)	25.6 (650.2)	4.00 (101.60)	4.00 (101.60)	2.95 (74.93)	2.95 (74.93)	12	6	1571	1112
201579N	5.0 (127.0)	12.1 (307.3)	26.0 (660.4)	28.8 (731.5)	5.00 (127.0)	5.00 (127.0)	2.69 (68.33)	2.69 (68.33)	12	6	2451	1734

Off-Highway Industrial Mufflers

Single Inlet Round Muffler Accessories

Outlet Options

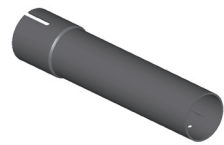

Straight Tail Pipe



45° Tail Pipe



90° Tail Pipe



Spark Arrester

Description	Part Number	Fits Tube Size in (mm)	Sound Reduction*
Tail Pipe – Straight 6" (152 mm) Long	Q714122	1.250 (31.75) O.D.	2 dBA
Tail Pipe – Straight 6" (152 mm) Long	Q714123	1.375 (34.93) O.D.	2 dBA
Tail Pipe – Straight 6" (152 mm) Long	Q714124	1.625 (41.28) O.D.	2 dBA
Tail Pipe – 45°, 3" x 3" Long	Q668167	1.250 (31.75) O.D.	2 dBA
Tail Pipe – 45°, 3" x 3" Long	Q668168	1.375 (34.93) O.D.	2 dBA
Tail Pipe – 45°, 3.5" x 3.5" Long	Q668169	1.625 (41.28) O.D.	2 dBA
Tail Pipe – 90°, 3" x 3" Long	Q668170	1.250 (31.75) O.D.	2 dBA
Tail Pipe – 90°, 3" x 3" Long	Q668171	1.375 (34.93) O.D.	2 dBA
Tail Pipe – 90°, 3.5" x 3.5" Long	Q668172	1.625 (41.28) O.D.	2 dBA
Tail Pipe – Straight 12" Long	Q704762	1.250 (31.75) O.D.	4 dBA
Tail Pipe – Straight 12" Long	Q704763	1.375 (34.93) O.D.	4 dBA
Tail Pipe – Straight 12" Long	Q704765	1.625 (41.28) O.D.	4 dBA
Tail Pipe – 45°, 6" x 6" (152 x 152 mm) Long	Q650812	1.250 (31.75) O.D.	4 dBA
Tail Pipe – 45°, 6" x 6" (152 x 152 mm) Long	Q650813	1.375 (34.93) O.D.	4 dBA
Tail Pipe – 45°, 6" x 6" (152 x 152 mm) Long	Q650815	1.625 (41.28) O.D.	4 dBA
Tail Pipe – 90°, 6" x 6" (152 x 152 mm) Long	Q650822	1.250 (31.75) O.D.	4 dBA
Tail Pipe – 90°, 6" x 6" (152 x 152 mm) Long	Q650823	1.375 (34.93) O.D.	4 dBA
Tail Pipe – 90°, 6" x 6" (152 x 152 mm) Long	Q650825	1.625 (41.28) O.D.	4 dBA
Screen Spark Arrester	49020N	1.000 (29.40) O.D.	3 dBA
Screen Spark Arrester	49024N	1.375 (34.93) O.D.	3 dBA
Screen Spark Arrester	49025N	1.500 (38.10) O.D.	3 dBA
Screen Spark Arrester	49028N	1.750 (44.45) O.D.	3 dBA
Tube Adapter (Fits 49025N)	Q100650	1.500 (38.10) O.D. to 1.375 (34.93) O.D.	–
Tube Adapter	Q100651	1.750 (44.45) O.D. to 1.625 (41.28) O.D.	–

* "Typical" sound reduction for exhaust noise at full load (WOT). Individual results may vary. Sound reduction depends on total vehicle or equipment and other noise contributions.

All spark arresters are screen-type and are U.S.D.A. Qualified.

Off-Highway Industrial Mufflers

Single Inlet Round Muffler Accessories

Clamps

Description	Part Number	Size in (mm)	Color
Band Clamp – Inlet & Outlet Tubes	Q27074A	1.250 (31.75) I.D.	Black
Band Clamp – Inlet & Outlet Tubes	Q02764A	1.375 (34.93) I.D.	Black
Band Clamp – Inlet & Outlet Tubes	Q02737A	1.500 (38.10) I.D.	Black
Band Clamp – Inlet & Outlet Tubes	Q02702A	1.625 (41.28) I.D.	Black
Band Clamp – Inlet & Outlet Tubes	Q02765A	1.750 (44.45) I.D.	Black
U-Bolt Clamp – Inlet & Outlet Tubes	Q186787	1.250 (31.75) I.D.	Black
U-Bolt Clamp – Inlet & Outlet Tubes	Q186788	1.375 (34.93) I.D.	Black
U-Bolt Clamp – Inlet & Outlet Tubes	Q186790	1.500 (38.10) I.D.	Black
U-Bolt Clamp – Inlet & Outlet Tubes	Q187037	1.625 (41.28) I.D.	Black
U-Bolt Clamp – Inlet & Outlet Tubes	Q187038	1.750 (44.45) I.D.	Black
Body Clamp – Muffler Mounting	Q187033A	4.24 (107.70) I.D.	Black
Body Clamp – Muffler Mounting	Q187034A	5.00 (127.00) I.D.	Black
Body Clamp – Muffler Mounting	Q187035A	5.62 (142.75) I.D.	Black



Band Clamp



U-Bolt Clamp



Body Clamp

Heat Shields and Brackets

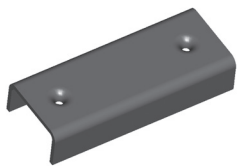

U-Channel Bracket

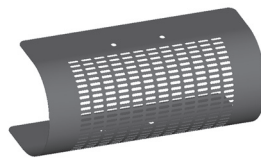

Heat Shield, Slotted

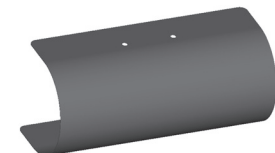

Heat Shield, No Slots

Accessory	Part Number	Description
Heat Shields	N/A	Requires custom designed shield
U-Channel Bracket for Muffler Support and/or Heat Shield Mounting	N/A	Bracket can be welded onto standard mufflers at any location and rotation to create a custom muffler.

Available as an integral component on custom exhaust systems only.
Please contact Customer Assistance.

Off-Highway Industrial Mufflers

Add-On Glass Packed Resonators

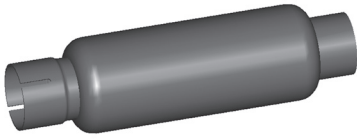

Benefits

- Reduces Sound Level
- Improves Tonal Quality
- Straight Through Design for Low Back Pressure
- Clamps on Existing Tailpipe
- High Temperature Black Paint

Applications

- Commercial Turf Mowers
- Generators
- Utility Vehicles
- Lawn & Garden Tractors

Part Number	Size in (mm)	Fits Tube Size in (mm)	Sound Reduction*
25704N	0.750 (19.05) I.D.	0.750 (19.05) O.D.	4 dBA
25705N	0.875 (22.23) I.D.	0.875 (22.23) O.D.	4 dBA
25706N	1.000 (25.40) I.D.	1.000 (25.40) O.D.	4 dBA
25707N	1.125 (28.58) I.D.	1.125 (28.58) O.D.	4 dBA
25708N	1.250 (31.75) I.D.	1.250 (31.75) O.D.	4 dBA
25709N	1.375 (34.93) I.D.	1.375 (34.93) O.D.	4 dBA
25710N	1.500 (38.10) I.D.	1.500 (38.10) O.D.	4 dBA
25711N	1.625 (41.28) I.D.	1.625 (41.28) O.D.	4 dBA

* "Typical" sound reduction for exhaust noise at full load (WOT). Individual results may vary. Sound reduction depends on total vehicle or equipment and other noise contributions.

Note: Purchaser is responsible for all application verification, endurance and certification testing prior to production release. Exhaust systems may need to be certified as meeting EPA/ CARB emission standards by the engine manufacturer.

Off-Highway Industrial Mufflers

Notes





Section 5: Special Mufflers



Table of Contents

Section 5:	
Special Mufflers.....	5-1
Spark Arresters.....	5-3
Pak Stacks	5-3
Resonators	5-4
Splitter Tee Resonator.....	5-4
Wye Connector Resonator.....	5-4
Stainless Steel Mufflers	5-4



Special Mufflers



Spark Arresters

- Designed for universal application with a minimum of restriction on the engine.
- They work well as add-on units to existing exhaust systems. Their lightweight and small size reduces stress and vibration to the rest of the exhaust system.
- Typical applications include logging and construction equipment, agricultural machinery, over-the-road trucks, airport equipment, forestry and military vehicles.
- All arresters exceed U.S. Forestry requirements, and are qualified and tested for vertical and horizontal installations under the U.S. Forestry Service Standard 5100-1b.
- All inlets are slotted tube connections. Outlets are O.D. tubing.

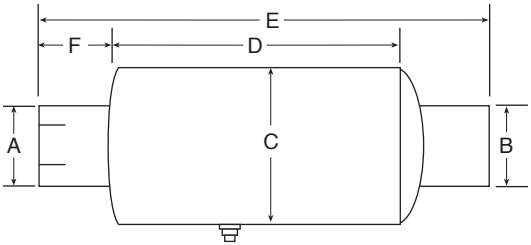

A (O.D.) in (mm)	B (O.D.) in (mm)	C in (mm)	D in (mm)	E in (mm)	F in (mm)	Max. Flow Rate		Part Number
						@ 2" Hg	@ 1" Hg	
1.05 (26.67)	1.25 (31.75)	4.24 (107.70)	3.20 (81.28)	5.90 (149.86)	1.30 (33.02)	88	62	49110U
1.50 (38.10)	1.50 (38.10)	4.24 (107.70)	3.10 (78.74)	5.90 (149.86)	1.40 (35.56)	130	92	49115U
2.00 (50.80)	2.00 (50.80)	5.62 (142.75)	6.40 (162.56)	11.00 (279.40)	2.00 (50.80)	238	168	49120B
2.50 (63.50)	2.63 (66.80)	5.62 (142.75)	8.60 (218.44)	12.80 (325.12)	2.00 (50.80)	420	296	49125A
3.00 (76.20)	3.13 (79.50)	6.62 (168.15)	10.20 (259.08)	14.90 (378.46)	2.50 (63.50)	602	425	49130A
3.50 (88.90)	3.63 (92.20)	7.62 (193.55)	12.00 (304.80)	17.60 (447.04)	3.00 (76.20)	817	576	49135A
4.00 (101.60)	4.13 (104.90)	8.50 (215.90)	14.60 (370.84)	21.20 (538.48)	3.40 (86.36)	1064	751	49140A
5.00 (127.00)	5.13 (130.30)	9.62 (244.35)	16.00 (406.40)	24.00 (609.60)	4.00 (101.60)	1658	1169	49150A
6.00 (152.40)	6.13 (155.70)	12.12 (307.85)	22.00 (558.80)	27.00 (685.80)	2.00 (50.80)	2355	1665	49160A

Pak Stacks

- Can reduce exhaust noise by 3 to 4 dBA
- Mounts directly into existing system, replacing the conventional stack
- Aluminized steel, polished stainless steel or chrome plated



Diameter (O.D.) in (mm)	Length in (mm)	Aluminized Steel Part Number	Polished Stainless Steel Part Number	Chrome Part Number
4.00 (101.60)	35.50 (901.70)	89193U	—	—
5.00 (127.00)	35.50 (901.70)	89194U	—	—
5.00 (127.00)	40.00 (1,016.00)	86582M	—	—
4.00 (101.60)	45.00 (1,143.00)	89195U	89197U	—
5.00 (127.00)	45.00 (1,143.00)	89196U	89198U	—
5.00 (127.00)	60.00 (1,524.00)	—	—	90895U

Special Mufflers

Resonators

- Can reduce exhaust noise by 3 to 6 dBA
- Most effective when installed in exhaust pipe before the muffler



Body Diameter in (mm)	Inlet and Outlet I.D. in (mm)	Body Length in (mm)	Overall Length in (mm)	Part Number
9.00 (228.60)	5.00 (127.00)	11.50 (292.10)	16.25 (412.75)	86145M
9.00 (228.60)	4.00 (101.60)	11.50 (292.10)	16.25 (412.75)	86144M
9.00 (228.60)	3.50 (88.90)	11.50 (292.10)	16.25 (412.75)	86150M
9.00 (228.60)	3.00 (76.20)	11.50 (292.10)	16.00 (406.40)	86556M

Splitter Tee Resonator

- Economical way to convert a single system exhaust into a dual system
- Produces low back pressure with an additional 3-5 dBA of exhaust noise control

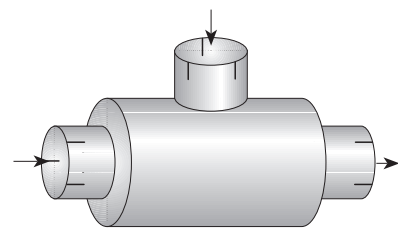

Shell Diameter in (mm)	Shell Length in (mm)	Overall Length in (mm)	Inlet I.D. in (mm)	Outlet I.D. in (mm)	Part Number
7.00 (177.80)	15.00 (381.00)	18.50 (469.90)	3.50 (88.90)	5.00 (127.00)	86300M

Wye Connector Resonator

- Joins left and right hand exhaust pipes
- Provides an additional 3 to 7 dBA exhaust noise reduction over that of the primary muffler

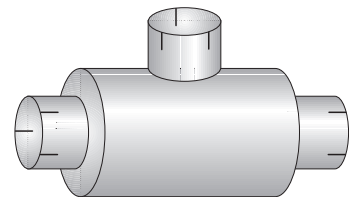

Shell Diameter in (mm)	Shell Length in (mm)	Overall Length in (mm)	Inlet I.D. in (mm)	Outlet I.D. in (mm)	Part Number
10.00 (254.00)	15.00 (381.00)	21.00 (533.40)	5.00 (127.00)	5.00 (127.00)	86305M

Stainless Steel Mufflers

- Bright finish stainless bodies
- Noise and back pressure equal to OE specifications
- Shipped with protective coating on body

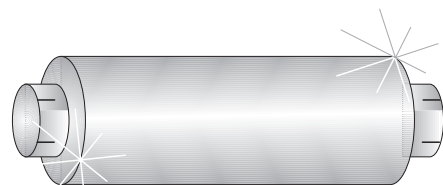

Part Number	Inlet Size (I.D.) in (mm)	Outlet Size (I.D.) in (mm)	Body Diameter in (mm)	Body Length in (mm)	Similar Standard Part Number
86408M	4.00 (101.60)	4.00 (101.60)	9.00 (228.60)	44.50 (1130.30)	86108M
86402M	5.00 (127.00)	5.00 (127.00)	9.00 (228.60)	44.50 (1130.30)	86102M
86430M	5.00 (127.00)	5.00 (127.00)	10.10 (256.54)	44.50 (1130.30)	86130M
86700M*	5.00 (127.00)	5.00 (127.00)	10.20 (259.08)	44.50 (1130.30)	—
86712M*	5.00 (127.00)	5.00 (127.00)	10.20 (259.08)	44.50 (1130.30)	86196M

* Insulated body



Section 6: Exhaust Cross Reference



Table of Contents

Section 6:	
Exhaust Cross Reference	6-1
Cross Reference by Manufacturer	6-3
Cross Reference by Number	6-21
Manufacturer's Abbreviations.....	6-21



Cross Reference by Manufacturer

OEM No.	Our No.	OEM No.	Our No.	OEM No.	Our No.	OEM No.	Our No.	OEM No.	Our No.	OEM No.	Our No.
A M GENERAL™		836310	86168M	3693	49135A	8982	89721K	9415	89780C	9622	89531K
5952263	12036A	840031	86153M	3694	49140A	8983	89722K	9417	89075C	9624	90547K
5987323	86132M	E650006	86131M	3695	49150A	8984	89640K	9427	89744C	14337	89261A
142130S	90364A	E650097	86132M	3696	49160A	8985	89641K	9428	89744C	14338	89263A
143350S	90368A	E650102	86106M	3697	86183M	8986	89642K	9430	89775K	14339	89160A
5932836C	90358A	E650103	86159M	3698	86503M	8987	89643K	9451	89761K	14340	89161A
5932837C	90378A	AMERICAN LAFRANCE™		3699	86130M	8988	89644K	9452	89762K	14341	89162A
MD21020000	18861N	6751378	86125M	3700	86502M	8989	89645K	9453	89763K	14343	89151A
RCSK15040	89513K	AMERICAN & OHIO		3702	86526M	8990	89646K	9457	89771K	14601	89160A
RCSK15127	89512K	LOCOMOTIVE CRANE		3703	86511M	8991	89166A	9458	89774C	14602	89161A
RCSK21289	89503K	COMPANY™		3704	86510M	9299	89995C	9470	89955K	14603	89162A
RCSK212891	89520K	12422	89450E	3705	86597M	9300	89995C	9471	89956K	14605	89163A
RCSK212892	89507K	AP™		3706	86220M	9301	89098A	9475	89959K	14618	89143A
AG CHEM EQUIPMENT®		2701	86164M	3707	86530M	9303	89099A	9476	89960K	14619	89144A
514436	89027A	2704	86139M	3708	86557M	9304	89102A	9477	89971K	14620	90909A
514985	89252A	3607	86164M	3710	86505M	9305	89104A	9478	90569A	14621	89143C
515355	89217A	3608	86164M	3711	86500M	9306	89106A	9486	89548C	14622	89144C
515380	86102M	3610	86185M	3712	86514M	9308	89108A	9487	89549C	14623	90909C
515397	89780A	3611	86512M	3713	86529M	9309	89118A	9490	89566K	24344	89153A
515461	89501K	3614	86125M	3714	86544M	9310	89109A	9492	89568K	24345	89154A
515804	86102M	3616	86159M	3715	86215M	9311	89071A	9493	89569K	24346	90913A
516154	89021A	3618	86150M	3716	86536M	9313	89073A	9495	89570K	24347	89156A
516164	89021A	3620	86147M	3718	86542M	9314	89077A	9498	89996C	24654	89740K
516523	86514M	3621	86178M	3719	86722M	9315	89780A	9499	89995C	24655	89742K
516534	86131M	3622	86190M	8167	90863K	9316	90488A	9500	89995C	24672	89146A
516554	89046A	3623	86191M	8462	89519K	9317	89075A	9501	89956K	24673	89146C
516678	89749C	3625	86127M	8483	89519K	9319	89076A	9502	89557K	24675	89613K
516679	89766K	3626	86192M	8679	89125A	9329	89092A	9503	89558K	24676	89617K
516719	90452A	3627	86119M	8682	89232A	9330	89236A	9504	89559K	24677	89727K
516754	89724K	3629	86119M	8684	89132A	9331	89187A	9506	89560K	24678	89731K
516754	89724P	3632	86153M	8685	89133A	9332	89186A	9518	90470K	24696	89147A
516920	89097A	3634	86206M	8868	89708K	9333	89184A	9530	90465C	24701	89218C
606699	89740K	3636	86193M	8870	89709K	9335	89278A	9532	89111A	24710	89214A
AGCO™		3638	86305M	8872	89710K	9336	89283A	9533	89233A	24711	89216A
858635	89146A	3640	86130M	8875	89712K	9337	89091A	9534	89113A	24712	89218A
2020805	90366B	3645	86194M	8877	89715K	9338	89093A	9535	89114A	24713	89145A
2055366	90368B	3646	86180M	8878	89723K	9339	89095A	9536	89114A	24714	89146A
70229531	05388T	3647	86147M	8879	89724K	9340	89097A	9537	89115A	24715	89145C
70261975	18202T	3651	86186M	8880	89712K	9342	90533A	9538	89925A	24716	89146C
71381507	89923A	3652	86187M	8881	89713K	9343	90538A	9539	89116A	24717	89155A
71381507	89923C	3653	86189M	8882	89714K	9344	90539A	9540	89117A	24718	89156A
72527255	89730K	3654	86137M	8883	89620K	9350	89518K	9541	89123A	24721	89155C
73137579	89450A	3655	86139M	8884	89621K	9355	89535K	9542	89118A	24722	89156C
73137579	89450E	3661	86300M	8885	89622K	9356	89538K	9546	89107C	24731	89211A
303106241	89057C	3663	86135M	8886	89623K	9357	89539K	9553	90459A	24735	89022A
700708242	20680T	3664	86131M	8887	89624K	9358	89540K	9554	89107A	24737	89025A
30641E91	09166T	3666	86108M	8888	89625K	9359	89551K	9555	90460A	24739	89028A
30645E91	14245T	3667	86102M	8895	89626K	9363	90076A	9556	89109A	24745	89052A
30647E91	14490T	3667	86132M	8896	89719K	9365	90079A	9559	89783A	24746	89055A
30654W91	48111U	3668	86213M	8906	89249A	9366	90080A	9560	90465A	24747	89058A
3632067M1	89967K	3669	86168M	8933	89249A	9369	89460A	9561	89081A	24748	89043A
3632150M1	89783A	3670	86133M	8942	89279A	9370	89422A	9562	89082A	24749	89043C
5016230M1	90876A	3671	86200M	8943	89250A	9371	89420A	9564	89083A	24750	89046A
5016231M1	89548K	3673	86200M	8953	89271A	9372	89425A	9565	89087A	24751	89046C
5016231M2	89527K	3674	86115M	8955	89274A	9374	89435A	9566	89782A	24752	89600K
578090M92	14222T	3675	86203M	8956	89275A	9375	89440A	9567	89783A	24753	89603K
ALLIS-CHALMERS™		3677	86151M	8957	89276A	9376	89445A	9568	89086A	24754	89606K
250632	14245T	3678	86149M	8958	89277A	9377	89450A	9573	89440C	24755	89609K
1118626	86177M	3679	86113M	8960	89168A	9378	89427A	9575	89450C	24757	89055C
3061656	86119M	3680	86136M	8962	89170A	9384	89525W	9604	90354A	24758	89058C
3061668	86139M	3681	86144M	8964	89172A	9385	89526W	9605	90355A	24835	89607K
70261975	18202T	3682	86145M	8965	89173A	9386	89527W	9607	90358A	24836	89728K
73121453	49140A	3683	86173M	8971	89246A	9387	89528W	9612	89500K	24849	89604K
AMERICAN HOIST & DERRICK™		3684	86175M	8972	89247A	9392	89958K	9613	89512K	24850	89618K
805335	86175M	3686	86172M	8973	89248A	9393	89966K	9614	89533K	34673	89729K
806237	86125M	3687	20153T	8974	89266A	9394	89961K	9615	89503K	34674	89733K
807002	86172M	3689	86106M	8975	89164A	9395	89505K	9616	89510K	34703	89026C
808164	86180M	3690	49120B	8976	89165A	9396	89506K	9617	89509K	34708	89017C
836309	49140A	3691	49125A	8978	89167A	9399	89507K	9618	89571K	34711	89014A
		3692	49130A	8979	89252A	9406	89106C	9619	89532K	34712	89017A

Cross Reference by Manufacturer

OEM No.	Our No.	OEM No.	Our No.	OEM No.	Our No.	OEM No.	Our No.	OEM No.	Our No.	OEM No.	Our No.
34713	89020A	64745	90570C	A400	89527W	621483A	86135M	BLOUNT™		2118156	929007A
34714	89023A	64746	90905C	A500	89528W	7AN010	86127M	131048	89549K	2119485	929007A
34715	89026A	68182	89887A	AS300	90873A	7GB010	86108M	541565	86144M	2119675	929027A
34716	89029A	68185	89901A	AS350	90874A	850485B	86127M	545002	23426N	2119683	929027A
34717	89050A	68221	926008A	AS400	90875A	BIG RIG™					
34719	89056A	74607	926005A	AS500	90877A	5102	86108M	563109	89545K	2119691	929027A
34720	89059A	74608	89986C	B200	89521K	5103	86132M	565243	89548K	2119709	929027A
34723	89044A	74609	89989C	B212	89523K	5106	86145M	1029948	89550K	2133120	86136M
34724	89047A	74627	926011A	B214	89522K	5108	86113M	10000819	89550K	2199800	86137M
34725	89036C	74632	927010A	B234	89524K	5108	86113M	10002042	86108M	2306635	86136M
34743	89608K	74638	90447C	B300	89525K	5109	86144M	10002139	89923A	2393290	86137M
34744	89611K	74646	926072A	B312	89526K	5110	86127M	10002139	89923C	2434175	86137M
34746	89056C	83000	929016A	B400	89527K	5112	86130M	10002140	89275A	2444889	86137M
34785	89605K	83005	929011A	B500	89528K	5203	86137M	10002433	89101A	2453809	86136M
34786	89619K	83008	929012A	B600	89529K	5206	86168M	10002435	86139M	2488074	86137M
34799	924037A	83009	90579C	BB234	89524K	5302	86125M	10002438	89430E	2646503	929007A
44656	89027A	83014	929001A	BB300	89525B	5401	86133M	10004266	89144A	2704542	929007A
44657	89015A	83016	924005A	BB312	89526K	5720	49120B	10004693	89185A	2941448	86137M
44658	89030A	83028	929027A	BB400	89527B	5725	49125A	10008010	89103A	3693710	86136M
44659	89018A	84548	89987C	BB500	89528B	5730	49130A	10008013	89547K	3724300	86136M
44660	89027C	84550	89990C	H200	90929K	5735	49135A	10008318	89685K	3741399	86136M
44662	89030C	84552	929011A	H212	90916K	5740	49140A	10009552	89670K	3816360	86136M
44664	89057A	84563	90449C	H214	90915K	5750	49150A	10009625	89671K	3816361	86136M
44665	89045A	84569	90448C	H234	89544K	5760	49160A	10009664	89674K	3850422	86136M
44666	89060A	89029	929038A	H238	90916K	BILLINGSLEY™					
44667	89048A	92673	89940A	H258	89544K	CH802F	925002A	10013902	90354A	3850424	86137M
44668	89057C	92674	89950A	H300	89545K	CH802G	929012A	10025725	86200M	3890258	86136M
44669	89045C	92679	89941A	H312	89547K	FD275F72	929005A	10029077	89675K	3890340	86136M
44670	89060C	92689	89951A	H314	89546K	FD275R72	929005A	10031706	89543K	3904077	86137M
44725	89021C	94902	90450C	H400	89548K	FD3208F	925005A	10033083	89113A	3928084	86137M
44726	89029C	925502	89963K	H412	90092A	FD3208F	925005A	10033566	89698K	3930268	86136M
44731	89024A	926002	89664K	H500	89549K	FD400F72	929007A	10051093	89525K	3941446	86136M
44732	89051A	928002	89666K	H600	89550K	FD660C	926011A	10051128	89512K	3941447	86137M
44734	89051C	02-7076561	89527W	T112	90927K	FD660EXT	924004A	P04435300	86108M	3941457	86137M
44735	89054C	02-7076562	89528W	T134	90928K	FD660F	929027A	BLUEBIRD BUS™			
44737	89037C	200A1016	929002A	T158	90928K	FD660R	929027A	377424	86133M	3954017	86137M
44773	924027A	200A7516	929002A	T178	90914K	FD660R	9230008A	693298	86137M	3954019	86137M
48348	923008A	200K1014	929013K	T200	89541K	FDEX780	923008A	693299	86164M	3954021	86137M
48349	924004A	200K1016	89670K	T212	89543K	IH3208F	926005A	724859	86164M	15638767	86722M
54713	89217C	200K7016	929002A	T214	89542K	IH3208F	929011A	796790	86164M	2201005578	90352A
54714	89031C	200K7514	929002A	T234	89544K	IH360A	925005A	815613	86108M	2201124783	90354A
54716	89019C	200K7516	929002A	T300	89545K	M234	86164M	815613	86630M	2811005560	90355A
54717	89205A	212A1014	929004A	T312	89547K	M300	86139M	993915	90868A	2811250299	89560K
54718	89019A	212A1016	929004A	T314	89546K	M3208	86185M	997791	89513K	2811250851	90358A
54720	89031A	212K1014	929014K	T400	89548K	M3661	86557M	1005321	924004A	119144H	86139M
54721	89226A	212K7514	929004A	T500	89549K	M370	86183M	1046473	89942A	119144H	86139M
54722	89227A	214A1014	929003A	T600	89550K	M392	86184M	1111863	89623K	2811005552B	90376A
54723	89226C	214A7514	929003A	U112	90927K	M404	86185M	1250844	86132M	BRIGGS & STRATTON®	
54724	89227C	214K1014	929003A	U134	90928K	M466	86512M	1267939	86168M	290933	48111U
54725	89222A	214K7014	929003A	U158	90928K	M466	86512M	1289040	86557M	299477	48111U
54726	89049A	214K7514	929003A	U178	90914K	M466	86512M	1332386	924005A	390247	48111U
54727	89222C	234A1014	929024A	U200	90929K	M600	86529M	1334226	89571K	391221	48111U
54736	89215A	234A1016	929024A	U212	90916K	M800N	86502M	1338128	89622K	BROCKWAY™	
54745	89221C	234A1414	929005A	U214	90915K	M800T	86502M	1357342	924037A	252063	90365A
54809	925002A	234C1016	90615K	ATHEY™		M800T	86502M	1357359	924037A	409132	86127M
54827	90451A	300A1014	929025A	67362	49140A	M900	86185M	1394592	86196M	409885	86108M
54828	90451C	300A1016	89685K	P1003953	89430E	TB40010	929007A	1394600	86145M	510118	86102M
54829	90452A	300K1014	929015K	P70638	86106M	BLAW-KNOX™					
54830	90452C	312A1016	89686K	ATLAS™						1410133	924037A
54844	90444A	312K1014	929026A	1310031081	Q186201	164577	89545K	1436146	86195M	512736	86125M
54880	924037A	400A1014	929027A	1310032059	90361A	164579	89021A	1436161	86195M	516140	86131M
54881	90568C	400A1016	89687K	1310034562	89182A	164586	89548K	1466929	89145A	521450	86102M
58225	926062A	400A1414	929007A	1310038237	89435E	164590	89547K	14668099	86108M	524430	86685M
58251	925014A	400C1016	89674K	AUTOCAR™						1468099	86108M
58285	925005A	500A1016	89688K	70147	86300M	164634	89542K	1477538	923042A	528905	86108M
58319	924004A	500C1016	89675K	291772	86131M	164653	89164A	1477629	924005A	541362	86200M
58330	924008A	600A1016	89698K	619077	86135M	164711	89541K	1477637	924005A	543851	90354A
64671	89985A	600C1016	89676K	643984	86135M	164713	89519K	1477645	924005A	2ME335	86127M
64672	89988C	A300	89525W	31100390	86300M	164784	89098A	1477645	924005A	2ME338	86127M
64673	89985C	A312	89526W	619077A	86135M	164784	89101A	1522291	86130M	BUCYRUS-ERIE®	
						164785	89101A	1569318	89790K	17279	86177M
						164786	89105A	1569326	89550K	46652000	86131M
						16457900	89021A	1569425	86610M	46653350	86125M
						16478500	89101A	1575836	86543M	46664250	86172M
								1997964	86547M	46665250	86173M

Cross Reference by Manufacturer

OEM No.	Our No.	OEM No.	Our No.	OEM No.	Our No.	OEM No.	Our No.	OEM No.	Our No.	OEM No.	Our No.		
46665796	86102M	L09379	86147M	1513792	86168M	21081	86300M	2008449C1	89450E	11129	86206M		
46665797	86175M	L09381	86125M	1514083	86119M	21083	86203M	DODGE™			11136	86193M	
46665799	86145M	L101421	17123N	1517514	49160A	21090	86195M				1566204	86136M	11142
CABOT™													
911753	86180M	L104036	Q25344	1517515	49150A	21093	86195M	1920677	86135M	11145	86118M		
911778	86175M	L110478	49130A	1517516	86180M	21094	86194M	1934041	86127M	11159	86305M		
911784	86173M	L13782	86150M	1518825	86115M	210126	86116M	1934042	86127M	11165	86195M		
CARRIER™													
300043300	90928K	R27575	12385T	1519325	86102M	550098	89762K	2227915	86136M	11167	86130M		
64RT500138	89541K	R41889	16730T	1543567	86147M	2100123	86108M	2229617	86136M	11169	86130M		
64RT500153	89519K	ZNL22705T	22705T	1550817	86172M	2100134	86531M	2229768	86127M	11179	86115M		
CASE™													
103978C2	15088T	ZNL645633	Q645633	1796899	86213M	2100148	86514M	2229769	86135M	11191	86194M		
106337C4	14490T	ZNL90873A	90873A	1902490	49135A	8A5098	86139M	2460823	86136M	11197	86180M		
131108C1	13900T	CATERPILLAR®											
143660C1	17120T	686607	89420A	2321070	86137M	A4957	86139M	2505995	86133M	11204	86203M		
144057C5	17275T	686607	89420A	2501710	86213M	CUB CADET®							
190981A1	90873A	773905	86159M	2501803	86159M	351436R92	16487T	2508346	86136M	11222	86130M		
198766A1	49130A	817066	86130M	2510883	86206M	385307R1	4790M	2550929	86125M	11224	86130M		
350601R95	14245T	870373	89926A	2521781	49135A	385308R1	48111U	2555240	86127M	12000	49115U		
351436R92	16487T	870377	89924A	2531697	86153M	393808R1	14472T	2831025	86108M	12001	49115U		
357288R92	14245T	870383	89058A	2557506	86116M	IH393840R91	14472T	2907822	86168M	12002	49120B		
357875A1	90877A	870504	89771K	2774082	89519K	CUMMINS®							
359696A1	90875A	980263	89440A	2774995	89021A	16001	89435E	2971502	86115M	12004	49130A		
370644R92	14245T	980263	89440E	2775014	89525K	156815	86108M	2975915	86139M	12005	49135A		
370773R91	14245T	980845	89435E	2775015	89613K	157082	86125M	3459884	86139M	12006	49140A		
376352R91	14245T	1068102	86191M	2776570	49120B	211197	86108M	3634560	86108M	12007	49150A		
384345R91	10156T	1097987	90352A	2786446	89522K	211206	86133M	3638397	86102M	12008	49160A		
384346R91	14245T	1097987	90352B	2793205	49130A	211212	86144M	3820392	86108M	421373	89963K		
393840R91	14472T	1121729	49125A	2812167	89541K	211213	86145M	3821787	86136M	H234	89544K		
398511R1	10156T	1177300	89543K	2817356	89545K	212362	86139M	3828126	86102M	H238	90916K		
403551R1	14245T	1326196	89541K	2817357	90869A	251210	86145M	9505995	86133M	H300	89545K		
403825R1	10811T	1326476	89541K	2818526	49125A	251211	86132M	38228126	86102M	H312	89547K		
413363A1	90366B	1343136	89460A	2821257	89571K	1100279	86139M	DOMINION®			H314	89546K	
530578R4	11650T	2055371	90885A	2907822	86168M	3917656	89430E	4450	86150M	H400	89548K		
530588R4	11651T	1G5679	89547K	3657316	89614K	3917673	89440E	6973	86175M	H500	89549K		
534545R4	11731T	28N92	89168A	5292627	86159M	3917826	89545K	10253	49140A	H600	89550K		
534546R6	17704T	3B6212	40849T	6002355	86168M	5100006	89685K	11876	86106M	J000110	929002A		
829176C91	14099T	3B7942	49130A	62785030	86144M	10000137	89164A	DONALDSON®					
829640C91	13994T	3B7964	49140A	161WA533	86139M	10000139	25582N	11001	86164M	J000121	929003A		
829640C92	13994T	3E6637	89772K	931SA0393	86125M	10000171	25922N	11002	86136M	J000126	929024A		
907636T1	90358C	3K3124	20153T	931SA185	86125M	10000176	89166A	11004	86137M	J000127	929024A		
907636T1	90358C	3R0682	86139M	931SB0393	86145M	10000201	89211A	11014	86300M	J000128	929005A		
A062880	89547K	7S8443	20620T	CMI CORP.™				11015	86139M	J000129	90615K		
A139471	14663T	8C2246	89059A	42728	86153M	10000321	Q186112	11016	86135M	J000130	929025A		
A142751	22705T	8S2809	20154T	4003012	86180M	DAEWOO™							
A147044	22152T	9F6433	86125M	COCKSHUTT™				D418219	89543K	11019	86119M		
A147100	15572T	9N8199	89168A	164080A	10156T	DAVEY™							
A15163	22706T	9S9328	20619T	TG07530	14245T	86396	89422A	11020	86131M	11020	86131M		
A172152	Q42088	L9381	86125M	CONSOLIDATED DIESEL™				A40801	86175M	11022	86108M		
A172785	20332A	L9397	86147M	23460286	89440E	DETROIT DIESEL®							
A173180	20680T	CEDARAPIDS™											
A180204	Q42089	4571000318	90562A	CONTINENTAL™				5127284	89542K	11025	86113M		
A184157	21326A	422032	86133M	E650097	86102M	DEUTZ®							
A189374	89430E	422032	86133M	5540	90368A	300902	89543K	11036	86125M	11036	86125M		
A19563	86173M	CHAMPION™	86133M	5545	90364A	70237290	14245T	11037	86147M	11037	86147M		
A21464	86178M	CHICAGO-PNEUMATIC™	86131M	5546	90365A	71362829	89187A	11074	86177M	11074	86177M		
A23476	86178M	1PS0848	86131M	5546	90365A	71362830	89277A	11076	86178M	11076	86178M		
A24314	86178M	1PS4174	86136M	21013	86108M	DIAMOND RIO™							
A39022	11396T	3PS4174	86115M	21016	86150M	623L1	86131M	11080	86190M	11080	86190M		
A39561	11669T	4PS4174	86125M	21018	86125M	700768L2	49140A	11081	86191M	11081	86191M		
A42229	49125A	5PS4174	86147M	21018	86125M	858630L2	86144M	11084	86173M	11084	86173M		
A56029	86150M	6PS4174	86102M	21023	86139M	858791L1	86144M	11085	86150M	11085	86150M		
A64990	11026T	P1906	86175M	21026	86133M	880L1	86132M	11096	86127M	11096	86127M		
A66780	22150T	P2035	86173M	21030	86133M	889L1	86127M	11102	86192M	11102	86192M		
D45256	49125A	P20352	86139M	21035	86108M	992L1	86108M	11107	86119M	11107	86119M		
D64008	13909T	252178	49135A	21066	86133M	992L11	86102M	11109	86144M	11109	86144M		
F18685	86177M	427170	86175M	21066	86133M	992L12	86108M	11112	86175M	11112	86175M		
G45239	11396T	501803	86159M	21067	86200M	N21470A	86131M	11119	86108M	11119	86108M		
G45264	11396T	507064	86173M	21070	86102M	DINA™							
		532603	86150M	21072	86203M	110B070240	90378B	11126	86159M	11126	86159M		
		545546	86132M	21078	86130M	110B070250	90358B	11127	86213M	11127	86213M		
		1505943	86139M										
		1512238	86133M										

Cross Reference by Manufacturer

OEM No.	Our No.	OEM No.	Our No.	OEM No.	Our No.	OEM No.	Our No.	OEM No.	Our No.	OEM No.	Our No.
J008896	89719K	J024751	89046C	J190063	90369A	M085182	86135M	M110014	86672M	P206337	89688K
J008897	89620K	J024752	89600K	J190072	89759K	M085189	86184M	M110015	86501M	P206338	89698K
J008942	89279A	J024753	89603K	J190073	89772K	M085206	86192M	M110016	86221M	P206339	900048A
J008943	89250A	J024754	89606K	J240003	89612K	M085267	86722M	M110028	86529M	P206340	89101A
J008982	89721K	J024755	89609K	J240004	89614K	M085308	86522M	M110077	86705M	P206341	89102A
J008983	89722K	J024757	89055C	J240005	89616K	M085407	201560N	M110189	86529M	P206342	89103A
J009298	89748A	J024758	89058C	J240007	89730K	M085408	201561N	M110479	86724M	P206343	89104A
J009299	89995C	J024835	89607K	J240008	89005C	M085409	201562N	M110480	86724M	P206344	89105A
J009300	89995C	J024836	89728K	J240014	89016A	M085410	201563N	M110481	86727M	P206345	89106A
J009301	89098A	J024837	89314K	J240016	89035C	M085411	201564N	M110482	86756M	P206346	900059A
J009309	89118A	J024838	89723K	J280003	89889A	M090009	86175M	M110483	86725M	P206347	89107A
J009316	90488A	J024849	89604K	J340005	89615K	M090072	86145M	M120100	86125M	P206348	89108A
J009317	900065A	J024850	89618K	J340021	89020C	M090074	86132M	M120108	86147M	P206349	89118A
J009393	89966K	J028528	89897A	J340022	89023C	M090091	49150A	M120154	86115M	P206350	89109A
J009399	89507K	J028532	90983A	J340023	89029C	M090146	86113M	M120197	86752M	P206353	89106C
J009427	89744C	J034673	89729K	J380001	89882A	M090158	86106M	M120210	86221M	P206363	89246A
J009428	89744C	J034674	89733K	J380002	89892A	M090210	86206M	M120225	86147M	P206364	89247A
J009429	89748A	J034703	89026C	J380003	90967A	M090280	86153M	M120235	86194M	P206365	89248A
J009498	89996K	J034725	89036C	J480001	89893A	M090295	86597M	M120366	86503M	P206366	89250A
J009499	89995C	J034743	89608K	J540008	90438C	M090301	86193M	M120367	86608M	P206367	89164A
J009500	89994C	J034744	89611K	J640001	89916A	M090362	86144M	M120382	86149M	P206368	89165A
J009518	90470K	J034746	89053C	J640005	89293K	M090388	86148M	M120566	86542M	P206369	89166A
J009530	90465C	J034785	89605K	J640007	89296C	M090391	20620T	M120592	86753M	P206370	89167A
J009539	89116A	J034786	89619K	J640008	89296A	M090520	86512M	M120747	201575N	P206371	89263A
J009547	89784C	J038603	90922A	J640009	90589C	M090534	86153M	M120748	201576N	P206372	89160A
J009548	89105C	J038608	90823A	J640012	89920A	M090535	86739M	M120749	201577N	P206373	89161A
J009560	90465A	J038611	90980A	J640013	89920C	M090544	86108M	M120750	201578N	P206374	89162A
J009565	900068A	J038612	90979A	M001327	89194U	M090545	86514M	M120751	201579N	P206375	89163A
J009604	90354A	J054743	900088C	M001338	89193U	M090547	86537M	M122300	86180M	P206378	89015A
J009605	90355A	J054745	89221C	M045123	89110U	M090548	86545M	P205834	89775K	P206379	89018A
J009607	89500K	J068182	89887A	M045237	89177M	M090563	86185M	P205976	90538A	P206380	89037A
J009612	89500K	J068185	89901A	M060005	86172M	M090594	86560M	P206280	89073A	P206381	89042A
J009613	89512K	J074608	89986C	M060037	49120B	M090595	200238N	P206281	89077A	P206382	89045A
J009614	89502K	J092679	89941A	M060038	49115U	M090596	86139M	P206282	900064A	P206383	89048A
J009617	89509K	J092689	89951A	M060055	86136M	M090680	86536M	P206283	89075A	P206384	89155C
J009619	89532K	J094941	90993A	M060158	86190M	M090680	86536M	P206284	89076A	P206385	89156C
J009620	89105A	J094942	90981A	M060232	86136M	M090781	86514M	P206285	89780C	P206386	89045C
J009621	89105C	J190002	90463A	M060249	86190M	M090781	86514M	P206286	89781C	P206391	89019C
J009624	90368A	J190003	89924A	M060479	201550N	M091046	201565N	P206297	89940A	P206393	89130A
J009632	900073A	J190004	89924C	M060480	201551N	M091047	201566N	P206298	89950A	P206394	89131A
J009633	900074A	J190009	89124A	M060481	201552N	M091048	201567N	P206300	90539A	P206395	89132A
J009636	900077A	J190011	89123A	M060482	201553N	M091049	201568N	P206301	89141A	P206396	89133A
J009637	900078A	J190013	89234A	M060483	201554N	M091050	201569N	P206302	89143A	P206397	89091A
J009640	900081A	J190014	89235A	M065030	49125A	M100016	49160A	P206304	90909A	P206398	89093A
J009641	900082A	J190016	89115C	M065034	86137M	M100043	86118M	P206305	89146A	P206399	89095A
J009644	900085A	J190017	89125A	M065042	86137M	M100048	86168M	P206306	89150A	P206400	89097A
J009645	900086A	J190019	89117C	M065044	86191M	M100049	86133M	P206308	89151A	P206403	89541K
J009647	89530K	J190020	89127A	M065065	86137M	M100052	86151M	P206309	89153A	P206404	89542K
J009648	89881A	J190023	89074A	M065071	86178M	M100058	86305M	P206310	89154A	P206405	89543K
J009649	89256A	J190024	89074C	M065072	86191M	M100104	86215M	P206311	90913A	P206406	89544K
J009650	89883A	J190026	89781C	M065138	201555N	M100213	86526M	P206313	89271A	P206407	89519K
J014337	89261A	J190027	89075A	M065139	201556N	M100463	86130M	P206314	89274A	P206407	89519K
J014338	89263A	J190028	89075C	M065140	201557N	M100464	86200M	P206315	89275A	P206408	89546K
J014339	89160A	J190032	89076A	M065141	201558N	M100465	86682M	P206316	89276A	P206409	89547K
J014340	89161A	J190035	89086A	M065142	201559N	M100466	86544M	P206317	89277A	P206410	89548K
J014341	89162A	J190042	89253A	M070008	86173M	M100580	86531M	P206318	89278A	P206411	89549K
J014623	90909C	J190044	89254A	M070028	86150M	M100582	86196M	P206319	89168A	P206509	89771K
J018109	90938A	J190045	89255A	M070066	49135A	M100585	86531M	P206320	89170A	P206510	89761K
J024657	89740K	J190046	90560A	M070094	86300M	M100695	86547M	P206322	89172A	P206511	89762K
J024658	89742K	J190049	89282A	M070185	86164M	M100740	86533M	P206323	89173A	P206512	89763K
J024673	89218C	J190050	90350A	M080018	20153T	M100741	86196M	P206324	89182A	P206513	89763K
J024731	89211A	J190052	90352A	M080024	49140A	M100807	86626M	P206325	89184A	P206516	89535K
J024735	89022A	J190053	90353A	M085023	86139M	M100815	86788M	P206326	89185A	P206517	89538K
J024737	89025A	J190054	90357A	M085056	86119M	M100845	86544M	P206327	89186A	P206518	89539K
J024739	89028A	J190055	90359A	M085078	86119M	M101167	201570N	P206328	89187A	P206519	89540K
J024746	89055A	J190057	90361A	M085080	86119M	M101168	201571N	P206331	929002A	P206520	89537K
J024747	89058A	J190059	90363A	M085084	86192M	M101169	201572N	P206333	929004A	P206521	89551K
J024748	89043A	J190060	90364A	M085090	86192M	M101170	201573N	P206334	89685K	P206523	90076A
J024749	89043C	J190061	90365A	M085171	86127M	M101171	201574N	P206335	89686K	P206525	90079A
J024750	89046A	J190062	90367A	M085172	86183M	M110012	86500M	P206336	89687K	P206526	90080A

Cross Reference by Manufacturer

OEM No.	Our No.	OEM No.	Our No.	OEM No.	Our No.	OEM No.	Our No.	OEM No.	Our No.	OEM No.	Our No.
P206539	89748A	P207321	89060C	P208342	89041A	P216242	90451C	508699	86159M	1034713	89420A
P206541	89748A	P207322	89110A	P208348	89023A	P216243	90452C	DYNAFLEX®		1034730	89110A
P206543	89744C	P207324	89111A	P208350	89053A	P216248	89508K	86200	49120B	1038482	89549K
P206546	89740K	P207325	89233A	P208356	89014A	P216249	89509K	86250	49125A	1042053	89114A
P206547	89742K	P207326	89113A	P208358	89044A	P216250	89532K	86300	49130A	1042956	89728K
P206552	89613K	P207328	89114A	P208364	89026A	P216252	89501K	86350	49135A	1043371	90443A
P206553	89617K	P207329	89115A	P208366	89056A	P216253	89531K	86400	49140A	1043683	89527K
P206554	89727K	P207330	89925A	P208372	89017A	P216261	89225C	86500	49150A	1046126	89544K
P206555	89731K	P207331	89117A	P208373	89017C	P224586	89221A	87200136	86136M	1046508	90552A
P206557	89729K	P207332	900061A	P208374	89047A	P224625	89225A	87200177	86177M	1048015	89542K
P206558	89733K	P207333	89098A	P208380	89029A	P226147	89625K	87250186	86186M	1051411	89543K
P206560	89642K	P207338	90459A	P208382	89059A	P226156	89723K	87300119	86119M	1056805	90873A
P206561	89643K	P207339	89784A	P208386	89155A	P226158	89724K	87300187	86187M	1056876	89095A
P206562	89644K	P207340	90460A	P208387	89205A	P270531	89417A	87350113	86113M	1056877	89965K
P206563	89645K	P207341	900057A	P208388	89222A	P270532	89420A	87400108	86108M	1058863	89125A
P206564	89622K	P207345	89105C	P208389	89222C	P270533	89422A	87400120	86108M	1062109	89113A
P206565	89623K	P207346	89107C	P208392	89156A	P270534	89425A	87400127	86127M	9307658	89440A
P206566	89524K	P207347	89081A	P208393	89019A	P270535	89427A	87400131	86131M	9307658	89440E
P206567	89625K	P207349	89082A	P208394	89049A	P270538	89435A	87500102	86102M	AY2582	86139M
P206600	89556K	P207350	89242A	P209910	89990C	P270539	89440A	87500130	86130M	BX0376	86119M
P206601	89557K	P207350	89242A	P209911	89987C	P270540	89445A	87500132	86132M	X1034634	89640K
P206602	89558K	P207351	89083A	P209912	89989C	P270541	89450A	87500145	86145M	X1034730	89110A
P206603	89559K	P207352	89087A	P209913	89295C	P270543	89460A	88400133	86133M	EMERGENCY ONE™	
P206604	89505K	P207353	89782A	P209914	90608C	P270837	89440C	89250137	86137M	549803	89950C
P206605	89506K	P207354	900069A	P209916	89918C	P270838	89450C	89300139	86139M	ENTWISTLE™	
P206606	89513K	P207356	89071A	P209919	89916C	P271511	89460C	89350106	86106M	9130B3019017	90892K
P206607	89503K	P207361	89236A	P210110	89510K	P306303	89144A	89400054	86153M	9310B3019005	89440E
P206608	89566K	P207362	89090A	P211449	89760K	X004478	89525W	89400125	86125M	9310B3019007	89923C
P206610	89568K	P207363	89092A	P211450	89773K	X004480	89526W	89400153	86153M	9310B3019011	89674K
P206611	89569K	P207364	89094A	P211613	90191K	X004482	89527W,	874050514	86740M	9310B3020015	89671K
P206613	89531K	P207365	89096A	P211614	90206K		900274A	88H400148	86148M	9310B3020017	89672K
P206615	89967K	P207366	89236A	P211616	89294C		(Upgrade)	DYNAPAC™		9310C3105001	89430E
P206641	89775K	P207367	89661K	P212346	89309K	X004484	89528W,	814261	89544K	9314A094170	89673K
P206849	89662K	P207368	89663K	P212347	89313K		900273A	900201	89440A	9314C094105	89430E
P206850	89664K	P207372	89641K	P213191	89514K		(Upgrade)	900201	89440E	ENUMCLAW™	
P206851	89665K	P207374	89646K	P216165	89073A	X004962	90464K	921097	89547K	19716	49135A
P206926	929024A	P207377	89621K	P216168	89240A	X005164	90365A	921150	89543K	30855	49140A
P206927	89142A	P207379	89626K	P216173	89109C	X005207	90555C	921170	89548K	ERICKSON™	
P207281	89214A	P207402	89283A	P216174	89231A	X005266	90363A	929087	89786K	34110	49120B
P207282	89216A	P207405	89261A	P216175	89119A	X005833	90368A			34112	86177M
P207283	89218A	P207408	89266A	P216176	900057A	X005834	90546K	617211	89547K	FAIRMONT RAILWAY MOTORS™	
P207285	89021A	P207411	89249A	P216179	89006C	X005835	90547K	EATON YALE & TOWNE™		F012611	86136M
P207286	89024A	P207413	89251A	P216182	900090C	X005921	90364A	2033626	86173M	F19008	86206M
P207287	89027A	P207414	89252A	P216186	89228C	X005985	90357A	2042783	86150M	F40070	49160A
P207288	89217A	P207415	89140A	P216188	90570C	X006202	90358A	2072019	86147M	N024782	49120B
P207289	89031A	P207419	89157A	P216191	89212A	X006204	90355A	2076550	86139M	FARMHAND™	
P207290	89226A	P207559	89147A	P216192	89213A	X006212	90358A	2089643	49130A	1D22101	86177M
P207291	89227A	P207566	89961K	P216193	89215A	X007057	90369A	2092903	49135A	FATE ROOT HEATH™	
P207292	89030A	P207567	89959K	P216196	89219A	X007785	90368A	2093622	86119M	VP0644	86175M
P207293	89051A	P207569	89956K	P216200	89053C	X007805	90358A	2095002	86106M	VP0673	86173M
P207294	89054A	P207581	89958K	P216201	89985A	X007830	90364A	5157178	86136M	VP20093	86115M
P207295	89057A	P207584	89971K	P216202	89985C	X007831	90365A	8108216	86148M	VP20096	86203M
P207296	89060A	P207596	89560K	P216205	89988C	X007832	90352A	750838800	49115U	FIAT-ALLIS™	
P207297	89145A	P207598	89570K	P216206	89223A	X007833	90354A	750839800	49120B	73061656	86119M
P207298	89146A	P207619	89955K	P216207	89224A	X007834	90355A			73061668	86139M
P207299	89217C	P207620	89960K	P216208	89223C			DRIL TECH™		FIELD QUEEN™	
P207300	89031K	P207667	89550K	P216209	89224C	1487	86180M	ELGIN SWEEPER™		73331	86108M
P207301	89226C	P207707	89511K	P216210	90447C			EIMCO™		FINN™	
P207302	89227C	P207784	89519K	P216211	90449C	97470	86115M	1017391	86119M	12506	86106M
P207306	89218C	P208315	89713K	P216212	90450C	208852	86150M	1017515	89546K	12526	89154A
P207308	89145C	P208316	89714K	P216213	90443A	220817	86139M	1026315	89430E	23506	86192M
P207309	89146C	P208317	89723K	P216214	90444A	221322	86106M	1026437	89614K	FW75168	89883A
P207312	89037C	P208318	89715K	P216227	89993C	221499	86133M	1026439	89164A	FW75169	89123A
P207314	89021C	P208319	89724K	P216228	89994C	221694	86136M	1030036	89545K	FW75170	86180M
P207316	89027C	P208324	89020A	P216232	90595C	222578	86115M	1030039	89525K	FLXIBLE™	
P207317	89030C	P208326	89050A	P216237	90439C	224620	86206M	1030040	89613K	112352	86125M
P207318	89051C	P208330	89035A	P216238	90440C	230848	86136M	1030624	86213M	87113800001	86147M
P207319	89054C	P208332	89006A	P216239	90442C	231674	86193M	1032027	89440A		
P207320	89057C	P208334	89036A	P216240	90451A	505881	86168M	1032027	89440E		
		P208338	89040A	P216241	90452A	508420	86106M	1032173	89083A		
								1034636	89541K		

Cross Reference by Manufacturer

OEM No.	Our No.	OEM No.	Our No.	OEM No.	Our No.	OEM No.	Our No.	OEM No.	Our No.	OEM No.	Our No.
FMC™											
2081801	86159M	C6TZ5230F	86131M	D7HT5225BTA	86213M	E2HT5225AG2A	86502M	E8HT5225AEA	86535M	A0411717	86195M
2260801	86177M	C6TZ5230G	86136M	D7HT5225CLA	86130M	E2HT5225AGA	86502M	E8HT5225ALA	86626M	A0411717	86195M
2269681	86136M	C6TZ5230H	86136M	D7HT5230BEA	86130M	E2HT5225AZB	86503M	E8HT5225AMA	86626M	A0411840	86130M
2672155	86137M	C6UZ5230C	86136M	D7HT5230FRA	86130M	E2HT5225BCA	86130M	E8HT5225B2A	86698M	A0411843	86130M
2672158	86139M	C7TZ5230A	86168M	D7HT5230FYA	86195M	E2HT5225BE2A	86501M	E8HT5225C2A	86697M	A0412094	86130M
2672159	86168M	C7TZ5230D	86136M	D7HT5230GEA	86130M	E2HT5225BE2A	86501M	E8HT5225G2A	86530M	A0412096000	90358A
2672160	86131M	C7TZ5230E	86136M	D8HS5225CA	86200M	E2HT5225BFA	86195M	E8HT5225K2A	86503M	A0412096004	90365A
2679303	86132M	C7TZ5230F	86137M	D8HS5225EA	86195M	E2HT5225BGA	86130M	E8HT5225KA	86503M	A0412270	86195M
5198957	49130A	C7TZ5230G	86137M	D8HT5230BA	86130M	E2HT5225BHA	86200M	E8HT5225L2A1	86626M	A0412556	86130M
52795491	89115A	C7TZ5230J	86137M	D8HT5230CA	86130M	E2HT5225BIA	86195M	E8HT5225N2A	86626M	A0412966	86130M
12H20	86173M	C7TZ5230K	86136M	D8HZ5246M	86195M	E2HT5225BLA	86130M	E8HT5225R2A	86196M	A0412967	86130M
16H43	86177M	C7TZ5230M	86137M	D8HZ5230AB	86195M	E2HT5225BMA	86130M	E8HT5225SA	86196M	A0413975	86531M
18A2313S	86300M	C8HS5230A	86685M	D8HZ5230AC	86669M	E2HT5225BNA	86503M	E8HZ5230A	86196M	A0414075	86531M
18A2316S	86147M	C8HS5230B	86685M	D8HZ5230AE	86215M	E2HT5225CA	86220M	E8HZ5230AA	86535M	A049981	86108M
18A3784	86147M	C8HS5230G	86147M	D8HZ5230AF	86130M	E2HT5225K2A	86220M	E8HZ5230AE	86626M	A049982	86108M
18H0419	86125M	C8HS5230H	86132M	D8HZ5230AT	86130M	E2HT5225L	86130M	E8HZ5230AF	86626M	A049984	86108M
28H448	49135A	C8HZ5230C	86153M	D8HZ5230AV	86195M	E2HT5225SB	86200M	E8HZ5230B	86196M	A049990	86102M
32H511	86203M	C8TZ5230B	86137M	D8HZ5230AV	86195M	E2HT5225SB	86200M	E8HZ5230B	86196M	A049990	86102M
45A0154X	86106M	C8TZ5230C	86153M	D8HZ5230B	86130M	E2HT5230ANA	86183M	E8HZ5230D	86503M	A049995	86102M
45A1238	86148M	C8TZ5230C	86153M	D8HZ5230F	86130M	E2HT5230BA	86184M	E8HZ5230E	86697M	A049996	86102M
47A0978	86193M	C8UZ5230B	86136M	D8HZ5246M	90938A	E2HZ5230L	86130M	E8HZ5230F	86698M	E8HZ5230AE	86626M
59A2074	86148M	C9HA5225A	86173M	D8HZ5246M	90938A	E2HZ5230N	86220M	E8HZ5230G	86626M	E8HZ5230D	86503M
62W6483	89144A	C9TZ5230A	86136M	D8TZ5230AC	86152M	E2HZ5230R	86183M	E8HZ5230L	86530M	F1HS5225FA	24050A
8A4282	86131M	DOHA5225AE	86115M	D8TZ5230CF	86137M	E2HZ5230S	86183M	E8HZ5230R	86529M	NMC86116M	86116M
8A5566A	49140A	DOHA5225L	86213M	D8TZ5230CF	86137M	E2HZ5230S	86183M	E8HZ5230R	86529M	MTM110078	86705M
8A5810	86203M	DOHA5230J	86108M	D8TZ5230D	86675M	E2HZ5230T	86544M	E8HZ5230T	86529M	NMC22867A	86533M
9H47	86125M	DOHT5225CLA	86130M	D8TZ5230D	86675M	E2HZ5230Y	86544M	E8HZ5230T	86529M	NMC22867A	86533M
9H554	86213M	D8TZ5230W	86213M	D8TZ5230E	86675M	E2HZ5230Z	86650M	E8HZ5230U	86529M	NMC24051A	24051A
AH6019	86213M	D8TZ5230Y	86213M	D9HS5225JA	86200M	E2HZ5230A	86510M	E8HZ5230V	86529M	NMC86130M	86130M
HC2738	49135A	D9HS5225JA	86113M	D9HT51210DA	89530K	E2HZ5A231A	89531K	E8HZ5A231E	89531K	NMC86503M	86503M
HT739	86175M	D9HZ5230A	86115M	D9HZ5230A	86183M	E2HZ5A231A	89531K	E8TZ5230A	86675M	NMC86535M	86653M
IH2180	86106M	D9HZ5230B	86183M	D9HZ5230A	86183M	E3HS5225BA	86501M	E9HZ5230A	86522M	NMC86626M	86626M
IH859	86173M	D9HZ5230B	86183M	D9HZ5230A	86183M	E3HT5225A	86108M	EOHZ5230A	86153M	NMC86630M	86630M
FORD™											
20Q5230D	86137M	D1HS5225AA	86300M	D9HZ5230B	86183M	E3HT5225FB	86221M	EOHZ5230A	86153M	NMC86655M	86655M
7EQ5230	86137M	D2HA5230AA	86108M	D9HZ5230B	86183M	E3HT5225FA	86200M	EOHZ5230A	86153M	NMC86672M	86672M
7HC5230D	86136M	D2HS5230KA	86106M	D9TZ5230G	929005A	E3HT5225SA	86220M	EOHZ5230B	86153M	NMC86682M	86682M
958116487T	16487T	D2HZ5230A	86108M	D9TZ5230BK	86675M	E3HZ5230A	86221M	EOHZ5230B	86153M	NMC86695M	86695M
B5T5230A	86137M	D3HA5225AAA	86113M	D9TZ5230BM	86675M	E3HZ5230A	86221M	FOHT5225AA	86535M	NMC86772M	86772M
B7C5230A	86136M	D3HA5225SAA	86300M	D9TZ5230BT	86675M	E3HZ5230C	86501M	FOHZ5230D	86535M	NMC86772M	86772M
B7Q5230A	86137M	D3HA5225FA	86102M	D9TZ5230BT	86675M	E3HZ5230C	86501M	FOHZ5230D	86535M	NMC86772M	86772M
B7TZ5230A	86136M	D3HS5230GA	86118M	D9TZ5230BT	86675M	E3HZ5230J	86503M	F0HZ5230F	86695M	NMC86772M	86772M
C0DD5230A	86136M	D3HZ5230A	86113M	D9TZ5230BK	86675M	E3HZ5230S	86183M	F0UZ5230F	86695M	NMC89107A	89107A
C1TT5230AR	86136M	D3HZ5230B	86502M	D9TZ5230BM	86675M	E3UZ5230F	86675M	F1HS5225FA	24050A	NMC89162A	89162A
C1TT5230AS	86136M	D3HZ5230C	86113M	D9TZ5230BM	86675M	E3UZ5230G	86675M	F1HS5225GA	24051A	NMC89163A	89163A
C1TT5230AT	86133M	D3HZ5230F	86300M	D9TZ5230BT	86675M	E3UZ5230H	86675M	F1HT5230AA	86695M	NMC89128C	89218C
C1TT5230BD	86200M	D3HZ5230M	86102M	D9TZ5230BT	86675M	E3UZ5230J	86675M	F1HT5230AA	86695M	NMC89296A	89296A
C1TZ5230A	86133M	D3HZ5230M	86102M	D9TZ5230BT	86675M	E4HT5230BA	86184M	F1HZ5230A	86695M	NMC89298C	89298C
C1TZ5230AS	86136M	D3HZ5255A	86113M	D9TZ5230BK	86675M	E4HZ5230A	86522M	F3HZ5A281A	89571K	NMC89309K	89309K
C2A5230A	86133M	D3TZ5230D	86675M	D9TZ5230BK	86675M	E4HZ5230B	86183M	F6HT5225A2A	86535M	NMC89450A	89450A
C2T25230A	86133M	D4TZ5230L	86164M	D9TZ5230BK	86675M	E4HZ5230B	86183M	F6HT5225L2A	86531M	NMC89450A	89450A
C3A5230S	86108M	D5HA5225HA	86200M	D9TZ5230BK	86675M	E4HZ5230B	86183M	F6HT5225NA1	86626M	NMC89519K	89519K
C3T25230A	86136M	D5HA5225HA	86200M	D9TZ5230BK	86675M	E4HZ5230B	86183M	F8HS5225AA	86531M	NMC89526K	89526K
C3T25230B	86137M	D5HZ5230G	86200M	D9TZ5230BK	86675M	E4HZ5230E	86183M	FW593360	86137M	NMC89526K	89526K
C3T25230B	86137M	D5HZ5230G	86200M	D9TZ5230BK	86675M	E4HZ5230E	86183M	G5TZ5230A	86118M	NMC89527K	89527K
C3T25230B	86137M	D5TA5225BDA	86669M	D9TZ5230BK	86675M	E4HZ5230E	86183M	G5TZ5230A	86118M	NMC89527K	89527K
C3T25230B	86137M	D5TA5225BDA1	86213M	D9TZ5230BK	86675M	E4HZ5230E	86183M	FREIGHTLINER®		NMC89528K	89528K
C3T25230B	86137M	D5TA5225DBA1	86512M	D9TZ5230BK	86675M	E5HZ5230A	86220M	859769	89450E	NMC89539K	89539K
C3T25230B	86137M	D5TA5225DBA1	86512M	D9TZ5230BK	86675M	E5HZ5230B	86200M	7013934	89450E	NMC89548K	89548K
C3T25230B	86137M	D5TZ5230AH	86213M	D9TZ5230BK	86675M	E5TZ5230AR	86675M	49550060	89019C	NMC89548K	89548K
C3T25230B	86137M	D5TZ5230AH	86213M	D9TZ5230BK	86675M	E6HS5C208AA	89440E	114596000	89503K	NMC89549K	89549K
C3T25230B	86137M	D5TZ5230AH	86213M	D9TZ5230BK	86675M	E6HS5C208AA	89440E	409586017	90983A	NMC89606K	89606K
C3T25230B	86137M	D5TZ5230CL	86164M	D9TZ5230BK	86675M	E6HS5C208AA	89440E	409833007	90984C	NMC89609K	89609K
C3T25230B	86137M	D5TZ5230CL	86164M	D9TZ5230BK	86675M	E6HS5C208BA	89440E	415653000	90987A	NMC89611K	89611K
C3T25230B	86137M	D5TZ5230J	86137M	D9TZ5230BK	86675M	E6HS5C208BA	89440E	6814910000	86196M	NMC89611K	89611K
C3T25230E	86136M	D5TZ5255AK	929026A	D9TZ5230BK	86675M	E6HS5C208BA	89440E	6814910100	86704M	NMC89759K	89759K
C3T25230F	86108M	D5VZ5230AF	86675M	D9TZ5230BK	86675M	E7HS5225AB	86655M	6814910100	86704M	NMC89784C	89784C
C3T25230G	86136M	D5VZ5230AZ	86675M	D9TZ5230BK	86675M	E7HS5225HA	86531M	6814910100	86704M	NMC89924C	89924C
C4TS5230A	86139M	D5VZ5230G	86675M	D9TZ5230BK	86675M	E7HT5225C2A	86529M	6814911000	22794A	NMC89964K	89964K
C4TZ5230A	86139M	D6HS5230AA	86200M	D9TZ5230BK	86675M	E7HZ5230A	86529M	A0410342	86102M	NMC89966K	89966K
C5TS5230A	86200M	D6HS5230DA	86145M	D9TZ5230BK	86675M	E7HZ5246G	923008A	A0410342000	86102M	NMC90378A	90378A
C5TZ5230A	86136M	D7HT5225AJA	86200M	D9TZ5230BK	86675M	E7HZ5246G	923008A	A0410562	86108M	NMC90378A	90378A
C5TZ5230C	86136M	D7HT5225BAT	86213M	D9TZ5230BK	86675M	E7HZ5246N	924004A	A0410617	86108M	NMC90547K	90547K
C5TZ5230D	86136M	D7HT5225BEA	86195M	D9TZ5230BK	86675M	E7HZ5255A	926011A	A0410618	86108M	NMC90547K	90547K
C6TZ5230A	86125M	D7HT5225BNA	86203M	D9TZ5230BK	86675M	E7HZ5A231C	89501K	A0410879	86108M	NMC90842C	90842C
C6TZ5230AH	86108M	D7HT5225BTA	86213M	D9TZ5230BK	86675M	E7TZ5230H	86675M	A0410879	86102M	NMC90895U	90895U
C6TZ5230D	86136M	D7HT5225BTA	86213M	D9TZ5230BK	86675M	E8HS5225MA	22380A	A0411447	86200M	NMC90902K	90902K
				D9TZ5230BK	86675M	E8HT5225A2A	86529M	A0411694	86130M	NMC	

Cross Reference by Manufacturer

OEM No.	Our No.	OEM No.	Our No.	OEM No.	Our No.	OEM No.	Our No.	OEM No.	Our No.	OEM No.	Our No.
NMC90910A	90910A	5324895000	89551K	2374637	86115M	15552174	86724M	7642000628	86556M	59428201	86148M
PPD0415653000	90987A	5325434200	86149M	2382391	86139M	15555594	86557M	7697001024	89059A	59430025	89167A
	FWD™	5330349000	86133M	2383254	86115M	15571897	21063A	7697001584	89218A	59590224	89166A
53172	86125M	5335644000	86570M	2392391	86139M	15572769	86727M	7697001585	89058A	59607549	89056A
54962	86108M	5525755000	86542M	2393290	86137M	15572770	86727M	7734000100	89256A	59693432	89544K
114053	86135M	139768N000	86624M	2393291	86139M	15572771	86723M	7734000101	89274A	59693564	89422A
180672	86125M	5333396000N	86125M	2407607	86106M	15572772	86723M	7814001026	89774C	59710301	89030A
197721	86139M		GMC™	2423714	86139M	15609879	86724M	7910015066	89240A	59758623	86168M
420920	49140A	651995	86133M	2424277	86139M	15628117	86756M	7910015358	89794K	59764142	89547K
437930	90368A	651996	86133M	2427177	86137M	15638767	86722M	7910016250	89047A	59764159	89186A
496696	49150A	651997	86133M	2427277	86139M	15647159	89520K		HENDRICKSON®	59764225	89165A
531742	86125M	658900	86108M	2428242	86137M	15658354	86725M	AA33992	86108M	59764233	89092A
533938	86108M	660098	86125M	2434175	86137M	15670818	86722M	AT650110	86144M	59845784	89119A
642050	49125A	660901	86131M	2444889	86137M	15982892	86724M	AT650111	49160A	598106550	89006A
10175432	86173M	661997	86133M	2450498	86115M	94037873	89143A	DA3590811	86125M	891706	86172M
10175510	86108M	661998	86133M	2453809	86136M	94044319	86690M	DA3590820	86300M		INGRAM™
10175578	86131M	663283	86102M	2453865	86139M	94047627	86690M	DA3590823	86108M	61066	90878A
10175581	86102M	663284	86102M	2456787	86133M	155003803	86200M	DA3590825	86108M		INSLEY™
10175623	86150M	666800	86118M	2482970	86108M	155609879	86724M	DA3590827	86139M	520197	86137M
16006166	86135M	679399	86118M	2482972	86200M	5127819X0121	89797K	DA3590829	86213M	520208	86173M
16006168	86139M	682154	86152M	2483764	86200M	ML11283	89520K	DA359087	86115M	520328	86132M
16006172	86125M	685217	86108M	2485787	86139M	ML112841	90875A	DA359088	86132M	520331	86106M
P0187300	86200M	687135	86118M	2488074	86137M	ML112842	90877A	DX3590812	86133M	520371	86125M
	GALION™	693298	86137M	2488076	86139M	ML11285	89173A	DX3590813	86102M	520372	86147M
D100312	86175M	693299	86164M	2488077	86148M	ML11286	89187C	DX3590816	86108M	520373	49140A
D101877	86168M	695224	86200M	2705085	929027A	ML12333	90877A	DX3590826	86108M	520379	86139M
D114338	86139M	695423	86108M	2705119	929027A	S11517	49150A	DX3590834	86200M		INTERNATIONAL TRUCKS®
D117248	86106M	700002	86168M	3693710	86136M	S11914	49140A	DX3590837	86195M	5132650	89510K
D126170	86137M	717202	86203M	3724300	86136M		GOERLICH®	DX3590842	86130M	119144H	86139M
D645239	86173M	717217	86200M	3741399	86136M	B500V	900273A	DX3590844	86200M	137820R91	86118M
H37006	86173M	718051	86200M	3816360	86136M		GORMAN-RUPP®	DX3590856	86195M	142414R91	86137M
RH49688	86172M	722872	90376A	3816361	86136M	29334119	86136M	DX359089	86108M	1518317C1	86547M
	GARDNER-DENVER™	724859	86164M	3850422	86136M	29334134	86173M		HERCULES™	1608381C1	926072A
166395	86139M	793920	90378A	3850423	86136M		GRADALL®	400005007	86191M	1608681C1	926005A
1155562	49120B	796790	86164M	3850424	86137M	90200519	11026T	400005018	86192M	1609419C1	86102M
1414794	86220M	798803	86213M	3873128	86137M	90205815	49125A		HOBART™	1610293C3	927010A
2014355	86191M	2002206	86195M	3890258	86136M		GRIMMER SCHMIDT™	282894	89114A	1610299C3	929001A
2016573	86147M	2002655	86153M	3890340	86136M	1017030	86190M	283667	89093A	1616478C1	86606M
5840209	86193M	2004200	90355A	3904077	86137M	12462838	49125A		HONDA™	1616657C1	86753M
6662242	49025N	2006718	86195M	3907220	86139M	101159229A	86136M	18355ZN1003	49025N	1618487C2	929038A
50174500020	89440E	2008782	86137M	3928084	86137M		GROVE®	18355ZN10030	49025N	1618490C2	929038A
200SPQ063	86125M	2011503	90363A	3930268	86136M	3250018	49120B		HOUGH™	1622155C2	86755M
202SPT063	86180M	2013323	86526M	3931391	86137M	7258000701	89422A	108435H45	86521M	1647375C1	86533M
	GEHL®	2020249	86195M	3931392	86137M	7300001050	89763K		HYSTER™	1647960C1	86538M
135370	89090A	2022825	86130M	3941446	86136M	7300001055	89767K	159349	86125M	1647960C2	86185M
	GENERAC®	2023482	90354A	3941447	86137M	7300001068	89766K	217149	86131M	1647960C2	86538M
59902	89430E	2023483	90358A	3941448	86137M	7364002420	89252A	280905	49120B	1647961C2	86536M
59940	89435E	2030130	90368A	3941457	86137M	7406000158	89101A	2288355	86108M	1647998C1	86631M
65805	89450E	2030131	90364A	3954016	86136M	7406000178	89073A	SK357642	86130M	1647998C1	86631M
	GILL™	2030132	90365A	3954017	86137M	7406000423	89154A	SS191521	49140A	1647998C2	86536M
3C	49115U	2030134	90363A	3954018	86164M	7406001091	89082A		INGERSOLL-RAND™	1647999C1	86545M
3CIP	49115U	2030812	86200M	3954020	86164M	7406100007	89924A	1034713	89420A	1647999C2	86545M
5C20B	49120B	2033269	86130M	3954021	86137M	7450000109	89967K	1034730	89110A	1648000C1	86537M
5CV20	49120B	2046594	86505M	3963833	86137M	7642000004	86173M	8332126	89440E	1648000C2	86537M
5CV24	49125A	2046609	86505M	3981941	86137M	7642000005	86173M	10444214	86192M	1648038C1	86607M
6C24	49125A	2046609	86664M	3981948	86136M	7642000009	86168M	12974168	89250A	1648039C1	86751M
6C30	49130A	2057214	86153M	3996417	86137M	7642000020	86108M	13065271	89218A	1648056C1	86757M
6C34	49135A	2058727	86506M	5020398	89514K	7642000022	86131M	35107192	86137M	1652937C1	89889A
6CV24	49125A	2061470	86130M	5108720	86175M	7642000027	86108M	35109107	86125M	1653532C1	925005A
6CV30	49130A	2069207	86153M	5119172	86172M	7642000028	86102M	35113539	86139M	1657101C1	89882A
6CV34	49135A	2069773	89508K	5119173	86173M	7642000029	86192M	35576721	86192M	1657101C2	89882A
8CV34	49135A	2079900	86504M	5179058	86175M	7642000031	86159M	35797877	86206M	1657433C1	86545M
8CV40	49140A	2079904	86506M	5179206	86173M	7642000032	86190M	35846484	89430E	1657433C2	86545M
8CV50	49150A	2119295	929027A	5181515	86172M	7642000053	89194U	35857036	89450E	1657434C1	86537M
8CV60	49160A	2119352	929027A	9013928	86147M	7642000054	86130M	56897978	86147M	1657436C1	86547M
	GILLIG CORP.™	2199800	86137M	10638782	89520K	7642000068	49150A	59179226	89543K	1657436C2	86547M
5323221	90358A	2295978	89509K	10640231	89507K	7642000614	49140A	59354100	89187A	1658111C1	86751M
5315440000	89519K	2306634	86137M	15507925	89624K	7642000616	49120B	59362582	89055A	1662057C1	89521K
5316224000	86153M	2306635	86136M	15521179	86130M	7642000620	86119M	59392266	89193U	1662058C1	89522K
5324892000	86147M	2353719	90913A	15549646	86557M	7642000623	86526M	59394288	86191M	1662059C1	89523K

Cross Reference by Manufacturer

OEM No.	Our No.	OEM No.	Our No.	OEM No.	Our No.	OEM No.	Our No.	OEM No.	Our No.	OEM No.	Our No.
1662060C1	89524K	338614C1	89512K	475674C1	89193U	572479C1	86184M	XH424G	89607K	KENWORTH™	
1662061C1	89525K	343458C91	86135M	477662C1	90958A	577265C1	929011A	XH436G	89608K	1808048	89075A
1662062C1	89526K	343459C91	86667M	479929C3	86598M	578068C1	86185M	XH459EM	86740M	K0773421	90358A
1662063C1	89527K	3511319C1	86776M	481445C2	86511M	578068C1	86185M	XH4RCC	89440E	K130166	90956A
1662064C1	90464K	3511320C1	86531M	481727C2	86510M	578070C1	86513M	XH518G	89609K	K16844	86108M
1662065C1	89529K	3521583C1	925070A	482167C1	86512M	580194C1	86135M	XH518SS	89731K	K16854	86531M
1664453C2	86754M	3521589C1	925071A	482167C1	86512M	58162HA	86136M	XH536SS	89733K	K16858	86196M
1666966C2	924008A	356153C1	86145M	482168C1	926005A	582122C1	86514M	XH5510EM	86682M	K16948012	90983A
1668838C1	925005A	358921C1	86153M	482174C1	926062A	582167C1	90823A	XH559EM	86739M	K18010742R	89901A
1668841C2	929016A	360488C1	929027A	482612C2	929016A	583967C91	90374A	XH89440	89440E	K180109612CP	89046C
1668843C1	929016A	360803C1	86113M	482614C2	929016A	583968C91	90375A	XH89440A	89440E	K180109660CP	89296C
1668845C1	929016A	366303C1	86113M	482616C1	929011A	583969C91	90376A	XH89450A	89450E	K18014764L	90980C
1668846C1	929016A	385203C1	86667M	482618C1	929011A	583970C91	90378A	ZFS90914K	90914K	K18014764L	90980C
1669749C1	86548M	390226C91	89503K	482620C1	929011A	583971C91	90379A			K18014764R	90979C
1669751C1	86548M	394924C2	86137M	482622C1	929011A	583973C91	90352A			K18014764R	90979C
1669751C2	86548M	404508R1	49130A	482624C1	929011A	583974C91	90353A			K18014766	90981A
1672105C91	89503K	409828C1	86108M	482626C1	929011A	583975C91	90354A			K18015593	89117A
1673907C1	90083A	418705C1	86144M	483005C1	86667M	583977C91	90355A	ISUZU™	9404319	86690M	K180B10742R
1673907C3	90083A	424858C1	86108M	483005C2	86135M	583979C91	90358A	94037873	86913A	MFM100165	86130M
1678071C1	929011A	425137C1	86132M	484253C1	86185M	583979C91	90358A	94044319	86690M	MFM100172	86130M
1678074C1	929011A	425507C1	86108M	484476C2	86570M	583980C91	90546K	94047627	86690M	MFM100295	86130M
1680524C1	86751M	425624R91	89505K	484885C1	86669M	583981C91	90547K			MFM100410	86130M
1680525C1	86757M	425937C1	86132M	485934C1	86130M	584173C1	86514M			MPM090161	86102M
1688108C1	929038A	426428C91	86512M	486089C1	86195M	586606C1	86130M	J & J PARTS™	1240703004	19141N	
1688109C1	929038A	429619C1	86113M	486109C91	86130M	587519C2	90966A	JACKSON VIBRATORS™	4791	86172M	MPM090167
1688111C1	929038A	431256C1	86108M	486110C1	86130M	587521C2	90967A	4806	86173M	MPM100106	86130M
1688662C2	86531M	431517R91	86108M	488064C2	86102M	5904062C1	86514M	1510991	86139M	MPM100127	86195M
172691R1	929003A	433192R91	89507K	488710C1	86184M	591593C91	925014A			MPM100338	86195M
172699R1	929003A	434252R91	89506K	488710C2	86184M	591595C91	926008A	JAEGER™	35673022	86172M	MSM090142
188575R91	86133M	434507C91	86108M	489890C2	86570M	591595C92	926008A	35673580	86173M	MUM090022	86108M
2004456C1	90877A	434836C1	86108M	495351C2	86130M	593782C91	926008A			PM090141	86108M
2004557C1	925066A	434847C1	86102M	499388C1	89880A	593782C92	926008A				
200827R91	86133M	436198C1	86113M	499421C1	86533M	593783C1	924023A	JLG®	1120405	89435E	716540
2008955C1	86774M	437790C1	86669M	499495C1	86200M	593783C11	926008A	1120423	89440E	757883	86148M
2013204C1	925068A	439248R91	86133M	499528C1	86139M	598474C1	86102M				
2018471C1	86536M	439797C1	86151M	499528C1	86139M	606T123A	86135M	JOHN DEERE™	42023149	12417T	LC12PU1003P1
202000R91	86133M	440377C1	86151M	4999421C1	86533M	689400R91	86131M	42026436	12417T	AE20601	LC12PU1005P1
2021550C2	86777M	440378C1	86151M	500872C1	86195M	690420R91	86125M	AE20601	86139M	AH11054H	90875A
2033675C1	86631M	442927C1	86108M	501462C1	86102M	694848R91	86131M		86178M	AM115838	L312PU1003P1
2037707C1	86775M	442928C1	86102M	501463C1	86533M	72095R91	86137M		49025N	AN203989	89520K
2040926C1	86754M	442930C1	86108M	501464C1	86130M	753980C91	86102M		89505K	AN203989	89525K
2041964C1	86757M	447124C1	86113M	503377C1	86108M	762683C91	86118M		89559B	AN273958	23991
2041965C1	86776M	447125C1	86113M	504886C1	86130M	762782C91	86147M		90870A	AR86603	125640
211618R91	86139M	4507036R1	49160A	504926C1	86185M	762783C91	86118M		89440E	AT10646	125656
211918R91	86139M	453180C1	86145M	504926C1	86185M	763196C91	86132M		86177M	AT10646	125657
214463R91	86133M	454306R91	86108M	508797C91	89527W	780067C91	89510K		89525K	AT128887	125658
234658R91	86164M	454308C91	86102M	508798C91	86102M	783788C1	86300M		89548K	AT175376	125663
240683R91	86667M	462513C91	86108M	508804C1	86511M	789843C1	86300M		89558B	AT180264	4204307
242148R91	86137M	463026C1	86108M	511343C1	929007A	795570C1	86147M		49020N	AW26849	4204310
244007R91	86139M	463765C1	86159M	511343C1	929007A	865034C91	86133M		90587K	F120959	4204351
244007R91	86139M	464643C1	86139M	519517C3	929007A	868431R91	86115M		90885A	F122164	4204360
246017R91	86115M	464643C1	86139M	520541C1	86153M	870876C91	86133M		16487T	PM16487T	4204363
256017C91	86151M	465971C1	86139M	523719C3	86544M	870876R91	86133M		89096A	R500204	4204376
258387C1	90822A	465971C1	86139M	523962C1	89196U	871834R91	86108M		18901T	RE20224	4204378
258387C2	90822A	465971C91	86139M	524605C1	86300M	893944R92	89501K		89505K	RE48944	4204404
260445C91	86125M	465984C1	86139M	531815R1	49125A	893945R92	89520K		89560B	RE500329	4204404
2647998C1	86631M	465984C1	86139M	532347C91	86108M	97428R91	86113M		89881A	T158264	7095789
265748C91	86125M	466817C1	86159M	532383C1	90962A	976488R91	86125M		90914K	TCA51078	9949979
277177C91	86118M	466894C1	86139M	532395C1	89893A	979491R91	86131M				50001551
278390C91	86113M	466984C91	86139M	548287C1	86195M	979541R91	86108M				50001561
285203C1	86135M	466984C91	86139M	548804C1	86511M	985125R91	86131M				86137M
293994C91	86667M	467614C1	86159M	549464C1	86136M	985721R91	86131M				86173M
3000072C1	86536M	468720C1	86597M	549465C1	86137M	987177R91	86127M				86173M
302752C91	86144M	469801C1	86102M	549466C1	86164M	989288R91	86132M				86177M
312137C91	86118M	471382C1	86139M	549469C1	86139M	989443R91	86125M				86139M
315120C91	86115M	471382C2	86139M	549483C1	86200M	995124R91	86131M				86139M
323545R91	86115M	471382C91	86139M	549485C1	86305M	998025C1	86127M				86137M
324937C1	86153M	471382C91	86139M	549559C91	89528K	V3714	86188M				86106M
324937C91	86153M	475306C2	89892A	549563C91	89521K	XH412G	90903K				86192M
333476C91	86145M	475354C1	86195M	556687C1	86102M	XH418G	89606K				86148M
											86175M

Cross Reference by Manufacturer

OEM No.	Our No.	OEM No.	Our No.	OEM No.	Our No.	OEM No.	Our No.	OEM No.	Our No.	OEM No.	Our No.
420V4361	86168M	11ME2293	90358A	2ME339	86108M	583989074C	89074C	583989611K	89611K	5893990847C	90847A
420V4382	86159M	11ME229P4	90354A	2ME347	86127M	583989075A	89075A	583989624K	89624K	MAN™	
420V4387	86106M	11ME229P6	90368A	2ME349	86132M	583989075C	89075C	583989625K	89625K	8197445601Z	89528K
420V4388	86102M	11ME241	89503K	2ME355	86127M	583989090A	89090A	583989644K	89644K	MANITOWOC™	
420V4390	86213M	11ME29	89532K	2ME355A	86127M	583989094A	89094A	583989645K	89645K	536907	86173M
KOHLER®		11ME299P6	90547K	2ME356	86135M	583989095A	89095A	583989674K	89674K	536912	86175M
225317	49115U	16MEA31	86514M	2ME357	86131M	583989096A	89096A	583989675K	89675K	536917	86125M
253237	86173M	16MEA31P2	86514M	2ME361P4	27961A	583989097A	89097A	583989686K	89686K	536961	86106M
274649	89527K	16MEA32P4	86196M	2ME361P5	86149M	583989102A	89102A	583989687K	89687K	MAREMONT®	
275679	48111U	1ME19301	86108M	2ME363P5	23328A	583989103A	89103A	583989688K	89688K	101861	86139M
277679	49115U	1ME19301P029	86102M	2ME366	86132M	583989105A	89105A	583989713K	89713K	101995	86137M
278621	49025N	1ME19301P1	86108M	2ME367	86300M	583989105C	89105C	583989714K	89714K	102608	86136M
EX250300	49025N	1ME19301P10	86102M	2ME371	86108M	583989106A	89106A	583989715K	89715K	102732	86500M
KOMATSU™		1ME19301P2	86102M	2ME371P3	86149M	583989107A	89107A	583989723K	89723K	102793	86135M
2070168230	89527K	1ME19301P5	86108M	2ME372	86213M	583989107C	89107C	583989724K	89724K	102863	86102M
1280227H1	89050C	1ME19301P6	86131M	2ME373	86108M	583989108A	89108A	583989727K	89727K	102865	86144M
1431325H1	89541K	1ME19301P7	86108M	2ME374	86102M	583989115A	89115A	583989728K	89728K	102866	86188M
1431326H1	89542K	1ME19301P9	86108M	2ME374P1	86102M	583989115C	89115C	583989729K	89729K	102867	86189M
3EC03A5160	90869A	1ME1930P7	86108M	2ME374P2	86102M	583989116A	89116A	583989730K	89730K	102872	14245T
42502A2130	90358B	1MEA19301P5	86108M	2ME375	86108M	583989117A	89117A	583989731K	89731K	102875	16487T
42502A2130	90358B	2ME139	86113M	2ME376	86108M	583989117C	89117C	583989733K	89733K	102882	49120B
4608517H1	89020A	2ME153	49140A	2ME378	86133M	583989123A	89123A	583989744C	89744C	102883	49125A
4608518H1	89430E	2ME211	86127M	2ME384	49150A	583989126A	89126A	583989749C	89749C	102884	49130A
4608518H1	89430E	2ME211P3	86127M	2ME391	86116M	583989145A	89145A	583989759K	89759K	102885	49135A
PB2601	90376D	2ME235	86180M	2ME399	86108M	583989145C	89145C	583989763K	89763K	102886	10156T
KUBOTA®		2ME236	86147M	2ME49301	86131M	583989146A	89146A	583989766K	89766K	102889	49140A
3A01112130	90914K	2ME236P1	86195M	2ME49301P11	86130M	583989146C	89146C	583989767K	89767K	102890	49150A
LEACH™		2ME247	49150A	2ME49301P2	86130M	583989155A	89155A	583989771K	89771K	102891	86125M
107415	89146A	2ME248	86195M	2ME49301P3	86195M	583989161A	89161A	583989772K	89772K	102892	86148M
107416	89156A	2ME251	86127M	2ME49301P5	86195M	583989162A	89162A	583989780A	89780A	102893	86213M
LEROI®		2ME29301P1	86130M	2ME49301P7	86430M	583989166A	89166A	583989781C	89781C	102894	86153M
7811	86175M	2ME29301P12	86200M	2MEX328	86125M	583989167A	89167A	583989782A	89782A	102895	86185M
L78140	86173M	2ME29301P13	86130M	48RU2341	89533K	583989173A	89173A	583989783A	89783A	102896	86510M
L78147	86172M	2ME29301P14	86130M	4ME21698	89897A	583989187A	89187C	583989784A	89784A	102898	86511M
L78152	86177M	2ME29301P17	86195M	4ME32603	90922A	583989196U	89196U	583989784C	89784C	102899	86505M
L78157	86150M	2ME29301P19	86195M	4ME32612	89887A	583989198U	89198U	583989897A	89897A	102901	86529M
LINCOLN™		2ME29301P20	86195M	583927961A	27961A	583989256A	89256A	583989899A	89899A	102902	86131M
L8461	49120B	2ME29301P21	86145M	583949150A	49150A	583989276A	89276A	583989923A	89923C	102974	86536M
S20461	49115U	2ME29301P22	86130M	583986102M	86102M	583989277A	89277A	583989923A	89923C	103021	86537M
S24645	49025N	2ME29301P5	86200M	583986108M	86108M	583989435A	89435E	583989924A	89924A	103022	86115M
LINK-BELT®		2ME29301P6	86102M	583986113M	86113M	583989435A	89435E	583989940A	89940C	106250	86184M
C6H0239	89923C	2ME29303P7	86102M	583986127M	86127M	583989440A	89440E	583989950A	89950C	106275	86183M
LOCKWOOD™		2ME3101	86127M	583986130M	86130M	583989440A	89440E	583989950A	89950C	108030	86164M
8733	86178M	2ME3102	86514M	583986131M	86131M	583989440C	89440E	583989965K	89965K	108052	86695M
8734	86172M	2ME3102	86541M	583986132M	86132M	583989440C	89440E	583989966K	89966K	108057	86690M
LODAL™		2ME3104	86533M	583986145M	86145M	583989450A	89450E	583989967K	89967K	108058	86697M
9963125	86772M	2ME3104P2	86430M	583986153M	86153M	583989450A	89450E	583989985C	89985C	108221	10811T
LONG™		2ME3104P3	86196M	583986514M	86514M	583989450C	89450E	583989986C	89986C	108222	11026T
753833	89420A	2ME3105	86541M	583986533M	86533M	583989450C	89450E	583989987C	89987C	108223	11650T
761841	89541K	2ME3106	86542M	583986536M	86536M	583989503K	89503K	583989988C	89988C	108224	11651T
791365	89422A	2ME3106A	86542M	583986545M	86545M	583989513K	89513K	583989989C	89989C	108225	11669T
791366	89542K	2ME3112	86543M	583986682M	86682M	583989514K	89514K	583989993C	89993C	108227	11731T
806556	86177M	2ME3118	86771M	583986700M	86700M	583989527K	89527K	583990358A	90358B	108229	13900T
LORAIN®		2ME3118A	86771M	583986712M	86712M	583989528K	89528K	583990358A	90358B	108231	14222T
B126367	86102M	2ME3119	86526M	583986713M	86713M	583989533K	89533K	583990368A	90368B	108232	14472T
B126705	86106M	2ME3135	86531M	583986739M	86739M	583989543K	89543K	583990368A	90368B	108233	14490T
C138018	86206M	2ME314	86139M	583986740M	86740M	583989545K	89545K	583990386A	90386B	108234	14663T
D49456	86173M	2ME314BP3	86139M	583986771M	86771M	583989547K	89547K	583990386A	90386B	108236	15088T
D71668	86139M	2ME335	86127M	583989014A	89014A	583989548K	89548K	583990448C	90448C	108237	15572T
E56990	86125M	2ME335AP2	86153M	583989019A	89019A	583989549C	89549C	583990449C	90449C	108239	17120T
MACK®		2ME335AP3	86127M	583989019C	89019C	583989549K	89549K	583990451A	90451A	108240	17275T
2070201	89559B	2ME335P1	86125M	583989025A	89025A	583989558K	89558K	583990451C	90451C	108241	17704T
2070201	89559K	2ME336	86127M	583989045C	89045C	583989559K	89559K	583990452A	90452A	108242	18202T
2141850	89313K	2ME336B	86127M	583989046A	89046A	583989559K	89559K	583990452C	90452C	108243	18901T
2500931	89503K	2ME337A	86106M	583989046C	89046C	583989569K	89569K	583990598C	90598C	108247	22150T
2681850	90368B	2ME337AP3	86153M	583989047A	89047A	583989571K	89571K	583990847C	90847C	108249	22152T
2681850	90368B	2ME337P1	86106M	583989049A	89049A	583989606K	89606K	583990854A	90854A	108252	22507T
583986113	86113M	2ME337P2	86106M	583989056C	89056C	583989607K	89607K	583990859C	90859C	108255	48111U
5000444758	86608M	2ME337P3	86153M	583989057C	89057C	583989608K	89608K	583990902K	90902K	108257	86177M
11ME229	90355A	2ME338	86127M	583989074A	89074A	583989609K	89609K	583990903K	90903K	108258	86178M

Cross Reference by Manufacturer

OEM No.	Our No.	OEM No.	Our No.	OEM No.	Our No.	OEM No.	Our No.	OEM No.	Our No.	OEM No.	Our No.
310150	89091A	MERCEDES™		199254	86177M	107789B	86130M	40CS248A	89045A	60X50CS1120C	90579C
310152	89093A	LM6854920840	90366B	578013	89547K	109820B	86130M	40EL45103A	89780A	60X50CS148C	924072C
310154	89095A	LM6854920840	90366B	632578	89430E	110792A	89146C	40EL45104A	89074A	60X50CS160C	90905C
310156	89097A	MILLER™		637982	89025A	111641B	49150A	40EL45203A	89782A	60X50CS172C	90447C
320290	89124A	88528	49115U	638256	89440E	17390F	86139M	40EL45204A	89084A	60X50CS184C	90448C
320293	89117A	118073	89430E	638451	89440A	26685A	86133M	40EL70270A	89238A	60X50CS196C	90449C
340362	89021A	181134	89073A	638451	89440E	29424A	86300M	40EL90116A	89105A	60X50CS248C	90568C
340363	89051A	280842	89091A	638960	89548K	47786B	86108M	40EL90117A	89106A	60X50CS260C	90570C
340364	89024A	283666	89165A	86534869	89559B	47786BX	86108M	40EL90217A	89115A	60X50CS272C	90571C
340366	89027A	283865	89095A	86534869	89559K	53258B	86102M	40EL90219A	89116A	60X50MS1108C	90577C
340367	89057A	285253	89185A	86546727	89050C	54906B	86131M	40EL90242A	89094A	60X50MS120C	90578C
340368	89030A	285254	89105A	D6NNS252C	900040K	55183G	86300M	40EL90243A	89095A	60X50MS148C	900035C
510320	89505K	285276	89166A	D8NNS252AA	900041K	6005G	86125M	40FA475	90575A	60X50MS196C	90576C
548140	89274A	285284	86144M	V18827	900044K	69427B	86195M	40FC	89568K	60X50MS260C	900094C
548141	89276A	286687	89102A	NORTH AMERICAN BUS™			69491B	40FBZ	89555K	65X120CF	90579C
548142	89277A	286992	89026A	5015767	90904A	69941BX	86130M	40FC	89965K	8175C42G01	89559B
548143	89163A	287602	89923A	436031401900	89450E	76685A	86133M	40GZ	89548K	86132M	86132M
548175	89185A	287602	89923C	NORTHWEST ENGINEERING™			80000FT6	40HD	90867A	86305M	86305M
548176	89172A	408546	86193M	62104527	49160A	EE100601	86147M	40STA120	89661K	86502M	86502M
548180	89186A	408547	89184A	NOVABUS™			P104100	40TA	89940A	86505M	86505M
548181	89173A	408594	89103A	G1017916	90378B	RH04066	89216A	40TS118A	89145A	86624M	86624M
548182	89187A	408664	89105A	N16165	90368B	RH102648	89046A	40TS118C	89145C	86664M	86664M
548184	89278A	408770	89102A	OLIVER™			RH103339	40TS218A	89155A	89107A	89107A
TD1	86137M	4064641	49115U	103417A	14245T	RH104063	89074A	40TS218C	89155C	89548C	89548C
TD17	86102M	4064642	49120B	7AA452A	14245T	RH106822	89045A	40TX218C	89155C	89549C	89549C
TD2	86139M	4064644	49125A	ONAN™			OTTAWA™		89513K	89549K	89549K
TD20	86144M	84B10351	89090A	1552046	89430E	90002071	89440E	40VBAND	89185A	89619K	89619K
TD22	86136M	84B10352	89092A	1552908	49120B	PACCAR™		40X30R403A	89186A	90442C	90442C
ZF305	49120B	84B10441	89087A	1553181	89450E	86700	86700M	5018SBELL	89789K	90MG10S4	90461C
ZF306	49125A	MINNPAR™		1553372	90092A	89058	89058A	505620S3	89744C	90MG20S4	89749C
ZF307	49130A	236922	89420A	4101256	89450E	10MG10S4	90461C	50CS1108C	90526C	90MG30S4	89774C
ZF308	49135A	6812826	86177M	4101256	89450E	10MG20S4	89749C	50CS1120C	90614C	90MG31S3	89745C
ZF604	49140A	73061656	86119M	155242904	49025N	10MG30S4	89774C	50CS2108C	928011C	90MG40S4	89995C
ZF605	49150A	MITSUBISHI™		155252701	49125A	10MG31S3	89745C	50CS218A	89156A	90MG41S3	89996C
ZF606	86145M	MC632928	86690M	155252702	49130A	10MG40S4	89995C	50CS296C	89298C	90UH1	89539K
ZF615	86183M	MORBARK®		155311101	89425A	10MG41S3	89996C	50DTS51A	90452A	M10102	86102M
ZF626	86184M	29234562	86191M	155311102	89430E	10UH2	89540K	50DTS51C	90452C	M10108	86108M
ZF855	86125M	29323025	49115U	155311103	89430E	25TS212A	89151A	50EL15260A	89133A	M10127	86127M
ZF859	86148M	29323082	86148M	Z600030129	89450E	30EL45101A	89073A	50EL45106A	89075A	M10130	86130M
ZF860	86213M	MOTOR COACH™		Z600030129	89450E	30EL45200A	89083A	50EL45106C	89075C	M1014	86144M
ZF868	86153M	194182	89528W	ORENSTEIN-COPPEL™		30EL90111A	89101A	50EL70270A	89239A	M10144	86144M
ZF869	86185M	194186	89527K	203403600	89101A	30EL90112A	89102A	50EL90121A	89108A	M10145	86145M
ZF917	86505M	19040276	90531K	ORIONBUS™		30EL90212A	89234A	50EL90123A	89784A	M10196	86196M
ZF947	86536M	19040290	90887A	10771010	89502K	30EL90239A	89090A	50FA55	90569A	M10305	86305M
ZH003	86203M	8L20101	89503K	20726071	90873A	30EL90240A	89091A	50FBC	89569K	M10514	86514M
ZH008	86164M	8L2072	89520K	20778041	89513K	30FBC	89566K	50FBZ	89559B	M10531	86531M
ZH009	86135M	G5003195	89528K	50742078	89558K	30GZ	89545K	50FBZ	89559B	M10547	86547M
ZH012	86557M	G5010400	89923C	50774247	90531K	30HD	90866A	50FC	89966K	M10682	86682M
ZH201	86200M	G5010400	89923C	50774273	90887A	30STA	89006A	50FCTURBO	89967K	M10713	86713M
ZH202	86131M	MWM™		50774275	90877A	30STA1	89006A	50GZ	89549K	M10739	86739M
ZH203	86108M	42262	89430E	50774277	89519K	30STA120	89660K	50HD	90868A	M10740	86740M
ZH206	86102M	422612	89435E	60774504	90887A	30TS212A	89153A	50MS1108C	90597C	M20125	86125M
ZH209	86113M	422615	89440E	BS2159112	89622K	35E690241A	89093A	50MS296C	90591C	M20137	86137M
MASSEY-FERGUSON™		NACCO™		BS2159114	89623K	35EL45102A	89077A	50SG20S3	89744C	M20139	86139M
1495014M1	86173M	T1477429	89430E	OSHKOSH™		35EL45202A	89087A	50STA120	89662K	M20147	86147M
470263M91	49130A	NEOPART™		1436400	89186A	35EL90114A	89103A	50TCCID	90534A	M20153	86153M
525193M1	86135M	T1477429	89430E	1488910	86130M	35EL90115A	89104A	50TCCOD	90533A	M20164	86164M
578090M92	14222T	NEOPLAN USA™		1569180	49110U	35EL90214A	89235A	50TS118A	89146A	M20183	86183M
MCI™		NM0201007005	89796K	1712190	86148M	35EL90215A	89114A	50TS218C	89146C	M20185	86185M
19040357	90872A	NM0201007006	90366B	1838180	89626K	35EL90241A	89093A	50VBAND	89503K	M20213	86213M
394202023	90366B	NM0201007006	90366B	1904790	89218C	35GZ	89547K	50X40R405A	89187A	M20512	86512M
8G191	90365B	NEW FLYER™		1946300	90359A	35TS212A	89154A	525VBAND	90531K	M20529	86529M
AZ44000223	90358B	39132	89503K	1946300	90359B	35VBAND	89512K	6018SBELL	89790K	M20536	86536M
G1019097	90358B	41632	89550K	2102130	86194M	35X30R303A	89274A	60FBC	89570K	M30510	86510M
MELROE™		41634	89460C	2261270	86610M	4018SBELL	89788K	60FBZ	89560B	M30511	86511M
6515915	49120B	41634	89923A	3278969	90531K	4050UMB	89518K	60GZ	89550K	M30537	86537M
6519594	12417T	66899	89549K	10038G	86180M	40CN304A	89162A	60SG20S3	90856C	MGK103	89763K
6670562	Q186201	NEW HOLLAND™		10154F	86139M	40CS224A	89043A	60STA	89698K	MGK104	89767K
		167650	86178M	10297GX	89560B	40CS224C	89043C	60STA120	89698K	MGK94	89966K
		197700	86177M	105G	86131M	40CS236A	89044A	60X50CS1108C	90450C	PGK53	89771K

Cross Reference by Manufacturer

OEM No.	Our No.	OEM No.	Our No.	OEM No.	Our No.	OEM No.	Our No.	OEM No.	Our No.	OEM No.	Our No.
PGK63	90857K	LL84788	86137M	10020	86130M	HD3078	86119M	XB497	929007A	76055103	49150A
PPD0409586017	90983A	LL84796	86150M	10027	86535M	HD3079	86139M	XB4AXF2	924037A	76056606	86125M
PPD0415653000	90987A	R026594002	49120B	10028	86533M	HD325	86137M	XB4M1	86630M	76059914	89187A
PPD0415686000	90987A		PIERCE®	10029	86531M	HD350	86188M	XC234M1	86164M	76061884	89231A
PPD1652937C1	89889A	420019	89118A	10045	86547M	HD359	86150M	XC4AXR6	925002A	76062077	89156C
PPD1657101C	89882A	420020	89101A	10060	86656M	HD363	86150M	XC4MD6	86557M	76064799	89283A
PPD1673907C1	90083A	420039	86102M	10061	86526M	HD400	86189M	XC4TF11	924027A	76064800	86180M
PPD475306C2	89892A	420076	89096A	15001	86115M	HD403	86127M	XC4TF12	924027A	76064801	89550K
PPD4ME21698	89897A	420159	89780A	15003	86125M	HD404	86127M	XC4TR1	929012A	76064802	89236A
PPD4ME32603	90922A	420193	89528K	15005	86147M	HD405	86127M	XF370F2	929005A	76064986	89094A
PPD4ME32612	89887A	420198	89528K	15007	86147M	HD500	86132M	XF370M	86522M	76064987	89096A
PPD532383C1	90962A	420199	89527K	15008	86220M	HD501	86132M	XF370M1	86522M	76065597	89146C
PPD532395C1	89893A	420200	89526B	15010	86194M	HD6017	86168M	XF370M2	86522M	76066306	89784A
PPD582167C1	90823A	420200	89526K	15013	86180M	HD7034	86213M	XF370T2	929005A	76066706	89925A
PPD587519C2	90966A	420225	86125M	70003	86137M	HD7360	86685M	XF69M	86675M		SMITH™
PPD587521C2	90967A	420234	89510K	80001	20153T	HD7713	86185M	XH345MD	86184M	21396P	48210U
PPDD8HZ5246M	90938A	420256	86147M	80002	20620T	KM1105	86137M	XH360XT	925005A		SNORKEL™
SPA150	49115U	420321	86203M	81004	86132M	KM3103	86184M	XH3M1	86139M	7630695	90572A
SPA30	49130A	420365	89762K	81005	86159M	KM3105	86139M	XH404M1	86521M		STEMCO®
SPA35	49135A	420417	89664K	81006	86106M	L40030	900073A	XH466EX	926062A	1900204	86186M
SPA40	49140A	420434	89762K	81008	86153M	L40030NE	900077A	XH4AX	927010A	1900206	86187M
SPA50	49150A	420504	89537K	81010	86510M	L40060	900081A	XH4M1	86669M	1900404	86186M
SPA60	49160A	420505	89942A	81020	86510M	L40060NE	900085A	XH4TF8	929016A	1900406	86187M
	PARTEK™	420622	89763K	81021	86511M	L50030	900074A	XH4TF9	929016A	1900414	86186M
4405147	89195U	420801	86131M	90009	86132M	L50030NE	900078A	XH4TR3	929011A	1901102	86305M
	PAYHAULER™	420888	86145M	90045	86514M	L50060	900082A	XH69L2	925014A	1901107	86682M
5PP00001A	89046A	420889	86194M	94006	86133M	L50060NE	900086A	XH69R	926008A	1901125	86149M
5PP00002A	89047A	420908	89146C	94007	86213M	LK503	90979A		SHUTTLEWORTH®	1901133	86220M
	PETERBILT™	421268	89046A	94014	86180M	LK504	90980A	2220	86136M	1901138	86557M
1404055	90993A	421520	86148M	10019W	86200M	LT3550	86300M	2225	86136M	1901140	86705M
1405055	90993A	422268	89519K	10023W	86200M	LT400	86144M	2240	86518M	1901141	86655M
1409456	90081A	422342	89730K	7LT400	86144M	LT500	86150M	3250	86184M	1901144	86220M
1409456	90082A	422403	89043C	8LT400	86144M	MR200	49120B	3430	86139M	1901149	86672M
1410726	90465A	422979	89095A	9LT400	86144M	MR250	49125A	3430	86521M	1901150	86653M
1410726	90465C	424001	89099A	9LT500	86145M	MR300	49130A	3500	86188M	1901156	86213M
1411039	89514K	424002	89103A	9XD352	86113M	MR350	49135A	3590	86113M	1901157	86153M
1411054	90081A	424003	89106A	9XD356	86113M	MR400	49140A	4060	86127M	1901160	86106M
1411054	90082A	424013	89094A	9XD400	86131M	MR500	49150A	4284	86148M	1901172	86194M
1411314	86130M	424026	89094A	9XD401	86131M	MS3555	89880A	4288	86133M	1901173	86606M
1411434	90358A	425151	89501K	9XD402	86131M	OV40032	86125M	4510	86544M	1901175	86116M
1413055	900121A	426474	89187A	9XD403	86108M	OV406	86133M	4590	86132M	1901176	86116M
K16844	86108M	3420089	89238A	9XD404	86131M	OV409	86213M	5510	86130M	1901179	86655M
K16854	86531M	3420620	86133M	9XD405	86131M	OV414	86133M	5590	86102M	1901180	86139M
MFM100165	86130M	4420045	89971K	9XD406	86108M	OV449	86213M	6001	86185M	1901181	86545M
MFM100172	86130M	4420047	89097A	9XD500	86132M	TTA250	90352A	6035	86213M	1901187	86544M
MFM100295	86130M	420121001	89028A	9XD501	86132M	TTA300	90354A	6040	86153M	1901204	86526M
MFM100410	86130M	420121003	89025A	9XD502	86132M	TTA350	90355A	6289	86511M	1901205	86535M
MFM100580	86531M	420121004	89026A	9XD503	86132M	TTS300	90364A	6290	86510M	1901205	86547M
MFM100582	86196M	420121005	89029A	9XD505	86102M	TTS350	90365A	6291	86512M	1901208	86529M
MPM090141	86108M	420210003	89742K	9XD506	86102M	XD300	86139M	6440	86203M	1901208	86644M
MPM090161	86102M	4420210002	89740K	9XD508	86102M	XD4019	86133M	7440	86149M	1901220	86542M
MPM090197	86102M	SE06824	86408M	A30060PL	925051C	XD407	86131M		SICARD™	1901221	86548M
MPM100106	86130M		PRIME MOVER®	A60048PL	89224C	XD415	86127M	56005	86131M	1901223	86535M
MPM100127	86195M	3127500	86177M	A600PL	89147C	XD419	86139M	561649	86168M	1901223	86547M
MPM100338	86195M		RACINE™	AA30060PL	900088C		ROYAL™	561767	86125M	1901230	86672M
MSM090142	86108M	458764	48215U	HD200	86136M	R03782	89435E	561819	86147M	1901231	86626M
MUM090022	86108M		RAYGO™	HD201	86136M	R03536	90847A	10002214	86177M	1901934	86115M
PETTIBONE-MULLIKEN™		23570014	86153M	HD2500	86137M		SCHOOL BUS PARTS™	10002256	86132M	1908022	86183M
17765	86173M	23570018	86159M	HD2501	86137M	XB4102	929027A		SIMON-DUPLEX™	1908250	86137M
1204201	86192M	23570031	86193M	HD2502	86137M	XB4105	929007A	1004983	86168M	1909004	86186M
2318076	86192M		REX™	HD2503	86137M	XB4110	929027A	1006376	89094A	1909006	86136M
A23118051	86131M	298517292	86125M	HD25037	86137M	XB4112	929007A	1006820	89450A	1909010	86136M
A2318028	86139M	2120401292	86102M	HD2510	86137M	XB4117	929027A	1006820	89450E	1909013	86187M
L246811	86173M	2980518392	86213M	HD25739	86137M	XB4120	929007A	1007191	89046C	1909017	86136M
LA14502	49135A		RIKER®	HD271	86183M	XB452	929027A	76034174	89549K	1909022	86136M
LL32986	49125A	10006	86221M	HD27539	86506M	XB460	929027A	76050043	89528K	1909057	86136M
LL84726	86173M	10008	86544M	HD300	86187M	XB467	929027A	76052628	86125M	1909063	86137M
LL84735	86125M	10013	86118M	HD30039	86139M	XB475	929027A	76052630	86130M	1909065	86136M
LL84737	86139M	10015	86118M	HD30139	86139M	XB480	929027A	76052631	86132M	1909103	86187M
LL84786	86177M	10018	86118M	HD305	86139M	XB495	929027A	76052633	86147M	1909105	86188M

Cross Reference by Manufacturer

OEM No.	Our No.	OEM No.	Our No.	OEM No.	Our No.	OEM No.	Our No.	OEM No.	Our No.	OEM No.	Our No.
1909121	20153T	1909548	86185M	2030212	89276A	2130015	89641K	2140563	89608K	2161146	89074A
1909122	86150M	1909550	86505M	2030213	89277A	2130017	89647K	2140565	90902K	2161147	89075A
1909123	86144M	1909550	86664M	2030214	89278A	2130020	89640K	2140567	89611K	2170003	89110A
1909129	86189M	1909551	86506M	2030401	89275A	2130022	89648K	2140802	89600K	2170004	89231A
1909131	86137M	1909553	86536M	2031275	89276A	2130023	89642K	2140803	89603K	2170005	89111A
1909135	86173M	1909608	86135M	2031276	89277A	2130025	89641K	2140804	89606K	2170006	89233A
1909147	86127M	1909700	86137M	2031281	89278A	2130026	89643K	2140806	89609K	2170147	89110A
1909156	86164M	1909702	86137M	2050002	89940A	2130027	89647K	2140934	89641K	2170151	89231A
1909159	86164M	1909703	86137M	2050019	89940A	2130030	89642K	2141030	90191K	2170156	89111A
1909167	86137M	1909801	86127M	2050032	89950A	2130035	89643K	2141035	90206K	2170160	89233A
1909170	86164M	1909808	86560M	2050657	89951A	2130038	89644K	2141040	89759K	2170166	89234A
1909171	86164M	1909809	86127M	2050933	89942A	2130040	89644K	2141050	89722K	2170171	89114A
1909174	86137M	1909823	86195M	2060001	89549K	2130043	89645K	2141540	89760K	2170174	89115A
1909202	86127M	1909851	86530M	2060004	89541K	2130050	89645K	2141550	89773K	2170179	89118A
1909204	86127M	1909853	86118M	2060011	89542K	2130060	89646K	2141568	89309K	2170182	89113A
1909208	86119M	1909855	86133M	2060016	89543K	2130330	89712K	2141569	89313K	2170194	89116A
1909208	86139M	1909858	86672M	2060025	89544K	2130335	89713K	2141572	89310K	2170203	89117A
1909210	86119M	1909860	86148M	2060030	89545K	2130340	89714K	2141573	89314K	2170380	89925A
1909234	86127M	1909864	86118M	2060036	89546K	2130350	89715K	2141840	89309K	2170494	89116A
1909241	86184M	1909869	86200M	2060042	89547K	2130360	89716K	2141850	89313K	2170507	900063A
1909245	86183M	1909870	86200M	2060063	89548K	2130520	89708K	2142440	89310K	2170663	89123A
1909247	86185M	1909870	86215M	2060072	89549K	2130523	89646K	2142450	89314K	2170971	89115A
1909248	86185M	1909871	86215M	2060350	90092A	2130525	89710K	2142540	89760K	2170972	89118A
1909250	86183M	1909872	86130M	2070196	89558K	2130530	89712K	2142550	89773K	2170974	900062A
1909251	86183M	1909872	86196M	2070201	89559K	2130535	89713K	2150066	89624K	2170975	89117A
1909300	86713M	1909876	86115M	2070215	89560K	2130540	89714K	2150400	89625K	2170992	900062A
1909303	86144M	1909885	86430M	2071276	89568K	2130550	89715K	2150521	89626K	2170996	900063A
1909305	86561M	1909885	86700M	2071277	89569K	2130560	89716K	2150651	89623K	2171004	89117C
1909306	86108M	1909887	86168M	2071283	89570K	2131025	89641K	2150671	89622K	2171006	89094A
1909310	86145M	1909892	86130M	2080012	90927K	2131030	89642K	2150730	89721K	2171013	900059A
1909315	86188M	1909896	86712M	2080034	90928K	2131035	89643K	2150735	89722K	2171015	900061A
1909316	86560M	1909926	86149M	2080078	90914K	2131040	89644K	2150740	89723K	2180004	89098A
1909327	86739M	2010001	89261A	2080089	90929K	2131050	89645K	2150750	89724K	2180040	89098A
1909333	86175M	2010003	89263A	2080094	90915K	2131060	89646K	2150760	89725K	2180049	89099A
1909336	86108M	2010005	89261A	2080099	90916K	2131240	90903K	2150810	89727K	2180054	89232A
1909341	86113M	2010014	89160A	2080102	89544K	2131250	90902K	2150812	89731K	2180058	89102A
1909344	86118M	2010031	89263A	2080103	89545K	2131830	89600K	2150867	89621K	2180062	89104A
1909345	86113M	2010041	89161A	2080105	89547K	2131835	89603K	2150878	89728K	2180064	89106A
1909348	86108M	2010061	89162A	2080107	89548K	2131840	89606K	2150881	89730K	2180067	89108A
1909349	86108M	2010069	89163A	2080109	89549K	2131850	89609K	2150906	89624K	2180075	89101A
1909352	86630M	2010114	89266A	2090696	89519K	2132430	89601K	2150912	89620K	2180079	900053A
1909353	86108M	2011272	89160A	2090697	89519K	2132435	89604K	2151020	89620K	2180081	89105A
1909354	86102M	2011274	89161A	2090985	90863K	2132440	89607K	2151025	89621K	2180084	89107A
1909355	86408M	2011275	89162A	2090986	89537K	2132520	89708K	2151030	89622K	2180096	90459A
1909356	86402M	2011276	89163A	2090986	90863K	2132525	89710K	2151035	89623K	2180381	89784A
1909362	86300M	2020001	89420A	2090987	90843K	2132530	89712K	2151040	89624K	2180488	900055A
1909374	86402M	2020006	89422A	2100002	89537K	2132535	89713K	2151050	89625K	2180508	900057A
1909376	86113M	2020012	89425A	2100003	89551K	2132540	89714K	2151060	89626K	2181002	89105C
1909377	86740M	2020022	89427A	2100146	89543K	2132550	89715K	2151250	89730K	2181003	89106C
1909400	86125M	2020108	89435A	2100153	89535K	2132560	89716K	2151840	89727K	2181006	89107C
1909401	86147M	2020134	89440A	2100161	89536K	2133630	89602K	2151850	89731K	2181124	90460A
1909408	86685M	2020144	89450A	2100167	89538K	2133635	89605K	2152440	89728K	2181125	89102A
1909410	86147M	2020200	89420A	2100180	89539K	2133640	89608K	2152530	89721K	2181126	89104A
1909416	86115M	2020225	89422A	2100338	89540K	2133650	89611K	2152535	89722K	2181127	89106A
1909419	86116M	2020250	89425A	2100989	89771K	2140018	89642K	2152540	89723K	2181128	89108A
1909450	86503M	2020275	89427A	2100991	89761K	2140052	89643K	2152550	89724K	2181129	89101A
1909451	86608M	2020350	89435A	2100993	89763K	2140057	89644K	2152560	89725K	2181130	89103A
1909460	86608M	2020384	89445A	2100995	89766K	2140071	89645K	2153640	89729K	2181131	89105A
1909500	86106M	2020385	89460A	2101000	89767K	2140525	89710K	2153650	89733K	2181132	89107A
1909505	86153M	2020400	89440A	2110221	89773K	2140530	89712K	2154036	89729K	2181136	89901A
1909515	86562M	2020450	89445A	2120035	89744C	2140535	89713K	2155036	89733K	2181153	900057A
1909528	86213M	2020500	89450A	2120945	89744C	2140540	89714K	2160002	89711A	2181154	89784A
1909532	86512M	2020600	89460A	2120946	89744C	2140550	89715K	2160039	89707A	2181194	89784A
1909537	86510M	2021028	89440C	2120981	89748A	2140554	89601K	2160056	89073A	2190002	929013K
1909538	86153M	2021029	89450C	2120984	89748A	2140555	89602K	2160065	89077A	2190003	89697K
1909539	86505M	2021400	89440C	2120986	89744C	2140558	89604K	2160070	900064A	2190004	929014K
1909539	86664M	2021500	89450C	2120987	89744C	2140559	89605K	2161012	89781C	2190005	90615K
1909542	86213M	2021600	89460C	2120995	90555C	2140560	89716K	2161126	89073A	2190093	89670K
1909542	86512M	2030202	89271A	2130010	89640K	2140561	90903K	2161127	89077A	2190101	89697K
1909545	86153M	2030208	89274A	2130013	89648K	2140562	89607K	2161128	900064A	2190106	89671K

Cross Reference by Manufacturer

OEM No.	Our No.	OEM No.	Our No.	OEM No.	Our No.	OEM No.	Our No.	OEM No.	Our No.	OEM No.	Our No.
2190110	90615K	2270547	89022A	2310254	89742K	2430614	89084A	2534018	89145A	2683550	89528K
2190113	89672K	2270551	89028A	2310367	89623K	2430615	89085A	2534072	89985A	2683560	89529K
2190118	89673K	2270565	89020A	2320002	90539A	2430616	89783A	2536036	89223A	2690040	89132A
2190125	89674K	2270566	89026A	2320322	90538A	2440001	89249A	2550003	89283A	2690044	89133A
2190128	89675K	2270573	89023A	2320631	90539A	2440002	89250A	2550005	89279A	2705036	89993C
2190132	89679K	2270574	89029A	2320632	90534A	2440191	89164A	2550152	89182A	2705048	89994C
2190143	89676K	2270577	89021A	2320941	90533A	2440192	89165A	2550157	89184A	2705060	90438C
2190345	89678K	2270578	89027A	2320942	90537A	2440200	89166A	2550162	89186A	2715096	90442C
2191040	89759K	2270585	89024A	2380903	89020C	2440204	89167A	2550168	89187A	2715120	90604C
2200086	89661K	2270586	89030A	2380904	89021C	2440602	89252A	2550897	89279A	2716508	90577C
2200087	89662K	2270589	89213A	2380906	89026C	2440753	89249A	2554030	89185A	2716596	90576C
2200092	89663K	2270590	89217A	2380907	89027C	2440754	89250A	2558162	89172A	2720001	90465C
2200098	89664K	2270598	89031A	2380908	89217C	2440758	89251A	2558168	89173A	2720002	90465A
2201032	89665K	2270951	89006A	2380909	89029C	2440759	89166A	2560636	89246A	2730182	926008A
2201080	89666K	2270957	89014A	2380910	89030C	2440762	89164A	2560637	89247A	2730185	925014A
2210003	89141A	2270958	89015A	2380911	89031C	2450001	929002A	2560752	89248A	2730186	926008A
2210120	89141A	2270959	89205A	2390713	90866A	2450002	929003A	2580996	89775K	2730204	89880A
2210131	89143A	2270960	89017A	2390714	89547K	2450003	929004A	2581371	90993A	2730329	924027A
2210141	89144A	2270961	89018A	2390715	90867A	2450004	929024A	2621058	49115U	2730363	925014A
2210148	89145A	2270962	89019A	2390716	90868A	2450724	929004A	2621059	49120B	2730364	926008A
2210154	89146A	2276136	89219A	2390728	89550K	2450726	89685K	2621060	49125A	2730399	924005A
2210696	89144A	2280806	929005A	2400749	89256A	2450726	929025A	2621061	49130A	2730409	926062A
2210697	89145A	2280841	929026A	2400860	89881A	2450728	89686K	2621062	49135A	2730416	926008A
2210698	89146A	2280865	929016A	2400865	89883A	2450729	89687K	2621063	49140A	2730417	924004A
2218000	89147A	2280873	929005A	2420982	90450C	2450730	929007A	2621064	49150A	2730418	925005A
2220003	89151A	2280937	929003A	2421144	89146C	2450732	89688K	2621065	49160A	2730419	89600K
2220119	89151A	2280951	929016A	2421281	89155C	2450962	89019A	2622015	49115U	2730422	926062A
2220124	89153A	2280952	929016A	2421282	89145C	2451231	929002A	2622020	49120B	2730423	924008A
2220130	89154A	2280959	89205A	2421283	89156C	2451261	929002A	2622025	49125A	2730424	926008A
2220133	89155A	2280960	926005A	2421285	89053C	2451262	929003A	2622030	49130A	2730429	90966A
2220136	89156A	2280964	929011A	2421287	89056C	2451282	89698K	2622035	49135A	2730430	89603K
2220967	89155A	2280965	929011A	2421291	89054C	2458005	929035S	2622040	49140A	2730431	90967A
2220979	89154A	2280966	929011A	2421292	89045C	2458006	929036S	2622050	49150A	2730494	89892A
2220981	90913A	2280968	929011A	2421293	89057C	2458015	929005A	2622060	49160A	2740016	90823A
2220984	89153A	2280969	929011A	2421295	89060C	2458729	929035S	2680005	89525W	2740020	89897A
2220985	89043A	2280970	929011A	2421296	89222C	2458732	929036S	2680006	89526W	2740021	90922A
2220989	89156A	2281013	929026A	2421297	89226C	2500001	89508K	2680007	89527W	2740022	89887A
2240164	89045A	2281066	925002A	2421299	89227C	2500002	89509K	2680008	89528W	2740032	90913A
2240176	89044A	2281069	929012A	2421300	89293C	2500004	89531K	2681420	90350A	2740064	90938A
2240463	89047A	2281099	929007A	2421301	89985C	2500013	89532K	2681425	90352A	2740072	90983A
2240470	89048A	2281154	929007A	2421302	89296C	2500014	89502K	2681427	90353A	2740122	90451A
2240762	89164A	2281159	924037A	2421303	89988C	2500016	89512K	2681430	90354A	2740123	90451C
2240878	89222A	2281160	924037A	2421304	89294C	2500017	89520K	2681435	90355A	2740124	90452A
2240880	89049A	2281172	924037A	2421305	89986C	2500020	89571K	2681450	90358A	2740125	90452C
2240882	89043A	2281177	926011A	2421307	89989C	2500021	89530K	2681522	90361A	2740126	90444A
2240883	89046A	2281180	924037A	2421308	89295C	2500022	89573K	2681527	90363A	2740127	90444C
2244018	89155A	2281180	929004A	2421309	89987C	2500023	89520K	2681530	90364A	2740148	90979A
2244072	89293A	2281183	929011A	2421310	89298C	2500638	89511K	2681535	90365A	2740150	90980A
2245072	89296A	2281193	927010A	2421311	89990C	2500639	89512K	2681545	90367A	2740165	900065A
2250205	89959K	2281194	929001A	2421317	900089C	2500640	89513K	2681550	90368A	2740176	90981A
2250207	89961K	2281197	929016A	2421402	89043C	2500900	89505K	2681560	90369A	2740190	900121A
2250943	89967K	2281198	929016A	2421403	89055C	2500901	89506K	2681825	90352A	2740201	89899A
2250944	89964K	2281202	926072A	2421404	89046C	2500902	89507K	2681830	90354A	2740268	924037A
2251094	89971K	2281239	923042A	2421405	89058C	2500930	89500K	2681835	90355A	2740271	90987A
2251095	89955K	2281256	924005A	2426018	89147C	2500931	89503K	2681850	90358A	92622025	49125A
2251096	89958K	2281282	925005A	2426036	89228C	2500970	89514K	2681930	90364A	92622030	49130A
2251097	89960K	2290220	89091A	2426136	89223C	2501017	89510K	2681935	90365A	92622035	49135A
2251254	89965K	2290224	89093A	2426148	89224C	2501278	89501K	2681950	90368A	92622040	49140A
2251259	89966K	2290227	89095A	2426596	90449C	2501280	90531K	2682430	90374A	92622050	49150A
2251260	89963K	2290229	89097A	2430001	89082A	2508001	89533K	2682435	90375A		
2251262	89959K	2290232	900082A	2430002	89081A	2520846	89017C	2682440	90376A	40009	86177M
2251263	89967K	2290660	89236A	2430003	89240A	2520848	89019C	2682450	90378A	40282	86150M
2251264	89958K	2291610	900081A	2430005	89086A	2530189	89057A	2682460	90379A	41751	86172M
2251265	89962K	2291735	900073A	2430263	89081A	2530198	89056A	2683520	89521K	42993	89435A
2270253	89211A	2298024	900077A	2430266	89240A	2530466	89059A	2683522	89522K	42993	89435E
2270257	89214A	2298026	900085A	2430273	89082A	2530468	89060A	2683525	89523K	43305	86213M
2270260	89216A	2298036	900078A	2430278	89083A	2530894	89226A	2683527	89524K	44308	89422A
2270271	89218A	2298037	900069A	2430283	900068A	2530896	89227A	2683530	89525K	45344	89425A
2270542	89025A	2298038	900086A	2430286	89782A	2530976	89055A	2683535	89526K	45564	86173M
2270544	89212A	2310240	89740K	2430492	89782A	2530977	89058A	2683540	89527K	49540	86213M

SULLAIR®

Cross Reference by Manufacturer

OEM No.	Our No.	OEM No.	Our No.	OEM No.	Our No.	OEM No.	Our No.	OEM No.	Our No.	OEM No.	Our No.
241135	49125A	TOWMOTOR®		8975	89164A	9662	90352A	10681	89923A	24750	89046A
241819	49135A	680400	86137M	8976	89165A	9663	90353A	10683	89131A	24752	89600K
245525	86191M	680401	86168M	8978	89167A	9667	90363A	10684	89132A	24753	89603K
407349	49150A	680402	86125M	8979	89252A	9668	90364A	10685	89133A	24754	89731K
250008043	49130A	TRUCKEX™		8982	89721K	9669	90365A	10727	89074A	24755	89609K
250021777	49120B	2704	86139M	8983	89722K	9670	90367A	10732	89075A	24835	89607K
2250091785	49150A	2958	86164M	8984	89640K	9671	90369A	10733	89076A	24836	89728K
SULLIVAN™		3150	86184M	8985	89641K	9678	90375A	10741	89242A	24849	89604K
19002480004	89440E	3424	86675M	8986	89642K	9686	90382A	10745	89084A	24850	89618K
SUPERIOR DIESEL™		3610	86185M	8987	89643K	9692	90386A	10746	89783A	24936	89797K
SD2492	89237A	3611	86512M	8988	89644K	9693	90387A	10747	89085A	24939	89040A
TAYLOR MACHINE™		3614	86125M	8990	89646K	9722	89185A	10755	89239A	24941	89212A
2403031	86139M	3625	86127M	8991	89166A	9726	89786K	10757	89101A	28495	89211A
2403034	86131M	3632	86153M	9331	89187A	9727	89787K	10758	900052A	34673	89729K
2403036	86175M	3647	86147M	9332	89186A	9728	89788K	10759	89103A	34674	89733K
2403037	86125M	3654	86137M	9333	89184A	9729	89789K	10762	89106A	34713	89020A
2403044	86108M	3655	86139M	9335	89278A	9734	89550C	10763	90463A	34714	89023A
2403054	86200M	3663	86135M	9336	89283A	9735	89510K	10764	89924A	34715	89026A
2403107	86115M	3666	86108M	9353	86147M	10301	89098A	10765	89107A	34716	89029A
2403348	86119M	3668	86213M	9354	89640K	10302	89230A	10773	89110A	34719	89056A
2403748	89195U	3697	86183M	9355	89535K	10303	89099A	10774	89111A	34720	89059A
2493031	86139M	3699	86682M	9356	89538K	10304	89102A	10775	89233A	34723	89044A
7800027	86192M	3700	86502M	9358	89540K	10305	89104A	10776	89090A	34743	89607K
TEREX®		3708	86557M	9359	89551K	10306	89106A	10778	89234A	34744	89311K
125663	86139M	3710	86505M	9360	89537K	10308	89108A	10781	89094A	34785	89605K
125689	89435E	3711	86653M	9362	90903K	10309	89118A	10785	89126A	34786	89619K
265772	86190M	3712	86740M	9363	90076A	10313	89073A	10788	89926A	34799	924037A
1240228	89546K	3713	86529M	9365	90079A	10314	89077A	10789	89096A	34827	89053A
2793505	89519K	3716	86536M	9366	90080A	10315	89780A	10790	89123A	34828	89037A
4204753	86187M	3719	86722M	9383	89523K	10318	89243A	10791	900062A	34879	923042A
4607688	89056C	3725	86522M	9384	89525W	10320	89241A	10792	89119A	44656	89027A
4607689	89527K	3851	86755M	9386	89527W	10330	89236A	10793	89232A	44657	89015A
4619365	89215A	3898	86115M	9387	89528W	10337	89091A	10794	89092A	44658	89030A
7095969	89430E	4236	86543M	9395	89505K	10338	89093A	10921	89150A	44659	89018A
7120512	89167A	8052	90843K	9396	89506K	10339	89095A	14337	89261A	44664	89057A
9013928	86147M	8300	929016A	9398	89511K	10340	89097A	14338	89263A	44665	89045A
9214205	49160A	8483	89519K	9399	89513K	10534	89113A	14343	89151A	44666	89060A
84000778	89050A	8856	89759K	9479	89508K	10535	89235A	14601	89160A	44667	89048A
84000778	89050C	8857	89772K	9486	89548C	10536	89114A	14602	89161A	44731	89024A
206466700	89569K	8868	89708K	9487	89549C	10537	89115A	14603	89162A	44773	924027A
THERMO KING™		8870	89709K	9490	89566K	10538	89925A	14605	89163A	44853	89042A
118055	89559B	8872	89710K	9492	89568K	10539	89116A	14618	89143A	44854	89021A
916185	89559B	8877	89715K	9493	89569K	10540	89117A	14619	89144A	48348	923008A
916185	89559K	8878	89723K	9495	89570K	10553	90459A	14620	90909A	48349	924004A
1B17070G01	89556K	8879	89724K	9501	89556K	10555	90460A	14654	89152A	54720	89031A
9175C42G01	89559K	8880	89712K	9502	89557K	10556	89109A	14737	89730K	54721	89226C
9197C92G01	89559B	8881	89713K	9503	89558K	10557	89924A	14738	90903K	54722	89143C
THOMAS BUILT BUSES®		8882	89714K	9504	89559K	10560	90465A	14740	90902K	54725	89222A
61240005	86147M	8883	89620K	9506	89560K	10562	89082A	24344	89153A	54726	89049A
61240007	86115M	8884	89621K	9580	89536K	10564	89083A	24345	89154A	54809	925002A
61240008	86125M	8885	89622K	9599	89214A	10565	89087A	24346	90913A	54880	924037A
61240207	89531K	8886	89623K	9600	89182A	10566	89782A	24654	89796K	54984	89205A
61240386	90910A	8887	89624K	9604	90354A	10620	89105A	24674	89794K	54985	89019A
61370302	89545K	8888	89625K	9605	90355A	10631	900072A	24675	89613K	54991	89217A
65004938	89145A	8906	89249A	9607	90358A	10632	900073A	24676	89617K	58251	925014A
141527A	90363A	8933	89249A	9612	89500K	10633	900074A	24677	89727K	58330	924008A
141830A	90374A	8942	89279A	9613	89512K	10635	900076A	24696	89147A	58349	925005A
141930A	90354A	8943	89250A	9614	89533K	10636	900077A	24697	89157A	58420	925070A
142640A	90376A	8953	89271A	9615	89503K	10637	900078A	24711	89216A	64673	89985A
143150A	90358A	8955	89274A	9618	89571K	10639	900080A	24712	89218A	68221	926008A
TIMBERJACK™		8956	89275A	9619	89532K	10640	900081A	24713	89145A	74607	926005A
700353600	86144M	8957	89276A	9622	89531K	10641	900082A	24714	89146A	74632	927010A
700587300	89519K	8958	89277A	9627	89501K	10643	900084A	24717	89155A	74646	926072A
700623400	86133M	8960	89168A	9628	900005A	10644	900085A	24718	89156A	83005	929011A
810367400	89548K	8962	89170A	9648	89881A	10645	900086A	24735	89022A	83008	929012A
TORO®		8964	89172A	9649	89256A	10671	900046A	24737	89025A	83014	929001A
2873	48111U	8965	89173A	9650	89883A	10674	900050A	24739	89028A	83016	924005A
		8972	89247A	9653	89520K	10675	89101A	24745	89052A	83029	929038A
		8973	89248A	9654	90531K	10678	900056A	24746	89055A	83030	929027A
		8974	89266A	9660	90350A	10680	89784A	24747	89058A	84552	929011A

Cross Reference by Manufacturer

OEM No.	Our No.	OEM No.	Our No.	OEM No.	Our No.	OEM No.	Our No.	OEM No.	Our No.	OEM No.	Our No.	
809406	89106C	400A1016	89687K	VERSATILE®				717954A	86187M	21832	86512M	
809546	89107C	400A1414	929007A	61620	48215U	3919775	89549K	816782A	86189M	21833	86118M	
809547	89784C	400C1016	89674K	260424V11	86177M	3919776	89559B	G15571897	21063A	21835	86145M	
809736	89780C	400S1016	929035S	606T122	86178M	3919777	89744C	G2079904	18306A	21837	86133M	
809738	89781C	412A1016	89678K	606T123A	86135M	3919779	89749C	WABCO™				
809739	89075C	500A1016	89688K	VOGELE™				CL1352	86173M	21923	86115M	
809770	89105C	500C1016	89675K	506959	90904A	3919782	89784A	HW0449	86131M	21925	86164M	
809771	89924C	500S1016	929036S	VOLKSWAGON™				KC3015	86178M	21968	86151M	
809796	89117C	512A1016	89679K	125253190M	86190M	3919783	89924A	MB0715	49150A	21969	86148M	
814621	89143C	600A1016	89698K	VOLVO™				PB3205	86147M	21970	86152M	
814622	89144C	AS400	90875A	700710	89058C	3919785	86131M	SP5201	86125M	21971	86149M	
814623	90909C	AS500	90877A	700745	89056A	3919787	86137M	WALDON EQUIPMENT™				
824002	89052C	B200	89521K	700746	89059A	3946774	90388A	414714	86192M	22004	86153M	
824701	89218C	B212	89523K	700747	89045C	3946774	90388B	WALKER®				
824715	89145C	B214	89522K	700748	89060C	3946776	90386A	21003	86136M	22020	14490T	
824716	89146C	B300	89525K	700752	89056C	3946776	90386B	21004	86137M	22022	14472T	
824721	89155C	B312	89526K	700757	89950A	3946777	90368A	21007	86136M	22025	11650T	
824722	89156C	B400	89527K	700757	89950C	3946777	90368B	21018	86139M	22033	10156T	
824749	89043C	B412	90464K	700758	89027A	3946778	90366B	21021	86132M	22034	11731T	
824751	89046C	B500	89528K	700760	89030A	3946779	86131M	21022	86136M	22041	18901T	
824757	89055C	B600	89529K	700761	89027C	3946780	86682M	21028	86136M	22095	14663T	
824758	89058C	CLV400	90907K	700763	89030C	3948169	900356S	21030	86137M	22100	86675M	
834000	89053C	H200	90929K	700768	49140A	3948308	89049A	21040	16487T	22214	86510M	
834004	89026C	H212	90916K	700870	89055C	3948357	89727K	21057	22152T	22226	86173M	
834005	89029C	H234	89544K	701062	89166A	3970714	86531M	21060	14245T	22231	86185M	
834708	89017C	H300	89545K	717976	89143A	3973651	27023A	21061	13900T	22235	86186M	
834725	89036C	H300P	900041K	816839	89214A	8022803	24809A	21069	86756M	22337	86503M	
834746	89056C	H312P	90867A	816840	89216A	8060101	89535K	21070	86570M	22356	86186M	
844002	89021C	H400P	900043K	835866	86132M	8060103	86188M	21071	86607M	22390	11669T	
844004	89030C	T234	89544K	836841	89106A	8060123	89547K	21072	86755M	22391	86511M	
844668	89057C	T300Z	89545K	837246	89714K	8070241	86535M	21073	86754M	22449	86505M	
844669	89045C	T312Z	89547K	857256	89104A	8070241	86547M	21074	86548M	22449	86664M	
844670	89060C	T314	89546K	857264	89151A	20354705	86117A	21083	86751M	22533	15572T	
844734	89051C	T400Z	89548K	857278	89015A	20387751	28071A	21084	86757M	22534	21326A	
844735	89054C	T412Z	90092A	857415	89162A	27076551	86300M	21088	86744M	22536	22150T	
844737	89037C	T500Z	89549K	857482	89161A	27138775	86148M	21124	86136M	22538	86556M	
854000	925051C	T660Z	89550K	857585	89105A	49014271	86108M	21125	86137M	22551	86536M	
854002	89027C	U112	90927K	857613	89055A	49014272	86108M	21126	86136M	22552	86147M	
854716	89019C	U134	90928K	858622	89277A	49033350	86102M	21127	86136M	22555	86220M	
854723	89226C	U178	90914K	858623	89276A	49034554	86102M	21155	86137M	22566	86722M	
854724	89227C	U200	90929K	858626	89163A	49039300	86102M	21169	86136M	22570	86562M	
854727	89222C	U212	90916K	858630	86144M	230010005	86108M	21174	86125M	22571	86561M	
864000	89293C	U214	90915K	858639	89048A	230010010	86200M	21188	86177M	22572	86560M	
864001	89296C	UNIVERSAL COACH PARTS™			858640	89108A	230010027	86125M	21260	86135M	22604	86537M
864671	89985C	689398	12036A	858641	89077A	230010031	86116M	21287	86136M	22630	86173M	
864672	89988C	693299	86164M	858642	89074A	230010035	86115M	21325	86136M	22632	86106M	
874000	89294C	100703005	19141N	858643	89075A	230010040	86108M	21328	86137M	22642	86725M	
874001	89298C	394202247	86757M	858647	89187A	230010044	86130M	21331	86136M	22643	86724M	
874608	89986C	VECTOR™				858648	89186A	230010053	86116M	21365	86137M	
874609	89989C	44921	89430E	891137	89715K	230010062	86115M	21372	86136M	22664	86530M	
884000	89295C	VERMEER®				892851	900356S	230010076	86547M	21464	86723M	
884001	90526C	2572001	89153A	892940	89057C	230010080	86531M	21465	86133M	22668	86698M	
884548	89987C	73162052	89571K	1007751	89766K	230010083	86196M	21467	86150M	22669	86697M	
884550	89990C	902455001	89427A	1020649	89156A	230010084	86196M	21468	86187M	22715	86690M	
924120	90906A	906020011	89624K	1025552	86132M	230013209	86606M	21470	86188M	22765	86172M	
200A1014	929002A	938690011	89151A	1111110	86682M	230013220	22286A	21471	86189M	22767	86192M	
200K1014	929013K	938780011	86191M	1116639	86526M	230013222	86753M	21473	86178M	22768	86193M	
200K1016	89670K	1026239191	89687K	2013323	86526M	230013430	86531M	21475	86137M	22774	49160A	
212A1014	929004A	1037310011	89050C	3086612	89198U	230013823	22833A	21476	86139M	22789	86653M	
212K1014	929014K	1225720011	89153A	3130895	89731K	230018001	23557A	21495	86136M	22809	86131M	
214A1014	929003A	1252380011	89430E	3919708	90358A	230018002	23558A	21540	86137M	22822	86135M	
214K1016	89697K	2032510011	49140A	3919766	86526M	235095001	89107A	21578	49120B	22823	86132M	
234A1014	929024A	2140870011	89055A	3919767	89107A	235200005	90354A	21579	49125A	22828	86108M	
234A1414	929005A	2408030011	89101A	3919768	89103A	235200006	90355A	21580	49130A	22829	86102M	
234C1016	90615K	2447680011	90913A	3919769	89107A	235200008	90358A	21581	49135A	22835	86200M	
300A1016	89685K	2408020011	89612K	3919770	89145A	235200014	90547K	21582	49140A	22843	86203M	
300A1414	929005A	2408030011	89101A	3919771	89145C	235200015	90546K	21584	49150A	22844	86113M	
300K1014	929015K	9047570011	89052A	3919772	89146C	80998441650	90358A	21723	86186M	22851	86130M	
312A1016	89686K			3919773	89527K	80998441650	90358B	21745	86137M	22852	86164M	
400A1014	929027A			3919774	89528K	447803A	86147M	21752	86300M	22861	11026T	

Cross Reference by Manufacturer

OEM No.	Our No.	OEM No.	Our No.	OEM No.	Our No.	OEM No.	Our No.	OEM No.	Our No.	OEM No.	Our No.
22865	86184M	29410	89021C	35406	90928K	35855	89535K	41222	89093A	41638	900059A
22866	86183M	29411	90452C	35407	90914K	35856	89538K	41223	89095A	41639	89780A
22867	11731T	29501	89019C	35408	90929K	35885	89771K	41224	89097A	41646	89955K
22879	17704T	29502	89222C	35413	90915K	35886	89761K	41250	89141A	41647	89958K
22888	86502M	29505	925051C	35414	90916K	35887	89762K	41251	89105A	41649	89963K
22896	86514M	29506	89217C	35422	89525W	35898	90843K	41252	89103A	41650	89960K
22897	86557M	29507	89031C	35423	90464K	35899	900005A	41256	89094A	41652	89964K
22899	86529M	29508	89226C	35424	90092A	35907	89440A	41365	89101A	41653	89965K
22899	86644M	29509	89227C	35442	89771K	35909	89445A	41366	89103A	41654	89966K
22904	18202T	29510	89298C	35444	89566K	35910	89450A	41367	89105A	41655	89967K
22905	14663T	29511	90438C	35445	89546K	35931	89440C	41378	89105A	41656	89956K
22907	86180M	29512	90444C	35449	89511K	35932	89450C	41428	89083A	41658	89961K
22908	89996C	29600	89985C	35456	89548C	35933	89763K	41429	89087A	41659	90567A
22914	86624M	29602	89920C	35457	89549C	35934	89525W	41429	900068A	41663	89958K
22915	86526M	29603	89988C	35495	89508K	35935	89763K	41430	89782A	41685	89909A
22916	86544M	29604	89296C	35496	89501K	35936	89526W	41431	89783A	41686	89780A
22917	86194M	29605	89293C	35497	89550C	35937	89527W	41432	89111A	41688	89971K
22920	86682M	29701	89989C	35498	89533K	35938	89528W	41433	89233A	41692	90903K
22924	86531M	29702	89986C	35499	89509K		900273A	41434	89113A	41693	89730K
22925	86196M	29800	89987C	35500	89514K		(Upgrade)	41435	89114A	41694	90902K
22932	86695M	29801	89990C	35512	89420A	35961	89527B	41435	900058A	41696	89967K
22936	86713M	29802	90442C	35513	89422A	35972	89539K	41436	89117A	41763	89230A
22937	86547M	29804	90449C	35514	89425A	35975	89528K	41436	900062A	41889	89252A
22938	86626M	29805	90576C	35520	89531K	35976	89527K	41438	89082A	41890	89881A
22940	86739M	29806	89295C	35606	90076A	35977	89526K	41439	89243A	41891	89256A
22941	86740M	29807	89298C	35617	89427A	35978	89525K	41440	89242A	41892	89160A
22943	86753M	29900	900089C	35619	89435A	35979	89523K	41441	89099A	41893	89161A
22944	86606M	29901	90526C	35620	89521K	35980	89529K	41442	89232A	41894	89276A
22962	86773M	29902	90450C	35621	89522K	35983	89540K	41472	89105A	41895	89162A
29040	89748A	29903	90579C	35622	89524K	35984	89551K	41473	89116A	41896	89166A
29041	89744C	29905	90577C	35624	89556K	40005	89708K	41480	90538A	41897	89167A
29043	89748A	29906	90578C	35640	89532K	40006	89709K	41515	89883A	41898	89277A
29043	89748A	31246	90822A	35641	89507K	40007	89710K	41532	89784A	41899	89163A
29044	89996C	33221	90363A	35658	89502K	40008	89712K	41534	89102A	41902	89249A
29045	89744C	33222	90364A	35664	89962K	40009	89712K	41534	900052A	41909	89173A
29046	89749C	33223	90365A	35683	89958K	40010	89713K	41535	89101A	41940	89261A
29047	90856C	33225	90368A	35690	89500K	40011	89714K	41536	89090A	41944	89249A
29048	89749C	33959	89525B	35692	89570K	40012	89715K	41537	89092A	41947	89249A
29052	89748A	33960	89526K	35693	89560K	40020	89721K	41538	89126A	41957	89263A
29101	89155C	33961	89527B	35695	89505K	40021	89722K	41539	90533A	41963	89279A
29102	89156C	33962	89528B	35696	89557K	40022	89723K	41540	90539A	41965	89250A
29108	89924C	33964	89524K	35733	89537K	40023	89724K	41557	89266A	41969	89160A
29109	90847C	33966	90353A	35734	90080A	40024	89713K	41558	89098A	41970	89164A
29110	89775K	33967	90354A	35746	89510K	40025	89714K	41560	89119A	41972	89182A
29111	89145C	33968	90355A	35747	89971K	40026	89715K	41583	89236A	41973	89271A
29112	89146C	33969	90369A	35753	90867A	40247	89940A	41603	90938A	41974	89168A
29113	89780C	33970	90358A	35757	90868A	40256	89941A	41612	900069A	41976	89164A
29200	89781C	33971	90350A	35760	89546K	40257	89951A	41614	900076A	41977	89161A
29201	89043C	33973	90352A	35772	90866A	40364	89950A	41615	900077A	41978	89165A
29202	89046C	35036	89520K	35773	89547K	40577	90993A	41616	900078A	41979	89246A
29205	89052C	35103	89519K	35774	90867A	40590	900121A	41618	900072A	41980	89184A
29206	89055C	35194	89440A	35776	89568K	41001	89098A	41619	900073A	41981	89274A
29207	89058C	35195	89450A	35777	89569K	41001	900046A	41620	900074A	41982	89170A
29208	90451C	35216	89766K	35784	89955K	41002	89099A	41622	900084A	41983	89165A
29209	90465C	35227	90875A	35785	89960K	41002	900048A	41623	900085A	41984	89172A
29210	89107C	35228	90877A	35786	89545K	41003	89101A	41624	900086A	41985	89162A
29211	89106C	35290	89520K	35787	89547K	41004	89103A	41626	900080A	41986	89166A
29212	89784C	35291	89526W	35788	89548K	41005	89105A	41627	900081A	41987	89247A
29214	90452C	35292	89527W	35789	89549K	41094	89151A	41628	900082A	41988	89185A
29242	89748A	35293	89528W	35790	89762K	41095	89153A	41629	89116A	41989	89275A
29248	89748A	35304	89543K	35791	89763K	41096	89154A	41629	900062A	41990	89276A
29301	89993C	35332	90531K	35795	89550K	41097	89155A	41630	89923A	41991	89186A
29303	89109C	35343	90928K	35796	89518K	41097	90913A	41631	89110A	41992	89248A
29304	89053C	35344	90914K	35799	89558K	41099	89232A	41632	89782A	41993	89167A
29305	89056C	35348	90857K	35800	89559K	41099	900050A	41633	89103A	41994	89187A
29310	89017C	35354	90916K	35804	89506K	41154	89098A	41634	89923A	41995	89277A
29402	89045C	35370	89767K	35805	89513K	41187	89071A	41635	89105A	41996	89163A
29405	89994C	35372	90857K	35806	89503K	41204	89132A	41636	89090A	41997	89283A
29408	89057C	35393	89460A	35807	49115U	41217	89133A	41637	89092A	41998	89278A
29409	89060C	35401	89500K	35853	90079A	41221	89091A	41638	89116A	42065	89600K

Cross Reference by Manufacturer

OEM No.	Our No.	OEM No.	Our No.	OEM No.	Our No.	OEM No.	Our No.	OEM No.	Our No.	OEM No.	Our No.
42066	89603K	42944	89109A	47645	927010A	52033	90987A	49039300	86102M		
42067	89606K	42944	900057A	47960	929002A	53017	90979A	49039302	86145M		
42068	89609K	42978	89897A	47961	929003A	53018	90980A	49039303	86195M		
42069	89607K	43049	89901A	47962	929004A	53027	924037A	49039308	86200M		
42071	89055A	43132	89040A	47972	929002A	53053	89053A	49044073	86130M		
42072	89058A	43168	90459A	47973	929003A	55057	925070A	49045022	86130M		
42125	89123A	43196	924037A	47974	929004A	55057	925071A	49046994	86215M		
42125	900061A	43202	89729K	47976	929002A	55063	925068A	49047016	86200M		
42126	89218A	43203	89733K	47977	929003A	55067	925068A	230010002	86108M		
42127	89214A	43233	89892A	47978	929004A	WARNER & SWASEY™		230010003	86200M		
42128	89147A	43277	923008A	47984	89670K	24921330	86139M	230010004	86102M		
42129	89155A	43319	89026A	47986	89697K	76009164	86173M	230010005	86108M		
42130	89156A	43320	89056A	47987	929014K	76018489	49130A	230010010	86200M		
42147	89123A	43321	89059A	47988	929013K	76020614	86177M	230010027	86125M		
42175	89794K	43324	923042A	47989	929013K	76022356	86139M	230010040	86108M		
42177	89796K	43348	89107A	47993	89670K	76026291	86147M	230010041	86130M		
42178	89212A	43362	90922A	47995	89697K	76032138	86133M	230010044	86130M		
42185	89104A	43366	89023A	47996	929014K	85071213	86173M	230010047	86195M		
42186	90983A	43381	89608K	49003	90615K	86571017	49140A	230010051	86203M		
42246	89074A	43382	89311K	49006	89670K	86681083	86136M	230010052	86200M		
42247	89084A	43438	90460A	49007	89697K	DA81670	86147M	230010064	86130M		
42249	89085A	43467	90823A	49008	929014K	WESTERN STAR®		230013409	86195M		
42252	89239A	43582	89029A	49009	90615K	230013215	86196M	230013410	86130M		
42253	89926A	43587	90451A	49010	929015K	230013427	86130M	230013411	86130M		
42272	89107A	43588	90452A	49011	929022K	230013429	86196M	230013417	86195M		
42274	89117A	43601	89104A	49012	929023K	230013430	86531M	230013420	86130M		
42288	89114A	43602	89106A	49015	89675K	230013431	86712M	230013807	86130M		
42317	89797K	43606	89020A	49016	929013K	230013432	86700M	303148904	89435E		
42336	89780A	43668	89076A	49024	89670K	235043432	90887A	303327701	89440E		
42336	900064A	43698	89115A	49025	89697K	235273440	900123A	303345440	89430E		
42338	89728K	43699	89118A	49026	929014K	235283472	89198U	949044343	86195M		
42344	89234A	43718	89044A	49027	89676K	H5825101	89542K	10A18924	89440E		
42377	89146A	43719	89047A	49028	89642K	H5825102	89543K	160907A	86190M		
42423	89727K	44095	924004A	49029	89643K	WHITE™		7GB010	86108M		
42424	89731K	44112	89125A	49030	89644K	447803	86125M	816782A	86189M		
42445	89102A	44126	89027A	49031	89645K	508708	86139M	A0412967	86130M		
42447	90909A	44127	89030A	49032	89622K	517485	86147M	WHITING™			
42448	89143A	44132	924005A	49033	89623K	537890	86147M	9243	86513M		
42449	89144A	44154	924008A	49034	89624K	539585	86125M	ST7410136	86213M		
42451	89073A	44200	924005A	49035	89625K	545115	86131M	WINCO™			
42452	89077A	44203	89887A	49036	89646K	545854	86108M	48423000	48210U		
42453	89075A	44299	89057A	49037	89647K	549340	86147M	WINNEBAGO™			
42455	89617K	44300	89060A	49040	90615K	552249	86132M	128903	89187A		
42478	89141A	44301	89021A	49041	929015K	629780	86108M	11642501	90910C		
42492	89613K	44302	89037A	49043	929013K	649297	86108M	WINPOWER™			
42500	89924A	44456	89015A	49044	89621K	651360	86125M	EN164	86173M		
42530	89028A	44457	89018A	49047	929002A	675490	86139M	WIS-CON™			
42531	89025A	44557	924037A	49048	929003A	835866	86108M	26020229	90368B		
42543	89046A	44569	89109A	49049	929004A	998580	86108M	WISCONSIN™			
42544	89043A	44634	89042A	49050	929005A	23001056	86130M	26020230	89016C		
42562	900063A	44637	89045A	49052	929007A	27076523	86119M	WORTHINGTON™			
42606	89211A	44638	89048A	49056	89678K	27076528	86119M	MUF20006	86177M		
42715	89145A	45066	89217A	49060	89620K	27076530	86512M	MUF57	86173M		
42716	89146A	45076	925005A	49062	89698K	27076535	86203M	YALE™			
42758	89780A	45233	89226A	49063	89626K	27076537	86133M	50174500005	89435E		
42758	900064A	45247	90444A	49064	89688K	27076541	86125M	YANMAR™			
42760	89073A	45320	89893A	49065	929025A	27076544	86132M	12908713530	89420A		
42761	89077A	45327	926062A	49066	929015K	27076545	86200M	12908713540	89541K		
42763	89924A	45339	89205A	49067	929024A	27076551	86300M				
42855	89075A	45340	89019A	49068	929003A	27137738	86200M				
42855	900065A	45455	89617K	49070	89759K	27138775	86148M				
42856	90465A	45726	89222A	49071	89772K	49014270	86108M				
42857	89115A	45727	89049A	49151	929011A	49014271	86108M				
42858	89107A	45779	89880A	49159	929025A	49014272	86108M				
42891	89216A	45946	925014A	49160	929026A	49014273	86108M				
42936	89925A	46588	926005A	49161	929027A	49033350	86102M				
42937	89106A	46670	926008A	49162	89688K	49034554	86102M				
42938	89108A	46736	926011A	49165	929016A	49037185	86200M				
42939	89117A	46778	89031A	49166	929001A	49037199	86102M				
42940	89118A	46821	926072A	49177	929038A	49037855	86115M				

Cross Reference by Number

Manufacturer's Abbreviations

All information in this cross reference is as accurate as possible at the time of this printing. The manufacturer cannot guarantee accuracy nor be responsible for any misapplication.

This cross reference allows you to look up an OEM part number and find the corresponding Nelson Global Products part. The following manufacturer's abbreviations are used in this section:

AMGENRL	A M GENERAL™	FORD	FORD™	NORTHAME	NORTH AMERICAN BUS™
AGCHEMEQ	AG CHEM EQUIPMENT®	FREIGHTL	FREIGHTLINER®	NORTHWEN	NORTHWEST
AGCO	AGCO™	FWD	FWD™		ENGINEERING™
ALLIEDSY	ALLIED SYSTEMS™	GALION	GALION™	NOVABUS	NOVABUS™
ALLISCHA	ALLIS-CHALMERS™	GARDNERD	GARDNER-DENVER™	OLIVER	OLIVER™
AMERHOIS	AMERICAN HOIST &	GEHL	GEHL®	ONAN	ONAN™
	DERRICK™	GENERAC	GENERAC®	ORENSTEI	ORENSTEIN-COPPEL™
AMERLAFR	AMERICAN LAFRANCE™	GENIE	GENIE®	ORIONBUS	ORIONBUS™
OHIOLCRN	AMERICAN & OHIO	GILL	GILL™	OSHKOSH	OSHKOSH™
	LOCOMOTIVE CRANE CO.™	GILLIG	GILLIG CORP.	OTTAWA	OTTAWA™
AP	AP™	GMC	GMC™	PACCAR	PACCAR™
ARIENS	ARIENS®	GOERLICH	GOERLICH®	PAR FOR	PAR FOR™
ATHEY	ATHEY™	GORMANRU	GORMAN-RUPP®	PARTEK	PARTEK™
ATLASCP	ATLAS™	GRADALL	GRADALL®	PAYHAULE	PAYHAULER™
AUTOCAR	AUTOCAR™	GRIMMERS	GRIMMER SCHMIDT™	PETERBIL	PETERBILT™
BALD	BALDWIN™	GROVE	GROVE®	PETTIBON	PETTIBONE-MULLIKEN™
BIGRIG	BIG RIG™	HENDRICK	HENDRICKSON®	PIERCEO	PIERCE®
BILNGSLY	BILLINGSLY™	HERCULES	HERCULES™	PIVOTPWR	PIVOT POWER™
BLAWKNOX	BLAW-KNOX™	HOBART	HOBART™	PLY LOCO	PLYMOUTH LOCOMOTIVE™
BLOUNT	BLOUNT™	HONDA	HONDA™	POWERGRD	POWER GUARD™
BLUEBIRD	BLUEBIRD BUS™	HOUGH	HOUGH™	PRIMEMOV	PRIME MOVER®
BOMBARD	BOMBARDIER™	HYSTER	HYSTER™	RACINE	RACINE™
BRIGGS&S	BRIGGS & STRATTON®	INGERSOL	INGERSOLL-RAND™	RAYGO	RAYGO™
BROCKWAY	BROCKWAY™	INGRAM	INGRAM™	RED DOT	REDDO™
BUCYRUSE	BUCYRUS-ERIE®	INSLEY	INSLEY™	REX	REX™
CABOT	CABOT™	INTERNL	INTERNATIONAL TRUCKS®	RIKER	RIKER®
CARRIER	CARRIER™	ISUZU	ISUZU™	ROYAL	ROYAL™
CASE	CASE™	J&J	J & J PARTS™	SCHOOLBS	SCHOOL BUS PARTS™
CAT	CATERPILLAR®	JACKSONV	JACKSON VIBRATORS™	SHUTTLEW	SHUTTLEWORTH®
CEDARRAP	CEDARAPIDS™	JAEGER	JAEGER™	SICARD	SICARD™
CHAMPION	CHAMPION™	JLGI	JLG®	SIMONDPX	SIMON-DUPLEX™
CHICAGOP	CHICAGO-PNEUMATIC™	JDEERE	JOHN DEERE™	SMITHCO	SMITH™
CLARK	CLARK™	JOHN MAT	JOHNSON MATTHEY™	SNORKEL	SNORKEL™
CMICORP	CMI CORP.™	JOHNSTON	JOHNSTON™	STEMCO	STEMCO®
COCKSHUT	COCKSHUTT™	JOY	JOY™	SULLAIR	SULLAIR®
CONDIESE	CONSOLIDATED DIESEL™	KAWASAKI	KAWASAKI™	SULLIVAN	SULLIVAN
CONTINDV	CONTINENTAL™	KENWORTH	KENWORTH™	SUPRP	SUPERIOR DIESEL™
CRANECAR	CRANE CARRIER®	KERSHAW	KERSHAW™	TAYLORMA	TAYLOR MACHINE™
CUBCADET	CUB CADET®	KOBELCO	KOBELCO™	TEREX	TEREX®
CUMMINS	CUMMINS®	KOEHRING	KOEHRING™	THERMOKI	THERMO KING™
DAEWOO	DAEWOO™	KOHLER	KOHLER®	THOMASBB	THOMAS BUILT BUSES™
DAVEY	DAVEY™	KOMATSU	KOMATSU™	TIMBERJA	TIMBERJACK™
DETROITD	DETROIT DIESEL®	KUBOTA	KUBOTA®	TORO	TORO®
DEUTZ	DEUTZ®	LEACH	LEACH™	TOWMOTOR	TOWMOTOR®
DIAMONDR	DIAMOND RIO™	LEROI	LEROI®	TRUCKEX	TRUCKEX™
DINA	DINA™	LINCOLNE	LINCOLN™	UNIVCOCH	UNIVERSAL COACH
DODGE	DODGE™	LINKBELT	LINK-BELT®	PARTS™	
DOMINION	DOMINION®	LOCKWOOD	LOCKWOOD™	VECTOR	VECTOR™
DON	DONALDSON®	LODAL	LODAL™	VERMEER	VERMEER®
DRILTECH	DRIL TECH™	LONG	LONG™	VERSATIL	VERSATILE®
DROTT	DROTT™	LORAIN	LORAIN®	VOGELE	VOGELE™
DYNAFLEX	DYNAFLEX®	MACK	MACK®	VOLKSWAG	VOLKSWAGON™
DYNAPAC	DYNAPAC™	MAN	MAN™	VOLVO	VOLVO™
EAGLEPIC	EAGLE™	MANITOWO	MANITOWOC™	WABCO	WABCO™
EATONYAL	EATON YALE & TOWNE™	MAREMONT	MAREMONT®	WALDON	WALDON EQUIPMENT™
EIMCO	EIMCO™	MASSEY	MASSEY-FERGUSON™	WALKERMF	WALKER®
ELGNSWPR	ELGIN SWEEPER™	MCI	MCI™	WARNERSW	WARNER & SWASEY™
EMERGENC	EMERGENCY ONE™	MELROE	MELROE™	WAUKESHA	WAUKESHA™
ENTWISTL	ENTWISTLE™	MERCEDES	MERCEDES™	WESTSTAR	WESTERN STAR®
ENUMCLAW	ENUMCLAW™	MILLEREL	MILLER™	WHITE	WHITE™
ERICKSON	ERICKSON™	MINNPAR	MINNPAR™	WHITING	WHITING™
FAIRMONT	FAIRMONT RAILWAY	MITSUBIS	MITSUBISHI™	WINCO	WINCO™
	MOTORS™	MORBARK	MORBARK®	WINNEBAG	WINNEBAGO™
FARMHAND	FARMHAND™	MOTORCO	MOTOR COACH™	WINPOWER	WINPOWER™
FATEROOT	FATE ROOT HEATH™	MWM	MWM™	WIS CON	WIS-CON™
FIATALLS	FIAT-ALLIS™	NACCO	NACCO™	WISCONS	WISCONSIN™
FIELDQUE	FIELD QUEEN™	NEOPART	NEOPART™	WORTHINT	WORTHINGTON™
FINN	FINN™	NEOPLAN	NEOPLAN USA™	YALETOWN	YALE™
FLXIBLE	FLXIBLE™	NEWFLYER	NEW FLYER™	YANMAR	YANMAR™
FMC	FMC™	NEWHOLLA	NEW HOLLAND™		

Cross Reference by Number

OEM No.	Manuf.	Our No.	OEM No.	Manuf.	Our No.	OEM No.	Manuf.	Our No.	OEM No.	Manuf.	Our No.
1487	DRILTECH	86180M	3692	AP	49130A	8167	AP	90863K	8976	AP	89165A
2220	SHUTTLEW	86136M	3693	AP	49135A	8300	TRUCKEX	929016A	8976	TRUCKEX	89165A
2225	SHUTTLEW	86136M	3694	AP	49140A	8462	AP	89519K	8978	AP	89167A
2240	SHUTTLEW	86518M	3695	AP	49150A	8483	AP	89519K	8978	TRUCKEX	89167A
2701	AP	86164M	3696	AP	49160A	8483	TRUCKEX	89519K	8979	AP	89252A
2704	AP	86139M	3697	AP	86183M	8679	AP	89125A	8979	TRUCKEX	89252A
2704	TRUCKEX	86139M	3697	TRUCKEX	86183M	8682	AP	89232A	8982	AP	89721K
2873	TORO	48111U	3698	AP	86503M	8684	AP	89132A	8982	TRUCKEX	89721K
2958	TRUCKEX	86164M	3699	AP	86130M	8685	AP	89133A	8983	AP	89722K
3150	TRUCKEX	86184M	3699	TRUCKEX	86682M	8733	LOCKWOOD	86178M	8983	TRUCKEX	89722K
3250	SHUTTLEW	86184M	3700	AP	86502M	8734	LOCKWOOD	86172M	8984	AP	89640K
3424	TRUCKEX	86675M	3700	TRUCKEX	86502M	8856	TRUCKEX	89759K	8984	TRUCKEX	89640K
3430	SHUTTLEW	86139M	3702	AP	86526M	8857	TRUCKEX	89772K	8985	AP	89641K
3430	SHUTTLEW	86521M	3703	AP	86511M	8868	AP	89708K	8985	TRUCKEX	89641K
3500	SHUTTLEW	86188M	3704	AP	86510M	8868	TRUCKEX	89708K	8986	AP	89642K
3590	SHUTTLEW	86113M	3705	AP	86597M	8870	AP	89709K	8986	TRUCKEX	89642K
3607	AP	86164M	3706	AP	86220M	8870	TRUCKEX	89709K	8987	AP	89643K
3608	AP	86164M	3707	AP	86530M	8872	AP	89710K	8987	TRUCKEX	89643K
3610	AP	86185M	3708	AP	86557M	8872	TRUCKEX	89710K	8988	AP	89644K
3610	TRUCKEX	86185M	3708	TRUCKEX	86557M	8875	AP	89712K	8988	TRUCKEX	89644K
3611	AP	86512M	3710	AP	86505M	8877	AP	89715K	8989	AP	89645K
3611	TRUCKEX	86512M	3710	TRUCKEX	86505M	8877	TRUCKEX	89715K	8990	AP	89646K
3614	AP	86125M	3711	AP	86500M	8878	AP	89723K	8990	TRUCKEX	89646K
3614	TRUCKEX	86125M	3711	TRUCKEX	86653M	8878	TRUCKEX	89723K	8991	AP	89166A
3616	AP	86159M	3712	AP	86514M	8879	AP	89724K	8991	TRUCKEX	89166A
3618	AP	86150M	3712	TRUCKEX	86740M	8879	TRUCKEX	89724K	9243	WHITING	86513M
3620	AP	86147M	3713	AP	86529M	8880	AP	89712K	9299	AP	89995C
3621	AP	86178M	3713	TRUCKEX	86529M	8880	TRUCKEX	89712K	9300	AP	89995C
3622	AP	86190M	3714	AP	86544M	8881	AP	89713K	9301	AP	89098A
3623	AP	86191M	3715	AP	86215M	8881	TRUCKEX	89713K	9303	AP	89099A
3625	AP	86127M	3716	AP	86536M	8882	AP	89714K	9304	AP	89102A
3625	TRUCKEX	86127M	3716	TRUCKEX	86536M	8882	TRUCKEX	89714K	9305	AP	89104A
3626	AP	86192M	3718	AP	86542M	8883	AP	89620K	9306	AP	89106A
3627	AP	86119M	3719	AP	86722M	8883	TRUCKEX	89620K	9308	AP	89108A
3629	AP	86119M	3719	TRUCKEX	86722M	8884	AP	89621K	9309	AP	89118A
3632	AP	86153M	3725	TRUCKEX	86522M	8884	TRUCKEX	89621K	9310	AP	89109A
3632	TRUCKEX	86153M	3851	TRUCKEX	86755M	8885	AP	89622K	9311	AP	89071A
3634	AP	86206M	3898	TRUCKEX	86115M	8885	TRUCKEX	89622K	9313	AP	89073A
3636	AP	86193M	4060	SHUTTLEW	86127M	8886	AP	89623K	9314	AP	89077A
3638	AP	86305M	4236	TRUCKEX	86543M	8886	TRUCKEX	89623K	9315	AP	89780A
3640	AP	86130M	4284	SHUTTLEW	86148M	8887	AP	89624K	9316	AP	90488A
3645	AP	86194M	4288	SHUTTLEW	86133M	8887	TRUCKEX	89624K	9317	AP	89075A
3646	AP	86180M	4450	DOMINION	86150M	8888	AP	89625K	9319	AP	89076A
3647	AP	86147M	4510	SHUTTLEW	86544M	8888	TRUCKEX	89625K	9329	AP	89092A
3647	TRUCKEX	86147M	4590	SHUTTLEW	86132M	8895	AP	89626K	9330	AP	89236A
3651	AP	86186M	4791	JACKSONV	86172M	8896	AP	89719K	9331	AP	89187A
3652	AP	86187M	4806	JACKSONV	86173M	8906	AP	89249A	9331	TRUCKEX	89187A
3653	AP	86189M	5102	BIGRIG	86108M	8906	TRUCKEX	89249A	9332	AP	89186A
3654	AP	86137M	5103	BIGRIG	86132M	8933	AP	89249A	9332	TRUCKEX	89186A
3654	TRUCKEX	86137M	5106	BIGRIG	86145M	8933	TRUCKEX	89249A	9333	AP	89184A
3655	AP	86139M	5108	BIGRIG	86113M	8942	AP	89279A	9333	TRUCKEX	89184A
3655	TRUCKEX	86139M	5109	BIGRIG	86144M	8942	TRUCKEX	89279A	9335	AP	89278A
3661	AP	86300M	5110	BIGRIG	86127M	8943	AP	89250A	9335	TRUCKEX	89278A
3663	AP	86135M	5112	BIGRIG	86130M	8943	TRUCKEX	89250A	9336	AP	89283A
3663	TRUCKEX	86135M	5203	BIGRIG	86137M	8953	AP	89271A	9336	TRUCKEX	89283A
3664	AP	86131M	5206	BIGRIG	86168M	8953	TRUCKEX	89271A	9337	AP	89091A
3666	AP	86108M	5302	BIGRIG	86125M	8955	AP	89274A	9338	AP	89093A
3666	TRUCKEX	86108M	5401	BIGRIG	86133M	8955	TRUCKEX	89274A	9339	AP	89095A
3667	AP	86102M	5510	SHUTTLEW	86130M	8956	AP	89275A	9340	AP	89097A
3667	AP	86132M	5540	CRANECAR	90368A	8956	TRUCKEX	89275A	9342	AP	90533A
3668	AP	86213M	5545	CRANECAR	90364A	8957	AP	89276A	9343	AP	90538A
3668	TRUCKEX	86213M	5546	CRANECAR	90365A	8957	TRUCKEX	89276A	9344	AP	90539A
3669	AP	86168M	5590	SHUTTLEW	86102M	8958	AP	89277A	9350	AP	89518K
3670	AP	86133M	5720	BIGRIG	49120B	8958	TRUCKEX	89277A	9353	TRUCKEX	90384A
3671	AP	86200M	5725	BIGRIG	49125A	8960	AP	89168A	9354	TRUCKEX	89640K
3673	AP	86200M	5730	BIGRIG	49130A	8960	TRUCKEX	89168A	9355	AP	89535K
3674	AP	86115M	5735	BIGRIG	49135A	8962	AP	89170A	9355	TRUCKEX	89535K
3675	AP	86203M	5740	BIGRIG	49140A	8962	TRUCKEX	89170A	9356	AP	89538K
3677	AP	86151M	5750	BIGRIG	49150A	8964	AP	89172A	9356	TRUCKEX	89538K
3678	AP	86149M	5760	BIGRIG	49160A	8964	TRUCKEX	89172A	9357	AP	89539K
3679	AP	86113M	6001	SHUTTLEW	86185M	8965	AP	89173A	9358	AP	89540K
3680	AP	86136M	6035	SHUTTLEW	86213M	8965	TRUCKEX	89173A	9358	TRUCKEX	89540K
3681	AP	86144M	6040	SHUTTLEW	86153M	8971	AP	89246A	9359	AP	89551K
3682	AP	86145M	6289	SHUTTLEW	86511M	8972	AP	89247A	9359	TRUCKEX	89551K
3683	AP	86173M	6290	SHUTTLEW	86510M	8972	TRUCKEX	89247A	9360	TRUCKEX	89537K
3684	AP	86175M	6291	SHUTTLEW	86512M	8973	AP	89248A	9362	TRUCKEX	90903K
3686	AP	86172M	6440	SHUTTLEW	86203M	8973	TRUCKEX	89248A	9363	AP	90076A
3687	AP	20153T	6973	DOMINION	86175M	8974	AP	89266A	9363	TRUCKEX	90076A
3689	AP	86106M	7440	SHUTTLEW	86149M	8974	TRUCKEX	89266A	9365	AP	90079A
3690	AP	49120B	7811	LEROI	86175M	8975	AP	89164A	9365	TRUCKEX	90079A
3691	AP	49125A	8052	TRUCKEX	90843K	8975	TRUCKEX	89164A	9366	AP	90080A

Cross Reference by Number

OEM No.	Manuf.	Our No.	OEM No.	Manuf.	Our No.	OEM No.	Manuf.	Our No.	OEM No.	Manuf.	Our No.
9366	TRUCKEX	90080A	9540	AP	89117A	10060	RIKER	86656M	10788	TRUCKEX	89926A
9369	AP	89460A	9541	AP	89123A	10061	RIKER	86526M	10789	TRUCKEX	89096A
9370	AP	89422A	9542	AP	89118A	10253	DOMINION	49140A	10790	TRUCKEX	89123A
9371	AP	89420A	9546	AP	89107C	10301	TRUCKEX	89098A	10791	TRUCKEX	900062A
9372	AP	89425A	9553	AP	90459A	10302	TRUCKEX	89230A	10792	TRUCKEX	89119A
9374	AP	89435A	9554	AP	89107A	10303	TRUCKEX	89099A	10793	TRUCKEX	89232A
9375	AP	89440A	9555	AP	90460A	10304	TRUCKEX	89102A	10794	TRUCKEX	89092A
9376	AP	89445A	9556	AP	89109A	10305	TRUCKEX	89104A	10921	TRUCKEX	89150A
9377	AP	89450A	9559	AP	89783A	10306	TRUCKEX	89106A	11001	DON	86164M
9378	AP	89427A	9560	AP	90465A	10308	TRUCKEX	89108A	11002	DON	86136M
9383	TRUCKEX	89523K	9561	AP	89081A	10309	TRUCKEX	89118A	11004	DON	86137M
9384	AP	89525W	9562	AP	89082A	10313	TRUCKEX	89073A	11014	DON	86300M
9384	TRUCKEX	89525W	9564	AP	89083A	10314	TRUCKEX	89077A	11015	DON	86139M
9385	AP	89526W	9565	AP	89087A	10315	TRUCKEX	89780A	11016	DON	86135M
9386	AP	89527W	9566	AP	89782A	10318	TRUCKEX	89243A	11019	DON	86119M
9386	TRUCKEX	89527W	9567	AP	89783A	10320	TRUCKEX	89241A	11020	DON	86131M
9387	AP	89528W	9568	AP	89086A	10330	TRUCKEX	89236A	11021	DON	86132M
9387	TRUCKEX	89528W	9573	AP	89440C	10337	TRUCKEX	89091A	11022	DON	86108M
9392	AP	89958K	9575	AP	89450C	10338	TRUCKEX	89093A	11023	DON	86102M
9393	AP	89966K	9580	TRUCKEX	89536K	10339	TRUCKEX	89095A	11024	DON	86145M
9394	AP	89961K	9599	TRUCKEX	89214A	10340	TRUCKEX	89097A	11025	DON	86113M
9395	AP	89505K	9600	TRUCKEX	89182A	10534	TRUCKEX	89113A	11026	DON	86106M
9395	TRUCKEX	89505K	9604	AP	90354A	10535	TRUCKEX	89235A	11031	DON	86168M
9396	AP	89506K	9604	TRUCKEX	90354A	10536	TRUCKEX	89114A	11032	DON	86133M
9396	TRUCKEX	89506K	9605	AP	90355A	10537	TRUCKEX	89115A	11033	DON	86200M
9398	TRUCKEX	89511K	9605	TRUCKEX	90355A	10538	TRUCKEX	89925A	11036	DON	86125M
9399	AP	89507K	9607	AP	90358A	10539	TRUCKEX	89116A	11037	DON	86147M
9399	TRUCKEX	89513K	9607	TRUCKEX	90358A	10540	TRUCKEX	89117A	11074	DON	86177M
9406	AP	89106C	9612	AP	89500K	10553	TRUCKEX	90459A	11076	DON	86178M
9415	AP	89780C	9612	TRUCKEX	89500K	10555	TRUCKEX	90460A	11077	DON	86172M
9417	AP	89075C	9613	AP	89512K	10556	TRUCKEX	89109A	11080	DON	86190M
9427	AP	89744C	9613	TRUCKEX	89512K	10557	TRUCKEX	89924A	11081	DON	86191M
9428	AP	89744C	9614	AP	89533K	10560	TRUCKEX	90465A	11084	DON	86173M
9430	AP	89775K	9614	TRUCKEX	89533K	10562	TRUCKEX	89082A	11085	DON	86150M
9451	AP	89761K	9615	AP	89503K	10564	TRUCKEX	89083A	11096	DON	86127M
9452	AP	89762K	9615	TRUCKEX	89503K	10565	TRUCKEX	89087A	11102	DON	86192M
9453	AP	89763K	9616	AP	89510K	10566	TRUCKEX	89782A	11107	DON	86119M
9457	AP	89771K	9617	AP	89509K	10620	TRUCKEX	89105A	11109	DON	86144M
9458	AP	89774C	9618	AP	89571K	10631	TRUCKEX	900072A	11112	DON	86175M
9470	AP	89955K	9618	TRUCKEX	89571K	10632	TRUCKEX	900073A	11119	DON	86108M
9471	AP	89956K	9619	AP	89532K	10633	TRUCKEX	900074A	11123	DON	86153M
9475	AP	89959K	9619	TRUCKEX	89532K	10635	TRUCKEX	900076A	11126	DON	86159M
9476	AP	89960K	9622	AP	89531K	10636	TRUCKEX	900077A	11127	DON	86213M
9477	AP	89971K	9622	TRUCKEX	89531K	10637	TRUCKEX	900078A	11129	DON	86206M
9478	AP	90569A	9624	AP	90547K	10639	TRUCKEX	900080A	11136	DON	86193M
9479	TRUCKEX	89508K	9627	TRUCKEX	89501K	10640	TRUCKEX	900081A	11142	DON	86148M
9486	AP	89548C	9628	TRUCKEX	900005A	10641	TRUCKEX	900082A	11145	DON	86118M
9486	TRUCKEX	89548C	9648	TRUCKEX	89881A	10643	TRUCKEX	900084A	11159	DON	86305M
9487	AP	89549C	9649	TRUCKEX	89256A	10644	TRUCKEX	900085A	11165	DON	86195M
9487	TRUCKEX	89549C	9650	TRUCKEX	89883A	10645	TRUCKEX	900086A	11167	DON	86130M
9490	AP	89566K	9653	TRUCKEX	89520K	10671	TRUCKEX	900046A	11169	DON	86130M
9490	TRUCKEX	89566K	9654	TRUCKEX	90531K	10674	TRUCKEX	900050A	11179	DON	86115M
9492	AP	89568K	9660	TRUCKEX	90350A	10675	TRUCKEX	89101A	11191	DON	86194M
9492	TRUCKEX	89568K	9662	TRUCKEX	90352A	10678	TRUCKEX	900056A	11197	DON	86180M
9493	AP	89569K	9663	TRUCKEX	90353A	10680	TRUCKEX	89784A	11204	DON	86203M
9493	TRUCKEX	89569K	9667	TRUCKEX	90363A	10681	TRUCKEX	89923A	11220	DON	86102M
9495	AP	89570K	9668	TRUCKEX	90364A	10683	TRUCKEX	89131A	11222	DON	86130M
9495	TRUCKEX	89570K	9669	TRUCKEX	90365A	10684	TRUCKEX	89132A	11224	DON	86130M
9498	AP	89996C	9670	TRUCKEX	90367A	10685	TRUCKEX	89133A	11876	DOMINION	86106M
9499	AP	89995C	9671	TRUCKEX	90369A	10727	TRUCKEX	89074A	12000	DON	49115U
9500	AP	89995C	9678	TRUCKEX	90375A	10732	TRUCKEX	89075A	12001	DON	49115U
9501	TRUCKEX	89556K	9686	TRUCKEX	90382A	10733	TRUCKEX	89076A	12002	DON	49120B
9501	AP	89956K	9692	TRUCKEX	90386A	10741	TRUCKEX	89242A	12003	DON	49125A
9502	AP	89557K	9693	TRUCKEX	90387A	10745	TRUCKEX	89084A	12004	DON	49130A
9502	TRUCKEX	89557K	9722	TRUCKEX	89185A	10746	TRUCKEX	89783A	12005	DON	49135A
9503	AP	89558K	9726	TRUCKEX	89786K	10747	TRUCKEX	89085A	12006	DON	49140A
9503	TRUCKEX	89558K	9727	TRUCKEX	89787K	10755	TRUCKEX	89239A	12007	DON	49150A
9504	AP	89559K	9728	TRUCKEX	89788K	10757	TRUCKEX	89101A	12008	DON	49160A
9504	TRUCKEX	89559K	9729	TRUCKEX	89789K	10758	TRUCKEX	900052A	12422	OHIOLCRN	89450E
9506	AP	89560K	9734	TRUCKEX	89550C	10759	TRUCKEX	89103A	12506	FINN	86106M
9506	TRUCKEX	89560K	9735	TRUCKEX	89510K	10762	TRUCKEX	89106A	12526	FINN	89154A
9518	AP	90470K	10006	RIKER	86221M	10763	TRUCKEX	90463A	14337	AP	89261A
9530	AP	90465C	10008	RIKER	86544M	10764	TRUCKEX	89924A	14337	TRUCKEX	89261A
9532	AP	89111A	10013	RIKER	86118M	10765	TRUCKEX	89107A	14338	AP	89263A
9533	AP	89233A	10015	RIKER	86118M	10773	TRUCKEX	89110A	14338	TRUCKEX	89263A
9534	AP	89113A	10018	RIKER	86118M	10774	TRUCKEX	89111A	14339	AP	89160A
9535	AP	89114A	10020	RIKER	86130M	10775	TRUCKEX	89233A	14340	AP	89161A
9536	AP	89114A	10027	RIKER	86535M	10776	TRUCKEX	89090A	14341	AP	89162A
9537	AP	89115A	10028	RIKER	86533M	10778	TRUCKEX	89234A	14343	AP	89151A
9538	AP	89925A	10029	RIKER	86531M	10781	TRUCKEX	89094A	14343	TRUCKEX	89151A
9539	AP	89116A	10045	RIKER	86547M	10785	TRUCKEX	89126A	14601	AP	89160A

Cross Reference by Number

OEM No.	Manuf.	Our No.	OEM No.	Manuf.	Our No.	OEM No.	Manuf.	Our No.	OEM No.	Manuf.	Our No.
14601	TRUCKEX	89160A	21188	WALKERMF	86177M	22715	WALKERMF	86690M	24715	AP	89145C
14602	AP	89161A	21260	WALKERMF	86135M	22765	WALKERMF	86172M	24716	AP	89146C
14602	TRUCKEX	89161A	21287	WALKERMF	86136M	22767	WALKERMF	86192M	24717	AP	89155A
14603	AP	89162A	21325	WALKERMF	86136M	22768	WALKERMF	86193M	24717	TRUCKEX	89155A
14603	TRUCKEX	89162A	21328	WALKERMF	86137M	22774	WALKERMF	49160A	24718	AP	89156A
14605	AP	89163A	21331	WALKERMF	86136M	22789	WALKERMF	86653M	24718	TRUCKEX	89156A
14605	TRUCKEX	89163A	21365	WALKERMF	86137M	22809	WALKERMF	86131M	24721	AP	89155C
14618	AP	89143A	21372	WALKERMF	86136M	22822	WALKERMF	86135M	24722	AP	89156C
14618	TRUCKEX	89143A	21464	WALKERMF	86144M	22823	WALKERMF	86132M	24731	AP	89211A
14619	AP	89144A	21465	WALKERMF	86133M	22828	WALKERMF	86108M	24735	AP	89022A
14619	TRUCKEX	89144A	21467	WALKERMF	86150M	22829	WALKERMF	86102M	24735	TRUCKEX	89022A
14620	AP	90909A	21468	WALKERMF	86187M	22835	WALKERMF	86200M	24737	AP	89025A
14620	TRUCKEX	90909A	21470	WALKERMF	86188M	22843	WALKERMF	86203M	24737	TRUCKEX	89025A
14621	AP	89143C	21471	WALKERMF	86189M	22844	WALKERMF	86113M	24739	AP	89028A
14622	AP	89144C	21473	WALKERMF	86178M	22851	WALKERMF	86130M	24739	TRUCKEX	89028A
14623	AP	90909C	21475	WALKERMF	86137M	22852	WALKERMF	86164M	24745	AP	89052A
14654	TRUCKEX	89152A	21476	WALKERMF	86139M	22861	WALKERMF	11026T	24745	TRUCKEX	89052A
14737	TRUCKEX	89730K	21495	WALKERMF	86136M	22865	WALKERMF	86184M	24746	AP	89055A
14738	TRUCKEX	90903K	21540	WALKERMF	86137M	22866	WALKERMF	86183M	24746	TRUCKEX	89055A
14740	TRUCKEX	90902K	21578	WALKERMF	49120B	22867	WALKERMF	11731T	24747	AP	89058A
15001	RIKER	86115M	21579	WALKERMF	49125A	22879	WALKERMF	17704T	24747	TRUCKEX	89058A
15003	RIKER	86125M	21580	WALKERMF	49130A	22888	WALKERMF	86502M	24748	AP	89043A
15005	RIKER	86147M	21581	WALKERMF	49135A	22896	WALKERMF	86514M	24749	AP	89043C
15007	RIKER	86147M	21582	WALKERMF	49140A	22897	WALKERMF	86557M	24750	AP	89046A
15008	RIKER	86220M	21584	WALKERMF	49150A	22899	WALKERMF	86529M	24750	TRUCKEX	89046A
15010	RIKER	86194M	21723	WALKERMF	86186M	22899	WALKERMF	86644M	24751	AP	89046C
15013	RIKER	86180M	21745	WALKERMF	86137M	22904	WALKERMF	18202T	24752	AP	89600K
16001	CUMMINS	89435E	21752	WALKERMF	86300M	22905	WALKERMF	14663T	24752	TRUCKEX	89600K
17279	BUCYRUSE	86177M	21832	WALKERMF	86512M	22907	WALKERMF	86180M	24753	AP	89603K
17765	PETTIBON	86173M	21833	WALKERMF	86118M	22908	WALKERMF	89996C	24753	TRUCKEX	89603K
19716	ENUMCLAW	49135A	21835	WALKERMF	86145M	22914	WALKERMF	86624M	24754	AP	89606K
21003	WALKERMF	86136M	21837	WALKERMF	86133M	22915	WALKERMF	86526M	24754	TRUCKEX	89731K
21004	WALKERMF	86137M	21838	WALKERMF	86127M	22916	WALKERMF	86544M	24755	AP	89609K
21007	WALKERMF	86136M	21923	WALKERMF	86115M	22917	WALKERMF	86194M	24755	TRUCKEX	89609K
21013	CRANECAR	86108M	21925	WALKERMF	86164M	22920	WALKERMF	86682M	24757	AP	89055C
21016	CRANECAR	86150M	21968	WALKERMF	86151M	22924	WALKERMF	86531M	24758	AP	89058C
21018	CRANECAR	86125M	21969	WALKERMF	86148M	22925	WALKERMF	86196M	24835	AP	89607K
21018	WALKERMF	86139M	21970	WALKERMF	86152M	22932	WALKERMF	86695M	24835	TRUCKEX	89607K
21021	WALKERMF	86132M	21971	WALKERMF	86149M	22936	WALKERMF	86713M	24836	AP	89728K
21022	WALKERMF	86136M	22004	WALKERMF	86153M	22937	WALKERMF	86547M	24836	TRUCKEX	89728K
21023	CRANECAR	86139M	22005	WALKERMF	49160A	22938	WALKERMF	86626M	24849	AP	89604K
21026	CRANECAR	86133M	22006	WALKERMF	86597M	22940	WALKERMF	86739M	24849	TRUCKEX	89604K
21028	WALKERMF	86136M	22020	WALKERMF	14490T	22941	WALKERMF	86740M	24850	AP	89618K
21030	CRANECAR	86133M	22022	WALKERMF	14472T	22943	WALKERMF	86753M	24850	TRUCKEX	89618K
21030	WALKERMF	86137M	22025	WALKERMF	11650T	22944	WALKERMF	86606M	24936	TRUCKEX	89797K
21035	CRANECAR	86108M	22033	WALKERMF	10156T	22962	WALKERMF	86773M	24939	TRUCKEX	89040A
21037	CRANECAR	86102M	22034	WALKERMF	11731T	23506	FINN	86192M	24941	TRUCKEX	89212A
21040	WALKERMF	16487T	22041	WALKERMF	18901T	23991	KOEHRRING	86172M	28495	TRUCKEX	89211A
21046	CRANECAR	86125M	22095	WALKERMF	14663T	24344	AP	89153A	29040	WALKERMF	89748A
21047	CRANECAR	86147M	22100	WALKERMF	86675M	24344	TRUCKEX	89153A	29041	WALKERMF	89744C
21057	WALKERMF	22152T	22214	WALKERMF	86510M	24345	AP	89154A	29043	WALKERMF	89748A
21057	CRANECAR	86108M	22226	WALKERMF	86173M	24345	TRUCKEX	89154A	29043	WALKERMF	89748A
21060	WALKERMF	14245T	22231	WALKERMF	86185M	24346	AP	90913A	29044	WALKERMF	89996C
21061	WALKERMF	13900T	22235	WALKERMF	86186M	24346	TRUCKEX	90913A	29045	WALKERMF	89744C
21064	CRANECAR	86135M	22337	WALKERMF	86503M	24347	AP	89156A	29046	WALKERMF	89749C
21066	CRANECAR	86213M	22356	WALKERMF	86186M	24654	AP	89740K	29047	WALKERMF	90856C
21067	CRANECAR	86200M	22390	WALKERMF	11669T	24654	TRUCKEX	89796K	29048	WALKERMF	89749C
21069	WALKERMF	86756M	22391	WALKERMF	86511M	24655	AP	89742K	29052	WALKERMF	89748A
21070	CRANECAR	86102M	22449	WALKERMF	86505M	24672	AP	89146A	29101	WALKERMF	89155C
21070	WALKERMF	86570M	22449	WALKERMF	86664M	24673	AP	89146C	29102	WALKERMF	89156C
21071	WALKERMF	86607M	22533	WALKERMF	15572T	24674	TRUCKEX	89794K	29108	WALKERMF	89924C
21072	CRANECAR	86203M	22534	WALKERMF	21326A	24675	AP	89613K	29109	WALKERMF	90847C
21072	WALKERMF	86755M	22536	WALKERMF	22150T	24675	TRUCKEX	89613K	29110	WALKERMF	89775K
21073	WALKERMF	86754M	22538	WALKERMF	86556M	24676	AP	89617K	29111	WALKERMF	89145C
21074	WALKERMF	86548M	22551	WALKERMF	86536M	24676	TRUCKEX	89617K	29112	WALKERMF	89146C
21078	CRANECAR	86130M	22552	WALKERMF	86147M	24677	AP	89727K	29113	WALKERMF	89780C
21081	CRANECAR	86300M	22555	WALKERMF	86220M	24677	TRUCKEX	89727K	29200	WALKERMF	89781C
21083	CRANECAR	86203M	22566	WALKERMF	86722M	24678	AP	89731K	29201	WALKERMF	89043C
21083	WALKERMF	86751M	22570	WALKERMF	86562M	24696	AP	89147A	29202	WALKERMF	89046C
21084	WALKERMF	86757M	22571	WALKERMF	86561M	24696	TRUCKEX	89147A	29205	WALKERMF	89052C
21088	WALKERMF	86744M	22572	WALKERMF	86560M	24697	TRUCKEX	89157A	29206	WALKERMF	89055C
21090	CRANECAR	86195M	22604	WALKERMF	86537M	24701	AP	89218C	29207	WALKERMF	89058C
21093	CRANECAR	86195M	22630	WALKERMF	86173M	24710	AP	89214A	29208	WALKERMF	90451C
21094	CRANECAR	86194M	22632	WALKERMF	86106M	24711	AP	89216A	29209	WALKERMF	90465C
21124	WALKERMF	86136M	22642	WALKERMF	86725M	24711	TRUCKEX	89216A	29210	WALKERMF	89107C
21125	WALKERMF	86137M	22643	WALKERMF	86724M	24712	AP	89218A	29211	WALKERMF	89106C
21126	WALKERMF	86136M	22662	WALKERMF	86685M	24712	TRUCKEX	89218A	29212	WALKERMF	89784C
21127	WALKERMF	86136M	22664	WALKERMF	86530M	24713	AP	89145A	29214	WALKERMF	90452C
21155	WALKERMF	86137M	22667	WALKERMF	86723M	24713	TRUCKEX	89145A	29242	WALKERMF	89748A
21169	WALKERMF	86136M	22668	WALKERMF	86698M	24714	AP	89146A	29248	WALKERMF	89748A
21174	WALKERMF	86125M	22669	WALKERMF	86697M	24714	TRUCKEX	89146A	29301	WALKERMF	89993C

Cross Reference by Number

OEM No.	Manuf.	Our No.	OEM No.	Manuf.	Our No.	OEM No.	Manuf.	Our No.	OEM No.	Manuf.	Our No.
29303	WALKERMF	89109C	34723	AP	89044A	35734	WALKERMF	90080A	40590	WALKERMF	900121A
29304	WALKERMF	89053C	34723	TRUCKEX	89044A	35746	WALKERMF	89510K	41001	WALKERMF	89098A
29305	WALKERMF	89056C	34724	AP	89047A	35747	WALKERMF	89971K	41001	WALKERMF	900046A
29310	WALKERMF	89017C	34725	AP	89036C	35753	WALKERMF	90867A	41002	WALKERMF	89099A
29402	WALKERMF	89045C	34743	TRUCKEX	89607K	35757	WALKERMF	90868A	41002	WALKERMF	900048A
29405	WALKERMF	89994C	34743	AP	89608K	35760	WALKERMF	89546K	41003	WALKERMF	89101A
29408	WALKERMF	89057C	34744	TRUCKEX	89311K	35772	WALKERMF	90866A	41004	WALKERMF	89103A
29409	WALKERMF	89060C	34744	AP	89611K	35773	WALKERMF	89547K	41005	WALKERMF	89105A
29410	WALKERMF	89021C	34746	AP	89056C	35774	WALKERMF	90867A	41094	WALKERMF	89151A
29411	WALKERMF	90452C	34785	AP	89605K	35776	WALKERMF	89568K	41095	WALKERMF	89153A
29501	WALKERMF	89019C	34785	TRUCKEX	89605K	35777	WALKERMF	89569K	41096	WALKERMF	89154A
29502	WALKERMF	89222C	34786	AP	89619K	35784	WALKERMF	89955K	41097	WALKERMF	89155A
29505	WALKERMF	925051C	34786	TRUCKEX	89619K	35785	WALKERMF	89960K	41097	WALKERMF	90913A
29506	WALKERMF	89217C	34799	AP	924037A	35786	WALKERMF	89545K	41099	WALKERMF	89232A
29507	WALKERMF	89031C	34799	TRUCKEX	924037A	35787	WALKERMF	89547K	41099	WALKERMF	900050A
29508	WALKERMF	89226C	34827	TRUCKEX	89053A	35788	WALKERMF	89548K	41154	WALKERMF	89098A
29509	WALKERMF	89227C	34828	TRUCKEX	89037A	35789	WALKERMF	89549K	41187	WALKERMF	89071A
29510	WALKERMF	89298C	34879	TRUCKEX	923042A	35790	WALKERMF	89762K	41204	WALKERMF	89132A
29511	WALKERMF	90438C	35036	WALKERMF	89520K	35791	WALKERMF	89763K	41217	WALKERMF	89133A
29512	WALKERMF	90444C	35103	WALKERMF	89519K	35795	WALKERMF	89550K	41221	WALKERMF	89091A
29600	WALKERMF	89985C	35194	WALKERMF	89440A	35796	WALKERMF	89518K	41222	WALKERMF	89093A
29602	WALKERMF	89920C	35195	WALKERMF	89450A	35799	WALKERMF	89558K	41223	WALKERMF	89095A
29603	WALKERMF	89988C	35216	WALKERMF	89766K	35800	WALKERMF	89559K	41224	WALKERMF	89097A
29604	WALKERMF	89296C	35227	WALKERMF	90875A	35804	WALKERMF	89506K	41250	WALKERMF	89141A
29605	WALKERMF	89293C	35228	WALKERMF	90877A	35805	WALKERMF	89513K	41251	WALKERMF	89105A
29701	WALKERMF	89989C	35290	WALKERMF	89520K	35806	WALKERMF	89503K	41252	WALKERMF	89103A
29702	WALKERMF	89986C	35291	WALKERMF	89526W	35807	WALKERMF	49115U	41256	WALKERMF	89094A
29800	WALKERMF	89987C	35292	WALKERMF	89527W	35853	WALKERMF	90079A	41365	WALKERMF	89101A
29801	WALKERMF	89990C	35293	WALKERMF	89528W	35855	WALKERMF	89535K	41366	WALKERMF	89103A
29802	WALKERMF	90442C	35304	WALKERMF	89543K	35856	WALKERMF	89538K	41367	WALKERMF	89105A
29804	WALKERMF	90449C	35332	WALKERMF	90531K	35885	WALKERMF	89771K	41378	WALKERMF	89105A
29805	WALKERMF	90576C	35343	WALKERMF	90928K	35886	WALKERMF	89761K	41428	WALKERMF	89083A
29806	WALKERMF	89295C	35344	WALKERMF	90914K	35887	WALKERMF	89762K	41429	WALKERMF	89087A
29807	WALKERMF	89298C	35348	WALKERMF	90857K	35898	WALKERMF	90843K	41429	WALKERMF	900068A
29900	WALKERMF	900089C	35354	WALKERMF	90916K	35899	WALKERMF	900005A	41430	WALKERMF	89782A
29901	WALKERMF	90526C	35370	WALKERMF	89767K	35907	WALKERMF	89440A	41431	WALKERMF	89783A
29902	WALKERMF	90450C	35372	WALKERMF	90857K	35909	WALKERMF	89445A	41432	WALKERMF	89111A
29903	WALKERMF	90579C	35393	WALKERMF	89460A	35910	WALKERMF	89450A	41433	WALKERMF	89233A
29905	WALKERMF	90577C	35401	WALKERMF	89500K	35931	WALKERMF	89440C	41434	WALKERMF	89113A
29906	WALKERMF	90578C	35406	WALKERMF	90928K	35932	WALKERMF	89450C	41435	WALKERMF	89114A
30855	ENUMCLAW	49140A	35407	WALKERMF	90914K	35933	WALKERMF	89763K	41435	WALKERMF	900058A
31246	WALKERMF	90822A	35408	WALKERMF	90929K	35934	WALKERMF	89525W	41436	WALKERMF	89117A
33221	WALKERMF	90363A	35413	WALKERMF	90915K	35935	WALKERMF	89763K	41436	WALKERMF	900062A
33222	WALKERMF	90364A	35414	WALKERMF	90916K	35936	WALKERMF	89526W	41438	WALKERMF	89082A
33223	WALKERMF	90365A	35422	WALKERMF	89525W	35937	WALKERMF	89527W	41439	WALKERMF	89243A
33225	WALKERMF	90368A	35423	WALKERMF	90464K	35938	WALKERMF	89528W,	41440	WALKERMF	89242A
33359	WALKERMF	89525B	35424	WALKERMF	90092A		WALKERMF	900273A	41441	WALKERMF	89099A
33960	WALKERMF	89526K	35442	WALKERMF	89771K		WALKERMF	(Upgrade)	41442	WALKERMF	89232A
33961	WALKERMF	89527B	35444	WALKERMF	89566K	35961	WALKERMF	89527B	41472	WALKERMF	89105A
33962	WALKERMF	89528B	35445	WALKERMF	89546K	35972	WALKERMF	89539K	41473	WALKERMF	89116A
33964	WALKERMF	89524K	35449	WALKERMF	89511K	35975	WALKERMF	89528K	41480	WALKERMF	90538A
33966	WALKERMF	90353A	35456	WALKERMF	89548C	35976	WALKERMF	89527K	41515	WALKERMF	89883A
33967	WALKERMF	90354A	35457	WALKERMF	89549C	35977	WALKERMF	89526K	41532	WALKERMF	89784A
33968	WALKERMF	90355A	35495	WALKERMF	89508K	35978	WALKERMF	89525K	41534	WALKERMF	89102A
33969	WALKERMF	90369A	35496	WALKERMF	89501K	35979	WALKERMF	89523K	41534	WALKERMF	900052A
33970	WALKERMF	90358A	35497	WALKERMF	89550C	35980	WALKERMF	89529K	41535	WALKERMF	89101A
33971	WALKERMF	90350A	35498	WALKERMF	89533K	35983	WALKERMF	89540K	41536	WALKERMF	89090A
33973	WALKERMF	90352A	35499	WALKERMF	89509K	35984	WALKERMF	89551K	41537	WALKERMF	89092A
34110	ERICKSON	49120B	35500	WALKERMF	89514K	39132	NEWFLYER	89503K	41538	WALKERMF	89126A
34112	ERICKSON	86177M	35512	WALKERMF	89420A	40005	WALKERMF	89708K	41539	WALKERMF	90533A
34673	AP	89729K	35513	WALKERMF	89422A	40006	WALKERMF	89709K	41540	WALKERMF	90539A
34673	TRUCKEX	89729K	35514	WALKERMF	89425A	40007	WALKERMF	89710K	41557	WALKERMF	89266A
34674	AP	89733K	35520	WALKERMF	89531K	40008	WALKERMF	89712K	41558	WALKERMF	89098A
34674	TRUCKEX	89733K	35606	WALKERMF	90076A	40009	SULLAIR	86177M	41560	WALKERMF	89119A
34703	AP	89026C	35617	WALKERMF	89427A	40009	WALKERMF	89712K	41583	WALKERMF	89236A
34708	AP	89017C	35619	WALKERMF	89435A	40010	WALKERMF	89713K	41603	WALKERMF	90938A
34711	AP	89014A	35620	WALKERMF	89521K	40011	WALKERMF	89714K	41612	WALKERMF	900069A
34712	AP	89017A	35621	WALKERMF	89522K	40012	WALKERMF	89715K	41614	WALKERMF	900076A
34713	AP	89020A	35622	WALKERMF	89524K	40020	WALKERMF	89721K	41615	WALKERMF	900077A
34713	TRUCKEX	89020A	35624	WALKERMF	89556K	40021	WALKERMF	89722K	41616	WALKERMF	900078A
34714	AP	89023A	35640	WALKERMF	89532K	40022	WALKERMF	89723K	41618	WALKERMF	900072A
34714	TRUCKEX	89023A	35641	WALKERMF	89507K	40023	WALKERMF	89724K	41619	WALKERMF	900073A
34715	AP	89026A	35658	WALKERMF	89502K	40024	WALKERMF	89713K	41620	WALKERMF	900074A
34715	TRUCKEX	89026A	35664	WALKERMF	89962K	40025	WALKERMF	89714K	41622	WALKERMF	900084A
34716	AP	89029A	35683	WALKERMF	89958K	40026	WALKERMF	89715K	41623	WALKERMF	900085A
34716	TRUCKEX	89029A	35690	WALKERMF	89500K	40247	WALKERMF	89940A	41624	WALKERMF	900086A
34717	AP	89050A	35692	WALKERMF	89570K	40256	WALKERMF	89941A	41626	WALKERMF	900080A
34719	AP	89056A	35693	WALKERMF	89560K	40257	WALKERMF	89951A	41627	WALKERMF	900081A
34719	TRUCKEX	89056A	35695	WALKERMF	89505K	40282	SULLAIR	86150M	41628	WALKERMF	900082A
34720	AP	89059A	35696	WALKERMF	89557K	40364	WALKERMF	89950A	41629	WALKERMF	89116A
34720	TRUCKEX	89059A	35733	WALKERMF	89537K	40577	WALKERMF	90993A	41629	WALKERMF	900062A

Cross Reference by Number

OEM No.	Manuf.	Our No.	OEM No.	Manuf.	Our No.	OEM No.	Manuf.	Our No.	OEM No.	Manuf.	Our No.
41630	WALKERMF	89923A	41998	WALKERMF	89278A	43168	WALKERMF	90459A	44854	TRUCKEX	89021A
41631	WALKERMF	89110A	42065	WALKERMF	89600K	43196	WALKERMF	924037A	44921	WACTOR	89430E
41632	NEWFLYER	89550K	42066	WALKERMF	89603K	43202	WALKERMF	89729K	45066	WALKERMF	89217A
41632	WALKERMF	89782A	42067	WALKERMF	89606K	43203	WALKERMF	89733K	45076	WALKERMF	925005A
41633	WALKERMF	89103A	42068	WALKERMF	89609K	43233	WALKERMF	89892A	45233	WALKERMF	89226A
41634	NEWFLYER	89460C	42069	WALKERMF	89607K	43277	WALKERMF	923008A	45247	WALKERMF	90444A
41634	NEWFLYER	89923A	42071	WALKERMF	89055A	43305	SULLAIR	86213M	45320	WALKERMF	89893A
41634	WALKERMF	89923A	42072	WALKERMF	89058A	43319	WALKERMF	89026A	45327	WALKERMF	926062A
41635	WALKERMF	89105A	42125	WALKERMF	89123A	43320	WALKERMF	89056A	45339	WALKERMF	89205A
41636	WALKERMF	89090A	42125	WALKERMF	900061A	43321	WALKERMF	89059A	45340	WALKERMF	89019A
41637	WALKERMF	89092A	42126	WALKERMF	89218A	43324	WALKERMF	923042A	45344	SULLAIR	89425A
41638	WALKERMF	89116A	42127	WALKERMF	89214A	43348	WALKERMF	89107A	45455	WALKERMF	89617K
41638	WALKERMF	900059A	42128	WALKERMF	89147A	43362	WALKERMF	90922A	45564	SULLAIR	86173M
41639	WALKERMF	89780A	42129	WALKERMF	89155A	43366	WALKERMF	89023A	45726	WALKERMF	92922A
41646	WALKERMF	89955K	42130	WALKERMF	89156A	43381	WALKERMF	89608K	45727	WALKERMF	89049A
41647	WALKERMF	89958K	42147	WALKERMF	89123A	43382	WALKERMF	89311K	45779	WALKERMF	89880A
41649	WALKERMF	89963K	42175	WALKERMF	89794K	43438	WALKERMF	90460A	45946	WALKERMF	925014A
41650	WALKERMF	89960K	42177	WALKERMF	89796K	43467	WALKERMF	90823A	46588	WALKERMF	926005A
41652	WALKERMF	89964K	42178	WALKERMF	89212A	43582	WALKERMF	89029A	46670	WALKERMF	926008A
41653	WALKERMF	89965K	42185	WALKERMF	89104A	43587	WALKERMF	90451A	46736	WALKERMF	926011A
41654	WALKERMF	89966K	42186	WALKERMF	90983A	43588	WALKERMF	90452A	46778	WALKERMF	89031A
41655	WALKERMF	89967K	42246	WALKERMF	89074A	43601	WALKERMF	89104A	46821	WALKERMF	926072A
41656	WALKERMF	89956K	42247	WALKERMF	89084A	43602	WALKERMF	89106A	47645	WALKERMF	927010A
41658	WALKERMF	89961K	42249	WALKERMF	89085A	43606	WALKERMF	89020A	47960	WALKERMF	929002A
41659	WALKERMF	90567A	42252	WALKERMF	89239A	43668	WALKERMF	89076A	47961	WALKERMF	929003A
41663	WALKERMF	89958K	42253	WALKERMF	89926A	43698	WALKERMF	89115A	47962	WALKERMF	929004A
41685	WALKERMF	89090A	42262	MWM	89430E	43699	WALKERMF	89118A	47972	WALKERMF	929002A
41686	WALKERMF	89780A	42272	WALKERMF	89107A	43718	WALKERMF	89044A	47973	WALKERMF	929003A
41688	WALKERMF	89971K	42274	WALKERMF	89117A	43719	WALKERMF	89047A	47974	WALKERMF	929004A
41692	WALKERMF	90903K	42288	WALKERMF	89114A	44095	WALKERMF	924004A	47976	WALKERMF	929002A
41693	WALKERMF	89730K	42317	WALKERMF	89797K	44112	WALKERMF	89125A	47977	WALKERMF	929003A
41694	WALKERMF	90902K	42336	WALKERMF	89780A	44126	WALKERMF	89027A	47978	WALKERMF	929004A
41696	WALKERMF	89967K	42336	WALKERMF	900064A	44127	WALKERMF	89030A	47984	WALKERMF	89670K
41751	SULLAIR	86172M	42338	WALKERMF	89728K	44132	WALKERMF	924005A	47986	WALKERMF	89697K
41763	WALKERMF	89230A	42344	WALKERMF	89234A	44154	WALKERMF	924008A	47987	WALKERMF	929014K
41889	WALKERMF	89252A	42377	WALKERMF	89146A	44200	WALKERMF	924005A	47988	WALKERMF	929013K
41890	WALKERMF	89881A	42423	WALKERMF	89727K	44203	WALKERMF	89887A	47989	WALKERMF	929013K
41891	WALKERMF	89256A	42424	WALKERMF	89731K	44299	WALKERMF	89057A	47993	WALKERMF	89670K
41892	WALKERMF	89160A	42445	WALKERMF	89102A	44300	WALKERMF	89060A	47995	WALKERMF	89697K
41893	WALKERMF	89161A	42447	WALKERMF	90909A	44301	WALKERMF	89021A	47996	WALKERMF	929014K
41894	WALKERMF	89276A	42448	WALKERMF	89143A	44302	WALKERMF	89037A	48348	AP	923008A
41895	WALKERMF	89162A	42449	WALKERMF	89144A	44308	SULLAIR	89422A	48348	TRUCKEX	923008A
41896	WALKERMF	89166A	42451	WALKERMF	89073A	44456	WALKERMF	89015A	48349	AP	924004A
41897	WALKERMF	89167A	42452	WALKERMF	89077A	44457	WALKERMF	89018A	48349	TRUCKEX	924004A
41898	WALKERMF	89277A	42453	WALKERMF	89075A	44557	WALKERMF	924037A	49003	WALKERMF	90615K
41899	WALKERMF	89163A	42455	WALKERMF	89617K	44569	WALKERMF	89109A	49006	WALKERMF	89670K
41902	WALKERMF	89249A	42478	WALKERMF	89141A	44634	WALKERMF	89042A	49007	WALKERMF	89697K
41909	WALKERMF	89173A	42492	WALKERMF	89613K	44637	WALKERMF	89045A	49008	WALKERMF	929014K
41940	WALKERMF	89261A	42500	WALKERMF	89924A	44638	WALKERMF	89048A	49009	WALKERMF	90615K
41944	WALKERMF	89249A	42530	WALKERMF	89028A	44656	AP	89027A	49010	WALKERMF	929015K
41947	WALKERMF	89249A	42531	WALKERMF	89025A	44656	TRUCKEX	89027A	49011	WALKERMF	929022K
41957	WALKERMF	89263A	42543	WALKERMF	89046A	44657	AP	89015A	49012	WALKERMF	929023K
41963	WALKERMF	89279A	42544	WALKERMF	89043A	44657	TRUCKEX	89015A	49015	WALKERMF	89675K
41965	WALKERMF	89250A	42562	WALKERMF	900063A	44658	AP	89030A	49016	WALKERMF	929013K
41969	WALKERMF	89160A	42606	WALKERMF	89211A	44658	TRUCKEX	89030A	49024	WALKERMF	89670K
41970	WALKERMF	89164A	42715	WALKERMF	89145A	44659	AP	89018A	49025	WALKERMF	89697K
41972	WALKERMF	89182A	42716	WALKERMF	89146A	44659	TRUCKEX	89018A	49026	WALKERMF	929014K
41973	WALKERMF	89271A	42728	CMICORP	86153M	44660	AP	89027C	49027	WALKERMF	89676K
41974	WALKERMF	89168A	42758	WALKERMF	89780A	44662	AP	89030C	49028	WALKERMF	89642K
41976	WALKERMF	89164A	42758	WALKERMF	900064A	44664	AP	89057A	49029	WALKERMF	89643K
41977	WALKERMF	89161A	42760	WALKERMF	89073A	44664	TRUCKEX	89057A	49030	WALKERMF	89644K
41978	WALKERMF	89165A	42761	WALKERMF	89077A	44665	AP	89045A	49031	WALKERMF	89645K
41979	WALKERMF	89246A	42763	WALKERMF	89924A	44665	TRUCKEX	89045A	49032	WALKERMF	89622K
41980	WALKERMF	89184A	42855	WALKERMF	89075A	44666	AP	89060A	49033	WALKERMF	89623K
41981	WALKERMF	89274A	42855	WALKERMF	900065A	44666	TRUCKEX	89060A	49034	WALKERMF	89624K
41982	WALKERMF	89170A	42856	WALKERMF	90465A	44667	AP	89048A	49035	WALKERMF	89625K
41983	WALKERMF	89165A	42857	WALKERMF	89115A	44667	TRUCKEX	89048A	49036	WALKERMF	89646K
41984	WALKERMF	89172A	42858	WALKERMF	89107A	44668	AP	89057C	49037	WALKERMF	89647K
41985	WALKERMF	89162A	42891	WALKERMF	89216A	44669	AP	89045C	49040	WALKERMF	90615K
41986	WALKERMF	89166A	42936	WALKERMF	89925A	44670	AP	89060C	49041	WALKERMF	929015K
41987	WALKERMF	89247A	42937	WALKERMF	89106A	44725	AP	89021C	49043	WALKERMF	929013K
41988	WALKERMF	89185A	42938	WALKERMF	89108A	44726	AP	89029C	49044	WALKERMF	89621K
41989	WALKERMF	89275A	42939	WALKERMF	89117A	44731	AP	89024A	49047	WALKERMF	929002A
41990	WALKERMF	89276A	42940	WALKERMF	89118A	44731	TRUCKEX	89024A	49048	WALKERMF	929003A
41991	WALKERMF	89186A	42944	WALKERMF	89109A	44732	AP	89051A	49049	WALKERMF	929004A
41992	WALKERMF	89248A	42944	WALKERMF	900057A	44734	AP	89051C	49050	WALKERMF	929005A
41993	WALKERMF	89167A	42978	WALKERMF	89897A	44735	AP	89054C	49052	WALKERMF	929007A
41994	WALKERMF	89187A	42993	SULLAIR	89435A	44737	AP	89037C	49056	WALKERMF	89678K
41995	WALKERMF	89277A	42993	SULLAIR	89435E	44773	AP	924027A	49060	WALKERMF	89620K
41996	WALKERMF	89163A	43049	WALKERMF	89901A	44773	TRUCKEX	924027A	49062	WALKERMF	89698K
41997	WALKERMF	89283A	43132	WALKERMF	89040A	44853	TRUCKEX	89042A	49063	WALKERMF	89626K

Cross Reference by Number

OEM No.	Manuf.	Our No.	OEM No.	Manuf.	Our No.	OEM No.	Manuf.	Our No.	OEM No.	Manuf.	Our No.
49064	WALKERMF	89688K	66899	NEWFLYER	89549K	102883	MAREMONT	49125A	180672	FWD	86125M
49065	WALKERMF	929025A	67362	ATHEY	49140A	102884	MAREMONT	49130A	181134	MILLEREL	89073A
49066	WALKERMF	929015K	68182	AP	89887A	102885	MAREMONT	49135A	194182	MOTORCO	89528W
49067	WALKERMF	929024A	68185	AP	89901A	102886	MAREMONT	10156T	194186	MOTORCO	89527K
49068	WALKERMF	929003A	68221	AP	926008A	102889	MAREMONT	49140A	197700	NEWHOLLA	86177M
49070	WALKERMF	89759K	68221	TRUCKEX	926008A	102890	MAREMONT	49150A	197721	FWD	86139M
49071	WALKERMF	89772K	70003	RIKER	86137M	102891	MAREMONT	86125M	199254	NEWHOLLA	86177M
49151	WALKERMF	929011A	70147	AUTOCAR	86300M	102892	MAREMONT	86148M	208852	DROTT	86150M
49159	WALKERMF	929025A	73331	FIELDQUE	86108M	102893	MAREMONT	86213M	210126	CRANECAR	86116M
49160	WALKERMF	929026A	74607	AP	926005A	102894	MAREMONT	86153M	211197	CUMMINS	86108M
49161	WALKERMF	929027A	74607	TRUCKEX	926005A	102895	MAREMONT	86185M	211206	CUMMINS	86133M
49162	WALKERMF	89688K	74608	AP	89986C	102896	MAREMONT	86510M	211212	CUMMINS	86144M
49165	WALKERMF	929016A	74609	AP	89989C	102898	MAREMONT	86511M	211213	CUMMINS	86145M
49166	WALKERMF	929001A	74627	AP	926011A	102899	MAREMONT	86505M	212362	CUMMINS	86139M
49177	WALKERMF	929038A	74632	AP	927010A	102901	MAREMONT	86529M	217149	HYSTER	86131M
49540	SULLAIR	86213M	74632	TRUCKEX	927010A	102902	MAREMONT	86131M	220817	DROTT	86139M
52033	WALKERMF	90987A	74638	AP	90447C	102974	MAREMONT	86536M	221322	DROTT	86106M
53017	WALKERMF	90979A	74646	AP	926072A	103021	MAREMONT	86537M	221499	DROTT	86133M
53018	WALKERMF	90980A	74646	TRUCKEX	926072A	103022	MAREMONT	86115M	221694	DROTT	86136M
53027	WALKERMF	924037A	80001	RIKER	20153T	106250	MAREMONT	86184M	222578	DROTT	86115M
53053	WALKERMF	89053A	80002	RIKER	20620T	106275	MAREMONT	86183M	224620	DROTT	86206M
53172	FWD	86125M	81004	RIKER	86132M	107415	LEACH	89146A	225317	KOHLER	49115U
54713	AP	89217C	81005	RIKER	86159M	107416	LEACH	89156A	230848	DROTT	86136M
54714	AP	89031C	81006	RIKER	86106M	108030	MAREMONT	86164M	231674	DROTT	86193M
54716	AP	89019C	81008	RIKER	86153M	108052	MAREMONT	86695M	236922	MINNPAR	89420A
54717	AP	89205A	81010	RIKER	86510M	108057	MAREMONT	86690M	241135	SULLAIR	49125A
54718	AP	89019A	81020	RIKER	86510M	108058	MAREMONT	86697M	241819	SULLAIR	49135A
54720	AP	89031A	81021	RIKER	86511M	108221	MAREMONT	10811T	245525	SULLAIR	86191M
54720	TRUCKEX	89031A	83000	AP	929016A	108222	MAREMONT	11026T	250632	ALLISCHA	14245T
54721	AP	89226A	83005	AP	929011A	108223	MAREMONT	11650T	251210	CUMMINS	86145M
54721	TRUCKEX	89226C	83005	TRUCKEX	929011A	108224	MAREMONT	11651T	251211	CUMMINS	86132M
54722	TRUCKEX	89143C	83008	AP	929012A	108225	MAREMONT	11669T	252063	BROCKWAY	90365A
54722	AP	89227A	83008	TRUCKEX	929012A	108227	MAREMONT	11731T	252178	CLARK	49135A
54723	AP	89226C	83009	AP	90579C	108229	MAREMONT	13900T	253237	KOHLER	86173M
54724	AP	89227C	83014	AP	929001A	108231	MAREMONT	14222T	265772	TEREX	86190M
54725	AP	89222A	83014	TRUCKEX	929001A	108232	MAREMONT	14472T	274649	KOHLER	89527K
54725	TRUCKEX	89222A	83016	AP	924005A	108233	MAREMONT	14490T	275679	KOHLER	48111U
54726	AP	89049A	83016	TRUCKEX	924005A	108234	MAREMONT	14663T	277679	KOHLER	49115U
54726	TRUCKEX	89049A	83028	AP	929027A	108236	MAREMONT	15088T	278621	KOHLER	49025N
54727	AP	89222C	83029	TRUCKEX	929038A	108237	MAREMONT	15572T	280842	MILLEREL	89091A
54736	AP	89215A	83030	TRUCKEX	929027A	108239	MAREMONT	17120T	280905	HYSTER	49120B
54745	AP	89221C	84548	AP	89987C	108240	MAREMONT	17275T	282894	HOBART	89114A
54809	AP	925002A	84550	AP	89990C	108241	MAREMONT	17704T	283666	MILLEREL	89165A
54809	TRUCKEX	925002A	84552	AP	929011A	108242	MAREMONT	18202T	283667	HOBART	89093A
54827	AP	90451A	84552	TRUCKEX	929011A	108243	MAREMONT	18901T	283865	MILLEREL	89095A
54828	AP	90451C	84563	AP	90449C	108247	MAREMONT	22150T	285253	MILLEREL	89185A
54829	AP	90452A	84569	AP	90448C	108249	MAREMONT	22152T	285254	MILLEREL	89105A
54830	AP	90452C	86200	DYNAFLEX	49120B	108252	MAREMONT	22705T	285276	MILLEREL	89166A
54844	AP	90444A	86250	DYNAFLEX	49125A	108255	MAREMONT	48111U	285284	MILLEREL	86144M
54880	AP	924037A	86300	DYNAFLEX	49130A	108257	MAREMONT	86177M	286687	MILLEREL	89102A
54880	TRUCKEX	924037A	86350	DYNAFLEX	49135A	108258	MAREMONT	86178M	286992	MILLEREL	89026A
54881	AP	90568C	86396	DAVEY	89422A	112352	FLXIBLE	86125M	287602	MILLEREL	89923A
54962	FWD	86108M	86400	DYNAFLEX	49140A	114053	FWD	86135M	287602	MILLEREL	89923C
54984	TRUCKEX	89205A	86500	DYNAFLEX	49150A	118055	THERMOKI	89559B	290933	BRIGGS&S	48111U
54985	TRUCKEX	89019A	86700	PACCAR	86700M	118073	MILLEREL	89430E	291772	AUTOCAR	86131M
54991	TRUCKEX	89217A	88528	MILLEREL	49115U	125640	KOEHRING	86135M	299477	BRIGGS&S	48111U
55057	WALKERMF	925070A	89029	AP	929038A	125656	KOEHRING	86168M	300902	DEUTZ	89543K
55057	WALKERMF	925071A	89058	PACCAR	89058A	125657	KOEHRING	49135A	310150	MAREMONT	89091A
55063	WALKERMF	925068A	90009	RIKER	86132M	125658	KOEHRING	86136M	310152	MAREMONT	89093A
55067	WALKERMF	925068A	90045	RIKER	86514M	125663	KOEHRING	86139M	310154	MAREMONT	89095A
56005	SICARD	86131M	92673	AP	89940A	125663	TEREX	86139M	310156	MAREMONT	89097A
58225	AP	926062A	92674	AP	89950A	125689	TEREX	89435E	315650	JOHNSTON	90384A
58251	AP	925014A	92679	AP	89941A	128903	WINNEBAG	89187A	315907	JOHNSTON	89435E
58251	TRUCKEX	925014A	92689	AP	89951A	131048	BLOUNT	89549K	315908	JOHNSTON	90385A
58285	AP	925005A	94006	RIKER	86133M	135370	GEHL	89090A	320290	MAREMONT	89124A
58319	AP	924004A	94007	RIKER	86213M	156815	CUMMINS	86108M	320293	MAREMONT	89117A
58330	AP	924008A	94014	RIKER	86180M	157082	CUMMINS	86125M	340362	MAREMONT	89021A
58330	TRUCKEX	924008A	94902	AP	90450C	159349	HYSTER	86125M	340363	MAREMONT	89051A
58349	TRUCKEX	925005A	97470	DROTT	86115M	164577	BLAWKNOX	89545K	340364	MAREMONT	89024A
58420	TRUCKEX	925070A	101861	MAREMONT	86139M	164579	BLAWKNOX	89021A	340366	MAREMONT	89027A
59902	GENERAC	89430E	101995	MAREMONT	86137M	164586	BLAWKNOX	89548K	340367	MAREMONT	89057A
59940	GENERAC	89435E	102608	MAREMONT	86136M	164590	BLAWKNOX	89547K	340368	MAREMONT	89030A
61066	INGRAM	90878A	102732	MAREMONT	86500M	164634	BLAWKNOX	89542K	377424	BLUEBIRD	86133M
61620	VERSATIL	48215U	102793	MAREMONT	86135M	164653	BLAWKNOX	89164A	390247	BRIGGS&S	48111U
64671	AP	89985A	102863	MAREMONT	86102M	164711	BLAWKNOX	89541K	391221	BRIGGS&S	48111U
64672	AP	89988C	102865	MAREMONT	86144M	164713	BLAWKNOX	89519K	407349	SULLAIR	49150A
64673	TRUCKEX	89985A	102866	MAREMONT	86188M	164784	BLAWKNOX	89098A	408546	MILLEREL	86193M
64673	AP	89985C	102867	MAREMONT	86189M	164785	BLAWKNOX	89101A	408547	MILLEREL	89184A
64745	AP	90570C	102872	MAREMONT	14245T	164786	BLAWKNOX	89105A	408594	MILLEREL	89103A
64746	AP	90905C	102875	MAREMONT	16487T	166395	GARDNER	86139M	408664	MILLEREL	89105A
65805	GENERAC	89450E	102882	MAREMONT	49120B	167650	NEWHOLLA	86178M	408770	MILLEREL	89102A

Cross Reference by Number

OEM No.	Manuf.	Our No.	OEM No.	Manuf.	Our No.	OEM No.	Manuf.	Our No.	OEM No.	Manuf.	Our No.
409132	BROCKWAY	86127M	520197	INSLEY	86137M	689398	UNIVCOCH	12036A	835866	WHITE	86108M
409885	BROCKWAY	86108M	520208	INSLEY	86173M	693298	BLUEBIRD	86137M	835866	VOLVO	86132M
414714	WALDON	86192M	520328	INSLEY	86132M	693298	GMC	86137M	836309	AMERHOIS	49140A
420019	PIERCEGO	89118A	520331	INSLEY	86106M	693299	BLUEBIRD	86164M	836310	AMERHOIS	86168M
420020	PIERCEGO	89101A	520371	INSLEY	86125M	693299	GMC	86164M	836841	VOLVO	89106A
420039	PIERCEGO	86102M	520372	INSLEY	86147M	693299	UNIVCOCH	86164M	837246	VOLVO	89714K
420076	PIERCEGO	89096A	520373	INSLEY	49140A	695224	GMC	86200M	840031	AMERHOIS	86153M
420159	PIERCEGO	89780A	520379	INSLEY	86139M	695423	GMC	86108M	844002	TRUCKEX	89021C
420193	PIERCEGO	89528K	521450	BROCKWAY	86102M	700002	GMC	86168M	844004	TRUCKEX	89030C
420198	PIERCEGO	89528K	524430	BROCKWAY	86685M	700710	VOLVO	89058C	844668	TRUCKEX	89057C
420199	PIERCEGO	89527K	528905	BROCKWAY	86108M	700745	VOLVO	89056A	844669	TRUCKEX	89045C
420200	PIERCEGO	89526B	531742	FWD	86125M	700746	VOLVO	89059A	844670	TRUCKEX	89060C
420200	PIERCEGO	89526K	532603	CLARK	86150M	700747	VOLVO	89045C	844734	TRUCKEX	89051C
420225	PIERCEGO	86125M	533938	FWD	86108M	700748	VOLVO	89060C	844735	TRUCKEX	89054C
420234	PIERCEGO	89510K	536907	MANITOWO	86173M	700752	VOLVO	89056C	844737	TRUCKEX	89037C
420256	PIERCEGO	86147M	536912	MANITOWO	86175M	700757	VOLVO	89950A	854000	TRUCKEX	925051C
420321	PIERCEGO	86203M	536917	MANITOWO	86125M	700757	VOLVO	89950C	854002	TRUCKEX	89027C
420365	PIERCEGO	89762K	536961	MANITOWO	86106M	700758	VOLVO	89027A	854716	TRUCKEX	89019C
420417	PIERCEGO	89664K	537890	WHITE	86147M	700760	VOLVO	89030A	854723	TRUCKEX	89226C
420434	PIERCEGO	89762K	539585	WHITE	86125M	700761	VOLVO	89027C	854724	TRUCKEX	89227C
420504	PIERCEGO	89537K	541362	BROCKWAY	86200M	700763	VOLVO	89030C	854727	TRUCKEX	89222C
420505	PIERCEGO	89942A	541565	BLOUNT	86144M	700768	VOLVO	49140A	857256	VOLVO	89104A
420622	PIERCEGO	89763K	543851	BROCKWAY	90354A	700870	VOLVO	89055C	857264	VOLVO	89151A
420801	PIERCEGO	86131M	545002	BLOUNT	23426N	701062	VOLVO	89166A	857278	VOLVO	89015A
420888	PIERCEGO	86145M	545115	WHITE	86131M	716540	KERSHAW	89643K	857415	VOLVO	89162A
420889	PIERCEGO	86194M	545546	CLARK	86132M	717202	GMC	86203M	857482	VOLVO	89161A
420908	PIERCEGO	89146C	545854	WHITE	86108M	717217	GMC	86200M	857585	VOLVO	89105A
420920	FWD	49140A	548140	MAREMONT	89274A	717976	VOLVO	89143A	857613	VOLVO	89055A
421268	PIERCEGO	89046A	548141	MAREMONT	89276A	718051	GMC	86200M	858622	VOLVO	89277A
421373	DON	89963K	548142	MAREMONT	89277A	722872	GMC	90376A	858623	VOLVO	89276A
421520	PIERCEGO	86148M	548143	MAREMONT	89163A	724859	BLUEBIRD	86164M	858626	VOLVO	89163A
422032	CHAMPION	86133M	548175	MAREMONT	89185A	724859	GMC	86164M	858630	VOLVO	86144M
422268	PIERCEGO	89519K	548176	MAREMONT	89172A	753833	LONG	89420A	858635	AGCO	89146A
422342	PIERCEGO	89730K	548180	MAREMONT	89186A	757883	KERSHAW	86148M	858639	VOLVO	89048A
422403	PIERCEGO	89043C	548181	MAREMONT	89173A	761841	LONG	89541K	858640	VOLVO	89108A
422612	MWM	89435E	548182	MAREMONT	89187A	773905	CAT	86159M	858641	VOLVO	89077A
422615	MWM	89440E	548184	MAREMONT	89278A	791365	LONG	89422A	858642	VOLVO	89074A
422979	PIERCEGO	89095A	549340	WHITE	86147M	791366	LONG	89542K	858643	VOLVO	89075A
424001	PIERCEGO	89099A	549803	EMERGEC	89950C	793920	GMC	90378A	858647	VOLVO	89187A
424002	PIERCEGO	89103A	550098	CRANECAR	89762K	796790	BLUEBIRD	86164M	858648	VOLVO	89186A
424003	PIERCEGO	89106A	552249	WHITE	86132M	796790	GMC	86164M	859699	FREIGHTL	89450E
424013	PIERCEGO	89094A	561649	SICARD	86168M	798803	GMC	86213M	864000	TRUCKEX	89293C
424026	PIERCEGO	89094A	561767	SICARD	86125M	805335	AMERHOIS	86175M	864001	TRUCKEX	89296C
425151	PIERCEGO	89501K	561819	SICARD	86147M	806237	AMERHOIS	86125M	864671	TRUCKEX	89985C
426474	PIERCEGO	89187A	563109	BLOUNT	89545K	806556	LONG	86177M	864672	TRUCKEX	89988C
427170	CLARK	86175M	565243	BLOUNT	89548K	807002	AMERHOIS	86172M	870373	CAT	89926A
437930	FWD	90368A	578013	NEWHOLLA	89547K	808164	AMERHOIS	86180M	870377	CAT	89924A
447803	WHITE	86125M	606699	AGCHEMEQ	89740K	809406	TRUCKEX	89106C	870383	CAT	89058A
458764	RACINE	48215U	617211	EAGLEPIC	89547K	809546	TRUCKEX	89107C	870504	CAT	89771K
496696	FWD	49150A	619077	AUTOCAR	86135M	809547	TRUCKEX	89784C	874000	TRUCKEX	89294C
501803	CLARK	86159M	629780	WHITE	86108M	809736	TRUCKEX	89780C	874001	TRUCKEX	89298C
505881	DROTT	86168M	632578	NEWHOLLA	89430E	809738	TRUCKEX	89781C	874608	TRUCKEX	89986C
506959	VOGEL	90904A	637982	NEWHOLLA	89025A	809739	TRUCKEX	89075C	874609	TRUCKEX	89989C
507064	CLARK	86173M	638256	NEWHOLLA	89440E	809770	TRUCKEX	89105C	884000	TRUCKEX	89295C
508420	DROTT	86106M	638451	NEWHOLLA	89440A	809771	TRUCKEX	89924C	884001	TRUCKEX	90526C
508699	DROTT	86159M	638451	NEWHOLLA	89440E	809796	TRUCKEX	89117C	884548	TRUCKEX	89987C
508708	WHITE	86139M	638960	NEWHOLLA	89548K	814261	DYNAPAC	89544K	884550	TRUCKEX	89990C
510118	BROCKWAY	86102M	642050	FWD	49125A	814621	TRUCKEX	89143C	891137	VOLVO	89715K
510320	MAREMONT	89505K	643984	AUTOCAR	86135M	814622	TRUCKEX	89144C	892851	VOLVO	900356S
512736	BROCKWAY	86125M	649297	WHITE	86108M	814623	TRUCKEX	90909C	892940	VOLVO	89057C
514436	AGCHEMEQ	89027A	651360	WHITE	86125M	815613	BLUEBIRD	86108M	900201	DYNAPAC	89440A
514985	AGCHEMEQ	89252A	651995	GMC	86133M	815613	BLUEBIRD	86630M	900201	DYNAPAC	89440E
515355	AGCHEMEQ	89217A	651996	GMC	86133M	816839	VOLVO	89214A	911753	CABOT	86180M
515380	AGCHEMEQ	86102M	651997	GMC	86133M	816840	VOLVO	89216A	911778	CABOT	86175M
515397	AGCHEMEQ	89780A	658900	GMC	86108M	817066	CAT	86130M	911784	CABOT	86173M
515461	AGCHEMEQ	89501K	660098	GMC	86125M	824002	TRUCKEX	89052C	916185	THERMOKI	89559B
515804	AGCHEMEQ	86102M	660901	GMC	86131M	824701	TRUCKEX	89218C	916185	THERMOKI	89559K
516140	BROCKWAY	86131M	661997	GMC	86133M	824715	TRUCKEX	89145C	921097	DYNAPAC	89547K
516154	AGCHEMEQ	89021A	661998	GMC	86133M	824716	TRUCKEX	89146C	921150	DYNAPAC	89543K
516164	AGCHEMEQ	89021A	663283	GMC	86102M	824721	TRUCKEX	89155C	921170	DYNAPAC	89548K
516523	AGCHEMEQ	86514M	663284	GMC	86102M	824722	TRUCKEX	89156C	924120	TRUCKEX	90906A
516534	AGCHEMEQ	86131M	666800	GMC	86118M	824749	TRUCKEX	89043C	925502	AP	89963K
516554	AGCHEMEQ	89046A	675490	WHITE	86139M	824751	TRUCKEX	89046C	926002	AP	89664K
516678	AGCHEMEQ	89749C	679399	GMC	86118M	824757	TRUCKEX	89055C	928002	AP	89666K
516679	AGCHEMEQ	89766K	680400	TOWMOTOR	86137M	824758	TRUCKEX	89058C	929087	DYNAPAC	89786K
516719	AGCHEMEQ	90452A	680401	TOWMOTOR	86168M	834000	TRUCKEX	89053C	980263	CAT	89440A
516754	AGCHEMEQ	89724K	680402	TOWMOTOR	86125M	834004	TRUCKEX	89026C	980263	CAT	89440E
516754	AGCHEMEQ	89724P	682154	GMC	86152M	834005	TRUCKEX	89029C	980845	CAT	89435E
516920	AGCHEMEQ	89097A	685217	GMC	86108M	834708	TRUCKEX	89017C	993915	BLUEBIRD	90868A
517485	WHITE	86147M	686607	CAT	89420A	834725	TRUCKEX	89036C	997791	BLUEBIRD	89513K
519021	JOY	86173M	687135	GMC	86118M	834746	TRUCKEX	89056C	998580	WHITE	86108M

Cross Reference by Number

OEM No.	Manuf.	Our No.	OEM No.	Manuf.	Our No.	OEM No.	Manuf.	Our No.	OEM No.	Manuf.	Our No.
1004983	SIMONDPX	86168M	1411314	PETERBIL	86130M	1908022	STEMCO	86183M	1909542	STEMCO	86512M
1005321	BLUEBIRD	924004A	1411434	PETERBIL	90358A	1908250	STEMCO	86137M	1909545	STEMCO	86153M
1006376	SIMONDPX	89094A	1413055	PETERBIL	900121A	1909004	STEMCO	86186M	1909548	STEMCO	86185M
1006820	SIMONDPX	89450A	1414794	GARDNERD	86220M	1909006	STEMCO	86136M	1909550	STEMCO	86505M
1006820	SIMONDPX	89450E	1436146	BLUEBIRD	86195M	1909010	STEMCO	86136M	1909550	STEMCO	86664M
1007191	SIMONDPX	89046C	1436161	BLUEBIRD	89731K	1909013	STEMCO	86187M	1909551	STEMCO	86506M
1007751	VOLVO	89766K	1436400	OSHKOSH	89186A	1909017	STEMCO	86136M	1909553	STEMCO	86536M
1017030	GRIMMERS	86190M	1466929	BLUEBIRD	89145A	1909022	STEMCO	86136M	1909608	STEMCO	86135M
1017391	ELGNSWPR	86119M	1468099	BLUEBIRD	86108M	1909057	STEMCO	86136M	1909700	STEMCO	86137M
1017515	ELGNSWPR	89546K	1477538	BLUEBIRD	923042A	1909063	STEMCO	86137M	1909702	STEMCO	86137M
1020649	VOLVO	89156A	1477629	BLUEBIRD	924005A	1909065	STEMCO	86136M	1909703	STEMCO	86137M
1025552	VOLVO	86132M	1477637	BLUEBIRD	924005A	1909103	STEMCO	86187M	1909801	STEMCO	86127M
1026315	ELGNSWPR	89430E	1477645	BLUEBIRD	924005A	1909105	STEMCO	86188M	1909808	STEMCO	86560M
1026437	ELGNSWPR	89614K	1488910	OSHKOSH	86130M	1909121	STEMCO	20153T	1909809	STEMCO	86127M
1026439	ELGNSWPR	89164A	1505943	CLARK	86139M	1909122	STEMCO	86150M	1909823	STEMCO	86195M
1029948	BLOUNT	89550K	1510991	JACKSONV	86139M	1909123	STEMCO	86144M	1909851	STEMCO	86530M
1030036	ELGNSWPR	89545K	1512238	CLARK	86133M	1909129	STEMCO	86189M	1909853	STEMCO	86118M
1030039	ELGNSWPR	89525K	1513792	CLARK	86168M	1909131	STEMCO	86137M	1909855	STEMCO	86133M
1030040	ELGNSWPR	89613K	1514083	CLARK	86119M	1909135	STEMCO	86173M	1909858	STEMCO	86672M
1030624	ELGNSWPR	86213M	1517514	CLARK	49160A	1909147	STEMCO	86127M	1909860	STEMCO	86148M
1032027	ELGNSWPR	89440A	1517515	CLARK	49150A	1909156	STEMCO	86164M	1909864	STEMCO	86118M
1032027	ELGNSWPR	89440E	1517516	CLARK	86180M	1909159	STEMCO	86164M	1909869	STEMCO	86120M
1032173	ELGNSWPR	89083A	1518825	CLARK	86115M	1909167	STEMCO	86137M	1909870	STEMCO	86200M
1034636	ELGNSWPR	89541K	1519325	CLARK	86102M	1909170	STEMCO	86164M	1909870	STEMCO	86215M
1034713	ELGNSWPR	89420A	1522291	BLUEBIRD	86130M	1909171	STEMCO	86164M	1909871	STEMCO	86215M
1034713	INGERSOL	89420A	1543567	CLARK	86147M	1909174	STEMCO	86137M	1909872	STEMCO	86130M
1034730	ELGNSWPR	89110A	1550817	CLARK	86172M	1909202	STEMCO	86127M	1909872	STEMCO	86196M
1034730	INGERSOL	89110A	1552046	ONAN	89430E	1909204	STEMCO	86127M	1909876	STEMCO	86115M
1038482	ELGNSWPR	89549K	1552908	ONAN	49120B	1909208	STEMCO	86119M	1909885	STEMCO	86430M
1042053	ELGNSWPR	89114A	1553181	ONAN	89450E	1909208	STEMCO	86139M	1909885	STEMCO	86700M
1042956	ELGNSWPR	89728K	1553372	ONAN	90092A	1909210	STEMCO	86119M	1909887	STEMCO	86168M
1043371	ELGNSWPR	90443A	1566204	DODGE	86136M	1909234	STEMCO	86127M	1909892	STEMCO	86130M
1043683	ELGNSWPR	89527K	1569180	OSHKOSH	49110U	1909241	STEMCO	86184M	1909896	STEMCO	86712M
1046126	ELGNSWPR	89544K	1569318	BLUEBIRD	89790K	1909245	STEMCO	86183M	1909926	STEMCO	86149M
1046473	BLUEBIRD	89942A	1569326	BLUEBIRD	89550K	1909247	STEMCO	86185M	1920677	DODGE	86135M
1046508	ELGNSWPR	90552A	1569425	BLUEBIRD	86610M	1909248	STEMCO	86185M	1934041	DODGE	86127M
1048015	ELGNSWPR	89542K	1575836	BLUEBIRD	86543M	1909250	STEMCO	86183M	1934042	DODGE	86127M
1051411	ELGNSWPR	89543K	1712190	OSHKOSH	86148M	1909251	STEMCO	86183M	1946300	OSHKOSH	90359A
1056805	ELGNSWPR	90873A	1796899	CLARK	86213M	1909300	STEMCO	86713M	1946300	OSHKOSH	90359B
1056876	ELGNSWPR	90895A	1808048	KENWORTH	89075A	1909303	STEMCO	86144M	1997964	BLUEBIRD	86547M
1056877	ELGNSWPR	89965K	1838180	OSHKOSH	89626K	1909305	STEMCO	86561M	2002206	GMC	86195M
1058863	ELGNSWPR	89125A	1900204	STEMCO	86186M	1909306	STEMCO	86108M	2002655	GMC	86153M
1062109	ELGNSWPR	89113A	1900206	STEMCO	86187M	1909310	STEMCO	86145M	2004200	GMC	90355A
1068102	CAT	86191M	1900404	STEMCO	86186M	1909315	STEMCO	86188M	2006718	GMC	86195M
1097987	CAT	90352A	1900406	STEMCO	86187M	1909316	STEMCO	86560M	2008782	GMC	86137M
1097987	CAT	90352B	1900414	STEMCO	86186M	1909327	STEMCO	86739M	2010001	STEMCO	89261A
1100279	CUMMINS	86139M	1901102	STEMCO	86305M	1909333	STEMCO	86175M	2010003	STEMCO	89263A
1111110	Volvo	86682M	1901107	STEMCO	86682M	1909336	STEMCO	86108M	2010005	STEMCO	89261A
1111863	BLUEBIRD	89623K	1901125	STEMCO	86149M	1909341	STEMCO	86113M	2010014	STEMCO	89160A
1116639	Volvo	86526M	1901133	STEMCO	86220M	1909344	STEMCO	86118M	2010031	STEMCO	89263A
1118626	ALLISCHA	86177M	1901138	STEMCO	86557M	1909345	STEMCO	86113M	2010041	STEMCO	89161A
1120405	JLGI	89435E	1901140	STEMCO	86705M	1909348	STEMCO	86108M	2010061	STEMCO	89162A
1120423	JLGI	89440E	1901141	STEMCO	86655M	1909349	STEMCO	86108M	2010069	STEMCO	89163A
1121729	CAT	894125A	1901144	STEMCO	86220M	1909352	STEMCO	86630M	2010114	STEMCO	89266A
1155562	GARDNERD	49120B	1901149	STEMCO	86672M	1909353	STEMCO	86108M	2011272	STEMCO	89160A
1177300	CAT	89543K	1901150	STEMCO	86653M	1909354	STEMCO	86102M	2011274	STEMCO	89161A
1204201	PETTIBON	86192M	1901156	STEMCO	86213M	1909355	STEMCO	86408M	2011275	STEMCO	89162A
1240228	TEREX	89546K	1901157	STEMCO	86153M	1909356	STEMCO	86402M	2011276	STEMCO	89163A
1250844	BLUEBIRD	86132M	1901160	STEMCO	86106M	1909362	STEMCO	86300M	2011503	GMC	90363A
1267939	BLUEBIRD	86168M	1901172	STEMCO	86194M	1909374	STEMCO	86402M	2013323	GMC	86526M
1289040	BLUEBIRD	86557M	1901173	STEMCO	86606M	1909376	STEMCO	86113M	2013323	VOLVO	86526M
1326196	CAT	89541K	1901175	STEMCO	86116M	1909377	STEMCO	86740M	2014355	GARDNERD	86191M
1326476	CAT	89541K	1901176	STEMCO	86116M	1909400	STEMCO	86125M	2016573	GARDNERD	86147M
1332386	BLUEBIRD	924005A	1901179	STEMCO	86655M	1909401	STEMCO	86147M	2020001	STEMCO	89420A
1334226	BLUEBIRD	89571K	1901180	STEMCO	86139M	1909408	STEMCO	86685M	2020006	STEMCO	89422A
1338128	BLUEBIRD	89622K	1901181	STEMCO	86545M	1909410	STEMCO	86147M	2020012	STEMCO	89425A
1343136	CAT	89460A	1901187	STEMCO	86544M	1909416	STEMCO	86115M	2020022	STEMCO	89427A
1357342	BLUEBIRD	924037A	1901204	STEMCO	86526M	1909419	STEMCO	86116M	2020108	STEMCO	89435A
1357359	BLUEBIRD	924037A	1901205	STEMCO	86535M	1909450	STEMCO	86503M	2020134	STEMCO	89440A
1394592	BLUEBIRD	86196M	1901205	STEMCO	86547M	1909451	STEMCO	86608M	2020144	STEMCO	89450A
1394600	BLUEBIRD	86145M	1901208	STEMCO	86529M	1909460	STEMCO	86608M	2020200	STEMCO	89420A
1404055	PETERBIL	90993A	1901208	STEMCO	86644M	1909500	STEMCO	86106M	2020225	STEMCO	89422A
1405055	PETERBIL	90993A	1901220	STEMCO	86542M	1909505	STEMCO	86153M	2020249	GMC	86195M
1409456	PETERBIL	90081A	1901221	STEMCO	86548M	1909515	STEMCO	86562M	2020250	STEMCO	89425A
1409456	PETERBIL	90082A	1901223	STEMCO	86535M	1909528	STEMCO	86213M	2020275	STEMCO	89427A
1410133	BLUEBIRD	924037A	1901223	STEMCO	86547M	1909532	STEMCO	86512M	2020350	STEMCO	89435A
1410726	PETERBIL	90465A	1901230	STEMCO	86672M	1909537	STEMCO	86510M	2020384	STEMCO	89445A
1410726	PETERBIL	90465C	1901231	STEMCO	86626M	1909538	STEMCO	86153M	2020385	STEMCO	89460A
1411039	PETERBIL	89514K	1901934	STEMCO	86115M	1909539	STEMCO	86505M	2020400	STEMCO	89440A
1411054	PETERBIL	90081A	1902490	CLARK	49135A	1909539	STEMCO	86664M	2020450	STEMCO	89445A
1411054	PETERBIL	90082A	1904790	OSHKOSH	89218C	1909542	STEMCO	86213M	2020500	STEMCO	89450A

Cross Reference by Number

OEM No.	Manuf.	Our No.	OEM No.	Manuf.	Our No.	OEM No.	Manuf.	Our No.	OEM No.	Manuf.	Our No.
2020600	STEMCO	89460A	2090986	STEMCO	89537K	2131850	STEMCO	89609K	2151250	STEMCO	89730K
2020805	AGCO	90366B	2090986	STEMCO	90863K	2132430	STEMCO	89601K	2151840	STEMCO	89727K
2021028	STEMCO	89440C	2090987	STEMCO	90843K	2132435	STEMCO	89604K	2151850	STEMCO	89731K
2021029	STEMCO	89450C	2092903	EATONYAL	49135A	2132440	STEMCO	89607K	2152440	STEMCO	89728K
2021400	STEMCO	89440C	2093622	EATONYAL	86119M	2132520	STEMCO	89708K	2152530	STEMCO	89721K
2021500	STEMCO	89450C	2095002	EATONYAL	86106M	2132525	STEMCO	89710K	2152535	STEMCO	89722K
2021600	STEMCO	89460C	2100002	STEMCO	89537K	2132530	STEMCO	89712K	2152540	STEMCO	89723K
2022825	GMC	86130M	2100003	STEMCO	89551K	2132535	STEMCO	89713K	2152550	STEMCO	89724K
2023482	GMC	90354A	2100123	CRANECAR	86108M	2132540	STEMCO	89714K	2152560	STEMCO	89725K
2023483	GMC	90358A	2100134	CRANECAR	86531M	2132550	STEMCO	89715K	2153640	STEMCO	89729K
2030130	GMC	90368A	2100146	STEMCO	89543K	2132560	STEMCO	89716K	2153650	STEMCO	89733K
2030131	GMC	90364A	2100148	CRANECAR	86514M	2133120	BLUEBIRD	86136M	2154036	STEMCO	89729K
2030132	GMC	90365A	2100153	STEMCO	89535K	2133630	STEMCO	89602K	2155036	STEMCO	89733K
2030134	GMC	90363A	2100161	STEMCO	89536K	2133635	STEMCO	89605K	2160002	STEMCO	89071A
2030202	STEMCO	89271A	2100167	STEMCO	89538K	2133640	STEMCO	89608K	2160039	STEMCO	89071A
2030208	STEMCO	89274A	2100180	STEMCO	89539K	2133650	STEMCO	89611K	2160056	STEMCO	89073A
2030212	STEMCO	89276A	2100338	STEMCO	89540K	2140018	STEMCO	89642K	2160065	STEMCO	89077A
2030213	STEMCO	89277A	2100989	STEMCO	89771K	2140052	STEMCO	89643K	2160070	STEMCO	900064A
2030214	STEMCO	89278A	2100991	STEMCO	89761K	2140057	STEMCO	89644K	2161012	STEMCO	89781C
2030401	STEMCO	89275A	2100993	STEMCO	89763K	2140071	STEMCO	89645K	2161126	STEMCO	89073A
2030812	GMC	86200M	2100995	STEMCO	89766K	2140525	STEMCO	89710K	2161127	STEMCO	89077A
2031275	STEMCO	89276A	2101000	STEMCO	89767K	2140530	STEMCO	89712K	2161128	STEMCO	900064A
2031276	STEMCO	89277A	2102130	OSHKOSH	86194M	2140535	STEMCO	89713K	2161146	STEMCO	89074A
2031281	STEMCO	89278A	2110221	STEMCO	89773K	2140540	STEMCO	89714K	2161147	STEMCO	89075A
2033269	GMC	86130M	2118156	BLUEBIRD	929007A	2140550	STEMCO	89715K	2170003	STEMCO	89110A
2033626	EATONYAL	86173M	2119295	GMC	929027A	2140554	STEMCO	89601K	2170004	STEMCO	89231A
2042783	EATONYAL	86150M	2119352	GMC	929027A	2140555	STEMCO	89602K	2170005	STEMCO	89111A
2046594	GMC	86505M	2119485	BLUEBIRD	929007A	2140558	STEMCO	89604K	2170006	STEMCO	89233A
2046609	GMC	86505M	2119675	BLUEBIRD	929027A	2140559	STEMCO	89605K	2170147	STEMCO	89110A
2046609	GMC	86664M	2119683	BLUEBIRD	929027A	2140560	STEMCO	89716K	2170151	STEMCO	89231A
2050002	STEMCO	89940A	2119691	BLUEBIRD	929027A	2140561	STEMCO	90903K	2170156	STEMCO	89111A
2050019	STEMCO	89940A	2119709	BLUEBIRD	929027A	2140562	STEMCO	89607K	2170160	STEMCO	89233A
2050032	STEMCO	89950A	2120035	STEMCO	89744C	2140563	STEMCO	89608K	2170166	STEMCO	89234A
2050657	STEMCO	89951A	2120945	STEMCO	89744C	2140565	STEMCO	90902K	2170171	STEMCO	89114A
2050933	STEMCO	89942A	2120946	STEMCO	89744C	2140567	STEMCO	89611K	2170174	STEMCO	89115A
2055366	AGCO	90368B	2120981	STEMCO	89748A	2140802	STEMCO	89600K	2170179	STEMCO	89118A
2055371	CAT	90885A	2120984	STEMCO	89748A	2140803	STEMCO	89603K	2170182	STEMCO	89113A
2057214	GMC	86153M	2120986	STEMCO	89744C	2140804	STEMCO	89606K	2170194	STEMCO	89116A
2058727	GMC	86506M	2120987	STEMCO	89744C	2140806	STEMCO	89609K	2170203	STEMCO	89117A
2060001	STEMCO	89549K	2120995	STEMCO	90555C	2140934	STEMCO	89641K	2170380	STEMCO	89925A
2060004	STEMCO	89541K	2130010	STEMCO	89640K	2141030	STEMCO	90191K	2170494	STEMCO	89116A
2060011	STEMCO	89542K	2130013	STEMCO	89648K	2141035	STEMCO	90206K	2170507	STEMCO	900063A
2060016	STEMCO	89543K	2130015	STEMCO	89641K	2141040	STEMCO	89759K	2170663	STEMCO	89123A
2060025	STEMCO	89544K	2130017	STEMCO	89647K	2141050	STEMCO	89722K	2170971	STEMCO	89115A
2060030	STEMCO	89545K	2130020	STEMCO	89640K	2141540	STEMCO	89760K	2170972	STEMCO	89118A
2060036	STEMCO	89546K	2130022	STEMCO	89648K	2141550	STEMCO	89773K	2170974	STEMCO	900062A
2060042	STEMCO	89547K	2130023	STEMCO	89642K	2141568	STEMCO	89309K	2170975	STEMCO	89117A
2060063	STEMCO	89548K	2130025	STEMCO	89641K	2141569	STEMCO	89313K	2170992	STEMCO	900062A
2060072	STEMCO	89549K	2130026	STEMCO	89643K	2141572	STEMCO	89310K	2170996	STEMCO	900063A
2060350	STEMCO	90092A	2130027	STEMCO	89647K	2141573	STEMCO	89314K	2171004	STEMCO	89117C
2061470	GMC	86130M	2130030	STEMCO	89642K	2141840	STEMCO	89309K	2171006	STEMCO	89094A
2069207	GMC	86153M	2130035	STEMCO	89643K	2141850	MACK	89313K	2171013	STEMCO	900059A
2069773	GMC	89508K	2130038	STEMCO	89644K	2141850	STEMCO	89313K	2171015	STEMCO	900061A
2070196	STEMCO	89558K	2130040	STEMCO	89644K	2142440	STEMCO	89310K	2180004	STEMCO	89098A
2070201	MACK	89559B	2130043	STEMCO	89645K	2142450	STEMCO	89314K	2180040	STEMCO	89098A
2070201	MACK	89559K	2130050	STEMCO	89645K	2142540	STEMCO	89760K	2180049	STEMCO	89099A
2070201	STEMCO	89559K	2130060	STEMCO	89646K	2142550	STEMCO	89773K	2180054	STEMCO	89232A
2070215	STEMCO	89560K	2130330	STEMCO	89712K	2150066	STEMCO	89624K	2180058	STEMCO	89102A
2071276	STEMCO	89568K	2130335	STEMCO	89713K	2150400	STEMCO	89625K	2180062	STEMCO	89104A
2071277	STEMCO	89569K	2130340	STEMCO	89714K	2150521	STEMCO	89626K	2180064	STEMCO	89106A
2071283	STEMCO	89570K	2130350	STEMCO	89715K	2150651	STEMCO	89623K	2180067	STEMCO	89108A
2072019	EATONYAL	86147M	2130360	STEMCO	89716K	2150671	STEMCO	89622K	2180075	STEMCO	89101A
2076550	EATONYAL	86139M	2130520	STEMCO	89708K	2150730	STEMCO	89721K	2180079	STEMCO	900053A
2079900	GMC	86504M	2130523	STEMCO	89646K	2150735	STEMCO	89722K	2180081	STEMCO	89105A
2079904	GMC	86506M	2130525	STEMCO	89710K	2150740	STEMCO	89723K	2180084	STEMCO	89107A
2080012	STEMCO	90927K	2130530	STEMCO	89712K	2150750	STEMCO	89724K	2180096	STEMCO	90459A
2080034	STEMCO	90928K	2130535	STEMCO	89713K	2150760	STEMCO	89725K	2180381	STEMCO	89784A
2080078	STEMCO	90914K	2130540	STEMCO	89714K	2150810	STEMCO	89727K	2180488	STEMCO	900055A
2080089	STEMCO	90929K	2130550	STEMCO	89715K	2150812	STEMCO	89731K	2180508	STEMCO	900057A
2080094	STEMCO	90915K	2130560	STEMCO	89716K	2150867	STEMCO	89621K	2181002	STEMCO	89105C
2080099	STEMCO	90916K	2131025	STEMCO	89641K	2150878	STEMCO	89728K	2181003	STEMCO	89106C
2080102	STEMCO	89544K	2131030	STEMCO	89642K	2150881	STEMCO	89730K	2181006	STEMCO	89107C
2080103	STEMCO	89545K	2131035	STEMCO	89643K	2150906	STEMCO	89624K	2181124	STEMCO	90460A
2080105	STEMCO	89547K	2131040	STEMCO	89644K	2150912	STEMCO	89620K	2181125	STEMCO	89102A
2080107	STEMCO	89548K	2131050	STEMCO	89645K	2151020	STEMCO	89620K	2181126	STEMCO	89104A
2080109	STEMCO	89549K	2131060	STEMCO	89646K	2151025	STEMCO	89621K	2181127	STEMCO	89106A
2081801	FMC	86159M	2131240	STEMCO	90903K	2151030	STEMCO	89622K	2181128	STEMCO	89108A
2089643	EATONYAL	49130A	2131250	STEMCO	90902K	2151035	STEMCO	89623K	2181129	STEMCO	89101A
2090696	STEMCO	89519K	2131830	STEMCO	89600K	2151040	STEMCO	89624K	2181130	STEMCO	89103A
2090697	STEMCO	89519K	2131835	STEMCO	89603K	2151050	STEMCO	89625K	2181131	STEMCO	89105A
2090985	STEMCO	90863K	2131840	STEMCO	89606K	2151060	STEMCO	89626K	2181132	STEMCO	89107A

Cross Reference by Number

OEM No.	Manuf.	Our No.	OEM No.	Manuf.	Our No.	OEM No.	Manuf.	Our No.	OEM No.	Manuf.	Our No.
2181136	STEMCO	89901A	2260801	FMC	86177M	2306635	BLUEBIRD	86136M	2426136	STEMCO	89223C
2181153	STEMCO	900057A	2261270	OSHKOSH	86610M	2306635	GMC	86136M	2426148	STEMCO	89224C
2181154	STEMCO	89784A	2269681	FMC	86136M	2310240	STEMCO	89740K	2426596	STEMCO	90449C
2181194	STEMCO	89784A	2270253	STEMCO	89211A	2310254	STEMCO	89742K	2427177	GMC	86137M
2190002	STEMCO	929013K	2270257	STEMCO	89214A	2310367	STEMCO	89623K	2427277	GMC	86139M
2190003	STEMCO	89697K	2270260	STEMCO	89216A	2318076	PETTIBON	86192M	2428242	GMC	86137M
2190004	STEMCO	929014K	2270271	STEMCO	89218A	2320002	STEMCO	90539A	2430001	STEMCO	89082A
2190005	STEMCO	90615K	2270542	STEMCO	89025A	2320322	STEMCO	90538A	2430002	STEMCO	89081A
2190093	STEMCO	89670K	2270544	STEMCO	89212A	2320631	STEMCO	90539A	2430003	STEMCO	89240A
2190101	STEMCO	89697K	2270547	STEMCO	89022A	2320632	STEMCO	90534A	2430005	STEMCO	89086A
2190106	STEMCO	89671K	2270551	STEMCO	89028A	2320941	STEMCO	90533A	2430263	STEMCO	89081A
2190110	STEMCO	90615K	2270565	STEMCO	89020A	2320942	STEMCO	90537A	2430266	STEMCO	89240A
2190113	STEMCO	89672K	2270566	STEMCO	89026A	2321070	CLARK	86137M	2430273	STEMCO	89082A
2190118	STEMCO	89673K	2270573	STEMCO	89023A	23253719	GMC	90913A	2430278	STEMCO	89083A
2190125	STEMCO	89674K	2270574	STEMCO	89029A	2374637	GMC	86115M	2430283	STEMCO	900068A
2190128	STEMCO	89675K	2270577	STEMCO	89021A	2380903	STEMCO	89020C	2430286	STEMCO	89782A
2190132	STEMCO	89679K	2270578	STEMCO	89027A	2380904	STEMCO	89021C	2430492	STEMCO	89782A
2190143	STEMCO	89676K	2270585	STEMCO	89024A	2380906	STEMCO	89026C	2430614	STEMCO	89084A
2190345	STEMCO	89678K	2270586	STEMCO	89030A	2380907	STEMCO	89027C	2430615	STEMCO	89085A
2191040	STEMCO	89759K	2270589	STEMCO	89213A	2380908	STEMCO	89217C	2430616	STEMCO	89783A
2199800	BLUEBIRD	86137M	2270590	STEMCO	89217A	2380909	STEMCO	89029C	2434175	BLUEBIRD	86137M
2199800	GMC	86137M	2270598	STEMCO	89031A	2380910	STEMCO	89030C	2434175	GMC	86137M
2200086	STEMCO	89661K	2270951	STEMCO	89006A	2380911	STEMCO	89031C	2440001	STEMCO	89249A
2200087	STEMCO	89662K	2270957	STEMCO	89014A	2382391	GMC	86139M	2440002	STEMCO	89250A
2200092	STEMCO	89663K	2270958	STEMCO	89015A	2383254	GMC	86115M	2440191	STEMCO	89164A
2200098	STEMCO	89664K	2270959	STEMCO	89205A	2390713	STEMCO	90866A	2440192	STEMCO	89165A
2201032	STEMCO	89665K	2270960	STEMCO	89017A	2390714	STEMCO	89547K	2440200	STEMCO	89166A
2201080	STEMCO	89666K	2270961	STEMCO	89018A	2390715	STEMCO	90867A	2440204	STEMCO	89167A
2210003	STEMCO	89141A	2270962	STEMCO	89019A	2390716	STEMCO	90868A	2440602	STEMCO	89252A
2210120	STEMCO	89141A	2276136	STEMCO	89219A	2390728	STEMCO	89550K	2440753	STEMCO	89249A
2210131	STEMCO	89143A	2280806	STEMCO	929005A	2392391	GMC	86139M	2440754	STEMCO	89250A
2210141	STEMCO	89144A	2280841	STEMCO	929026A	2393290	BLUEBIRD	86137M	2440758	STEMCO	89251A
2210148	STEMCO	89145A	2280865	STEMCO	929016A	2393290	GMC	86137M	2440759	STEMCO	89166A
2210154	STEMCO	89146A	2280873	STEMCO	929005A	2393291	GMC	86139M	2440762	STEMCO	89164A
2210696	STEMCO	89144A	2280937	STEMCO	929003A	2400749	STEMCO	89256A	2444889	BLUEBIRD	86137M
2210697	STEMCO	89145A	2280951	STEMCO	929016A	2400860	STEMCO	89881A	2444889	GMC	86137M
2210698	STEMCO	89146A	2280952	STEMCO	929016A	2400865	STEMCO	89883A	2450001	STEMCO	929002A
2218000	STEMCO	89147A	2280959	STEMCO	89205A	2403031	TAYLORMA	86139M	2450002	STEMCO	929003A
2220003	STEMCO	89151A	2280960	STEMCO	926005A	2403034	TAYLORMA	86131M	2450003	STEMCO	929004A
2220119	STEMCO	89151A	2280964	STEMCO	929011A	2403036	TAYLORMA	86175M	2450004	STEMCO	929024A
2220124	STEMCO	89153A	2280965	STEMCO	929011A	2403037	TAYLORMA	86125M	2450498	GMC	86115M
2220130	STEMCO	89154A	2280966	STEMCO	929011A	2403044	TAYLORMA	86108M	2450724	STEMCO	929004A
2220133	STEMCO	89155A	2280968	STEMCO	929011A	2403054	TAYLORMA	86200M	2450726	STEMCO	89685K
2220136	STEMCO	89156A	2280969	STEMCO	929011A	2403107	TAYLORMA	86115M	2450726	STEMCO	929025A
2220967	STEMCO	89155A	2280970	STEMCO	929011A	2403348	TAYLORMA	86119M	2450728	STEMCO	89686K
2220979	STEMCO	89154A	2281013	STEMCO	929026A	2403748	TAYLORMA	89195U	2450729	STEMCO	89687K
2220981	STEMCO	90913A	2281066	STEMCO	925002A	2407607	GMC	86106M	2450730	STEMCO	929007A
2220984	STEMCO	89153A	2281069	STEMCO	929012A	2420982	STEMCO	90450C	2450732	STEMCO	89688K
2220985	STEMCO	89043A	2281099	STEMCO	929007A	2421144	STEMCO	89146C	2450962	STEMCO	89019A
2220989	STEMCO	89156A	2281154	STEMCO	929007A	2421281	STEMCO	89155C	2451231	STEMCO	929002A
2227915	DODGE	86136M	2281159	STEMCO	924037A	2421282	STEMCO	89145C	2451261	STEMCO	929002A
2229617	DODGE	86136M	2281160	STEMCO	924037A	2421283	STEMCO	89156C	2451262	STEMCO	929003A
2229768	DODGE	86127M	2281172	STEMCO	924037A	2421285	STEMCO	89053C	2451282	STEMCO	89698K
2229769	DODGE	86135M	2281177	STEMCO	926011A	2421287	STEMCO	89056C	2453809	BLUEBIRD	86136M
2240164	STEMCO	89045A	2281180	STEMCO	924037A	2421291	STEMCO	89054C	2453809	GMC	86136M
2240176	STEMCO	89044A	2281180	STEMCO	929004A	2421292	STEMCO	89045C	2453865	GMC	86139M
2240463	STEMCO	89047A	2281183	STEMCO	929011A	2421293	STEMCO	89057C	2456787	GMC	86133M
2240470	STEMCO	89048A	2281193	STEMCO	927010A	2421295	STEMCO	89060C	2458005	STEMCO	929035S
2240762	STEMCO	89164A	2281194	STEMCO	929001A	2421296	STEMCO	89222C	2458006	STEMCO	929036S
2240878	STEMCO	89222A	2281197	STEMCO	929016A	2421297	STEMCO	89226C	2458015	STEMCO	929005A
2240880	STEMCO	89049A	2281198	STEMCO	929016A	2421299	STEMCO	89227C	2458729	STEMCO	929035S
2240882	STEMCO	89043A	2281202	STEMCO	926072A	2421300	STEMCO	89293C	2458732	STEMCO	929036S
2240883	STEMCO	89046A	2281239	STEMCO	923042A	2421301	STEMCO	89985C	2460823	DODGE	86136M
2244018	STEMCO	89155A	2281256	STEMCO	924005A	2421302	STEMCO	89296C	2482970	GMC	86108M
2244072	STEMCO	89293A	2281282	STEMCO	925005A	2421303	STEMCO	89988C	2482972	GMC	86200M
2245072	STEMCO	89296A	2288355	HYSTER	86108M	2421304	STEMCO	89294C	2483764	GMC	86200M
2250205	STEMCO	89959K	2290220	STEMCO	89091A	2421305	STEMCO	89986C	2485787	GMC	86139M
2250207	STEMCO	89961K	2290224	STEMCO	89093A	2421307	STEMCO	89989C	2488074	BLUEBIRD	86137M
2250943	STEMCO	89967K	2290227	STEMCO	89095A	2421308	STEMCO	89295C	2488074	GMC	86137M
2250944	STEMCO	89964K	2290229	STEMCO	89097A	2421309	STEMCO	89987C	2488076	GMC	86139M
2251094	STEMCO	89971K	2290232	STEMCO	900082A	2421310	STEMCO	89298C	2488077	GMC	86148M
2251095	STEMCO	89955K	2290660	STEMCO	89236A	2421311	STEMCO	89990C	2493031	TAYLORMA	86139M
2251096	STEMCO	89958K	2291610	STEMCO	900081A	2421317	STEMCO	900089C	2500001	STEMCO	89508K
2251097	STEMCO	89960K	2291735	STEMCO	900073A	2421402	STEMCO	89043C	2500002	STEMCO	89509K
2251254	STEMCO	89965K	2295978	GMC	89509K	2421403	STEMCO	89055C	2500004	STEMCO	89531K
2251259	STEMCO	89966K	2298024	STEMCO	900077A	2421404	STEMCO	89046C	2500013	STEMCO	89532K
2251260	STEMCO	89963K	2298026	STEMCO	900085A	2421405	STEMCO	89058C	2500014	STEMCO	89502K
2251262	STEMCO	89959K	2298036	STEMCO	900078A	2423714	GMC	86139M	2500016	STEMCO	89512K
2251263	STEMCO	89967K	2298037	STEMCO	900069A	2424277	GMC	86139M	2500017	STEMCO	89520K
2251264	STEMCO	89958K	2298038	STEMCO	900086A	2426018	STEMCO	89147C	2500020	STEMCO	89571K
2251265	STEMCO	89962K	2306634	GMC	86137M	2426036	STEMCO	89228C	2500021	STEMCO	89530K

Cross Reference by Number

OEM No.	Manuf.	Our No.	OEM No.	Manuf.	Our No.	OEM No.	Manuf.	Our No.	OEM No.	Manuf.	Our No.
2500022	STEMCO	89573K	2680008	STEMCO	89528W	2740125	STEMCO	90452C	3919773	VOLVO	89527K
2500023	STEMCO	89520K	2681420	STEMCO	90350A	2740126	STEMCO	90444A	3919774	VOLVO	89528K
2500638	STEMCO	89511K	2681425	STEMCO	90352A	2740127	STEMCO	90444C	3919775	VOLVO	89549K
2500639	STEMCO	89512K	2681427	STEMCO	90353A	2740148	STEMCO	90979A	3919776	VOLVO	89559B
2500640	STEMCO	89513K	2681430	STEMCO	90354A	2740150	STEMCO	90980A	3919776	VOLVO	89559K
2500900	STEMCO	89505K	2681435	STEMCO	90355A	2740165	STEMCO	900065A	3919777	VOLVO	89744C
2500901	STEMCO	89506K	2681450	STEMCO	90358A	2740176	STEMCO	90981A	3919779	VOLVO	89749C
2500902	STEMCO	89507K	2681522	STEMCO	90361A	2740190	STEMCO	900121A	3919781	VOLVO	89771K
2500930	STEMCO	89500K	2681527	STEMCO	90363A	2740201	STEMCO	89899A	3919782	VOLVO	89784A
2500931	MACK	89503K	2681530	STEMCO	90364A	2740268	STEMCO	924037A	3919783	VOLVO	89924A
2500931	STEMCO	89503K	2681535	STEMCO	90365A	2740271	STEMCO	90987A	3919784	VOLVO	89766K
2500970	STEMCO	89514K	2681545	STEMCO	90367A	2774082	CLARK	89519K	3919785	VOLVO	89767K
2501017	STEMCO	89510K	2681550	STEMCO	90368A	2774995	CLARK	89021A	3919786	VOLVO	86131M
2501278	STEMCO	89501K	2681560	STEMCO	90369A	2775014	CLARK	89525K	3919787	VOLVO	86137M
2501280	STEMCO	90531K	2681825	STEMCO	90352A	2775015	CLARK	89613K	3928084	BLUEBIRD	86137M
2501710	CLARK	86213M	2681830	STEMCO	90354A	2776570	CLARK	49120B	3928084	GMC	86137M
2501803	CLARK	86159M	2681835	STEMCO	90355A	2786446	CLARK	89522K	3930268	BLUEBIRD	86136M
2505995	DODGE	86133M	2681850	STEMCO	90358A	2793205	CLARK	49130A	3930268	GMC	86136M
2506865	DODGE	86136M	2681850	MACK	90368A	2793505	TEREX	89519K	3931391	GMC	86137M
2508001	STEMCO	89533K	2681850	MACK	90368B	2812167	CLARK	89541K	3931392	GMC	86137M
2508346	DODGE	86136M	2681930	STEMCO	90364A	2817356	CLARK	89545K	3941446	BLUEBIRD	86136M
2510883	CLARK	86206M	2681935	STEMCO	90365A	2817357	CLARK	90869A	3941446	GMC	86136M
2520846	STEMCO	89017C	2681950	STEMCO	90368A	2818526	CLARK	49125A	3941447	BLUEBIRD	86137M
2520848	STEMCO	89019C	2682430	STEMCO	90374A	2821257	CLARK	89571K	3941447	GMC	86137M
2521781	CLARK	49135A	2682435	STEMCO	90375A	2831025	DODGE	86108M	3941448	GMC	86137M
2530189	STEMCO	89057A	2682440	STEMCO	90376A	2907822	CLARK	86168M	3941457	BLUEBIRD	86137M
2530198	STEMCO	89056A	2682450	STEMCO	90378A	2907822	DODGE	86168M	3941457	GMC	86137M
2530466	STEMCO	89059A	2682460	STEMCO	90379A	2909336	DODGE	86108M	3946774	VOLVO	90388A
2530468	STEMCO	89060A	2683520	STEMCO	89521K	2941448	BLUEBIRD	86137M	3946774	VOLVO	90388B
2530894	STEMCO	89226A	2683522	STEMCO	89522K	2971502	DODGE	86115M	3946776	VOLVO	90386A
2530896	STEMCO	89227A	2683525	STEMCO	89523K	2975915	DODGE	86139M	3946776	VOLVO	90386B
2530976	STEMCO	89055A	2683527	STEMCO	89524K	3061656	ALLISCHA	86119M	3946777	VOLVO	90368A
2530977	STEMCO	89058A	2683530	STEMCO	89525K	3061668	ALLISCHA	86139M	3946777	VOLVO	90368B
2531697	CLARK	86153M	2683535	STEMCO	89526K	3086612	VOLVO	89198U	3946778	VOLVO	90366B
2534018	STEMCO	89145A	2683540	STEMCO	89527K	3127500	PRIMEMOV	86177M	3946779	VOLVO	86131M
2534072	STEMCO	89985A	2683550	STEMCO	89528K	3130895	VOLVO	89731K	3946780	VOLVO	86682M
2536036	STEMCO	89223A	2683560	STEMCO	89529K	3250018	GROVE	49120B	3948169	VOLVO	900356S
2550003	STEMCO	89283A	2690040	STEMCO	89132A	3278969	OSHKOSH	90531K	3948308	Volvo	89049A
2550005	STEMCO	89279A	2690044	STEMCO	89133A	3420089	PIERCEGO	89238A	3948357	VOLVO	89272K
2550152	STEMCO	89182A	2704542	BLUEBIRD	929007A	3420620	PIERCEGO	86133M	3954016	BLUEBIRD	86136M
2550157	STEMCO	89184A	2705036	STEMCO	89993C	3459884	DODGE	86139M	3954016	GMC	86136M
2550162	STEMCO	89186A	2705048	STEMCO	89994C	3634560	DODGE	86108M	3954017	BLUEBIRD	86137M
2550168	STEMCO	89187A	2705060	STEMCO	90438C	3638397	DODGE	86102M	3954017	GMC	86137M
2550897	STEMCO	89279A	2705085	GMC	929027A	3657316	CLARK	89614K	3954018	GMC	86164M
2550929	DODGE	86125M	2705119	GMC	929027A	3693710	BLUEBIRD	86136M	3954019	BLUEBIRD	86137M
2554030	STEMCO	89185A	2715096	STEMCO	90442C	3693710	GMC	86136M	3954020	GMC	86164M
2555240	DODGE	86127M	2715120	STEMCO	90604C	3724300	BLUEBIRD	86136M	3954021	BLUEBIRD	86137M
2557506	CLARK	86116M	2716508	STEMCO	90577C	3724300	GMC	86136M	3954021	GMC	86137M
2558162	STEMCO	89172A	2716596	STEMCO	90576C	3741399	BLUEBIRD	86136M	3963833	GMC	86137M
2558168	STEMCO	89173A	2720001	STEMCO	90465C	3741399	GMC	86136M	3970714	VOLVO	86531M
2560636	STEMCO	89246A	2720002	STEMCO	90465A	3816360	BLUEBIRD	86136M	3973651	VOLVO	27023A
2560637	STEMCO	89247A	2730182	STEMCO	926008A	3816360	GMC	86136M	3981941	GMC	86137M
2560752	STEMCO	89248A	2730185	STEMCO	925014A	3816361	BLUEBIRD	86136M	3981948	GMC	86136M
2572001	VERMEER	89153A	2730186	STEMCO	926008A	3816361	GMC	86136M	3989647	GMC	86137M
2580996	STEMCO	89775K	2730204	STEMCO	89880A	3820392	DODGE	86108M	4003012	CMICORP	86180M
2581371	STEMCO	90993A	2730329	STEMCO	924027A	3821787	DODGE	86136M	4064641	MILLEREL	49115U
2621058	STEMCO	49115U	2730363	STEMCO	925014A	3828126	DODGE	86102M	4064642	MILLEREL	49120B
2621059	STEMCO	49120B	2730364	STEMCO	926008A	3850422	BLUEBIRD	86136M	4064644	MILLEREL	49125A
2621060	STEMCO	49125A	2730399	STEMCO	924005A	3850422	GMC	86136M	4101256	ONAN	89450E
2621061	STEMCO	49130A	2730409	STEMCO	926062A	3850423	GMC	86136M	4204307	KOEHRING	86175M
2621062	STEMCO	49135A	2730416	STEMCO	923008A	3850424	BLUEBIRD	86137M	4204310	KOEHRING	86125M
2621063	STEMCO	49140A	2730417	STEMCO	924004A	3850424	GMC	86137M	4204351	KOEHRING	86139M
2621064	STEMCO	49150A	2730418	STEMCO	925005A	3873128	GMC	86137M	4204360	KOEHRING	86133M
2621065	STEMCO	49160A	2730419	STEMCO	89600K	3890258	BLUEBIRD	86136M	4204373	KOEHRING	86119M
2622015	STEMCO	49115U	2730422	STEMCO	926062A	3890258	GMC	86136M	4204376	KOEHRING	86108M
2622020	STEMCO	49120B	2730423	STEMCO	924008A	3890340	BLUEBIRD	86136M	4204378	KOEHRING	86213M
2622025	STEMCO	49125A	2730424	STEMCO	926008A	3890340	GMC	86136M	4204404	KOEHRING	86193M
2622030	STEMCO	49130A	2730429	STEMCO	90966A	3904077	BLUEBIRD	86137M	4204753	TEREX	86187M
2622035	STEMCO	49135A	2730430	STEMCO	89603K	3904077	GMC	86137M	4405147	PARTEK	89195U
2622040	STEMCO	49140A	2730431	STEMCO	90967A	3907220	GMC	86139M	4420045	PIERCEGO	89971K
2622050	STEMCO	49150A	2730494	STEMCO	89892A	3917656	CUMMINS	89430E	4420047	PIERCEGO	89097A
2622060	STEMCO	49160A	2740016	STEMCO	90823A	3917673	CUMMINS	89440E	4607688	TEREX	89056C
2646503	BLUEBIRD	929007A	2740020	STEMCO	89897A	3917826	CUMMINS	89545K	4607689	TEREX	89527K
2672155	FMC	86137M	2740021	STEMCO	90922A	3919708	VOLVO	90358A	4619365	TEREX	89215A
2672158	FMC	86139M	2740022	STEMCO	89887A	3919766	VOLVO	86514M	5015767	NORTHAME	90904A
2672159	FMC	86168M	2740032	STEMCO	90913A	3919767	VOLVO	86526M	5020398	GMC	89514K
2672160	FMC	86131M	2740064	STEMCO	90938A	3919768	VOLVO	89103A	5100006	CUMMINS	89685K
2679303	FMC	86132M	2740072	STEMCO	90983A	3919769	VOLVO	89107A	5108720	GMC	86175M
2680005	STEMCO	89525W	2740122	STEMCO	90451A	3919770	VOLVO	89145A	5119172	GMC	86172M
2680006	STEMCO	89526W	2740123	STEMCO	90451C	3919771	VOLVO	89145C	5119173	GMC	86173M
2680007	STEMCO	89527W	2740124	STEMCO	90452A	3919772	VOLVO	89146C	5127284	DETROITD	89542K

Cross Reference by Number

OEM No.	Manuf.	Our No.	OEM No.	Manuf.	Our No.	OEM No.	Manuf.	Our No.	OEM No.	Manuf.	Our No.
5132650	INTERNL	89510K	10771010	ORIONBUS	89502K	46665796	BUCYRUSE	86102M	73137579	AGCO	89450A
5157178	EATONYAL	86136M	11642501	WINNEBAG	90910C	46665797	BUCYRUSE	86175M	73137579	AGCO	89450E
5179058	GMC	86175M	12462838	GRIMMERS	49125A	46665799	BUCYRUSE	86145M	73162052	VERMEER	89571K
5179206	GMC	86173M	12974168	INGERSOL	89250A	48423000	WINCO	48210U	76009164	WARNERSW	86173M
5181515	GMC	86172M	13065271	INGERSOL	89218A	49014270	WHITE	86108M	76018489	WARNERSW	49130A
5198957	FMC	49130A	15507925	GMC	89624K	49014271	VOLVO	86108M	76020614	WARNERSW	86177M
5292627	CLARK	86159M	15521179	GMC	86130M	49014272	WHITE	86108M	76022356	WARNERSW	86139M
5323221	GILLIG	90358A	15549646	GMC	86557M	49014272	VOLVO	86108M	76026291	WARNERSW	86147M
5840209	GARDNER	86193M	15552174	GMC	86724M	49014272	WHITE	86108M	76032138	WARNERSW	86133M
5952263	AMGENRL	12036A	15555594	GMC	86557M	49014273	WHITE	86108M	76034174	SIMONDPX	89549K
5987323	AMGENRL	86132M	15571897	GMC	21063A	49033350	VOLVO	86102M	76050043	SIMONDPX	89528K
6002355	CLARK	86168M	15572769	GMC	86727M	49033350	WHITE	86102M	76052628	SIMONDPX	86125M
6515915	MELROE	49120B	15572770	GMC	86727M	49034554	VOLVO	86102M	76052630	SIMONDPX	86130M
6519594	MELROE	12417T	15572771	GMC	86723M	49034554	WHITE	86102M	76052631	SIMONDPX	86132M
6662242	GARDNER	49025N	15572772	GMC	86723M	49037185	WHITE	86200M	76052633	SIMONDPX	86147M
6670562	MELROE	Q186201	15609879	GMC	86724M	49037199	WHITE	86102M	76055103	SIMONDPX	49150A
6751378	AMERLAFR	86125M	15628117	GMC	86756M	49037855	WHITE	86115M	76056606	SIMONDPX	86125M
6812826	MINNPAR	86177M	15638767	BLUEBIRD	86722M	49039300	VOLVO	86102M	76059914	SIMONDPX	89187A
7013934	FREIGHTL	89450E	15638767	GMC	86722M	49039300	WHITE	86102M	76061884	SIMONDPX	89231A
7095789	KOEHRING	86192M	15647159	GMC	89520K	49039302	WHITE	86145M	76062077	SIMONDPX	89156C
7095969	TEREX	89430E	15658354	GMC	86725M	49039303	WHITE	86195M	76064799	SIMONDPX	89283A
7120512	TEREX	89167A	15670818	GMC	86722M	49039308	WHITE	86200M	76064800	SIMONDPX	86180M
7630695	SNORKEL	90572A	15982892	GMC	86724M	49044073	WHITE	86130M	76064801	SIMONDPX	89550K
7800027	TAYLORMA	86192M	16006166	FWD	86135M	49045022	WHITE	86130M	76064802	SIMONDPX	89236A
8022803	VOLVO	24809A	16006168	FWD	86139M	49046994	WHITE	86215M	76064986	SIMONDPX	89094A
8060101	VOLVO	89535K	16006172	FWD	86125M	49047016	WHITE	86200M	76064987	SIMONDPX	89096A
8060103	VOLVO	86188M	16457900	BLAWKNOX	89021A	49550060	FREIGHTL	89019C	76065597	SIMONDPX	89146C
8060123	VOLVO	89547K	16478500	BLAWKNOX	89101A	50001551	KOEHRING	86106M	76066306	SIMONDPX	89784A
8070241	VOLVO	86535M	19040276	MOTORCO	90531K	50001561	KOEHRING	86137M	76066706	SIMONDPX	89925A
8070241	VOLVO	86547M	19040290	MOTORCO	90887A	50742078	ORIONBUS	89558K	84000778	TEREX	89050A
8108216	EATONYAL	86148M	19040357	MCI	90872A	50774247	ORIONBUS	90531K	84000778	TEREX	89050C
8332126	INGERSOL	89440E	20354705	VOLVO	86117A	50774273	ORIONBUS	90887A	85071213	WARNERSW	86173M
9013928	GMC	86147M	20387751	VOLVO	28071A	50774275	ORIONBUS	90877A	86534869	NEWHOLLA	89559B
9013928	TEREX	86147M	20726071	ORIONBUS	90873A	50774277	ORIONBUS	89519K	86534869	NEWHOLLA	89559K
9214205	TEREX	49160A	20778041	ORIONBUS	89513K	51910213	JOY	86173M	86546727	NEWHOLLA	89050C
9307658	ELGNSWPR	89440A	23001056	WHITE	86130M	51910214	JOY	86180M	86571017	WARNERSW	49140A
9307658	ELGNSWPR	89440E	23460286	CONSOLDI	89440E	51910218	JOY	86177M	86681083	WARNERSW	86136M
9404319	ISUZU	86690M	23505035	DETROITD	89559B	52795491	FMC	89115A	87200136	DYNAFLEX	86136M
9505995	DODGE	86133M	23505035	DETROITD	89559K	58979778	INGERSOL	86147M	87200177	DYNAFLEX	86177M
9949979	KOEHRING	86131M	23513833	DETROITD	89544K	59179226	INGERSOL	89543K	87250186	DYNAFLEX	86186M
9963125	LODAL	86772M	23570014	RAYGO	86153M	59354100	INGERSOL	89187A	87300119	DYNAFLEX	86119M
10000137	CUMMINS	89164A	23570018	RAYGO	86159M	59362582	INGERSOL	89055A	87300187	DYNAFLEX	86187M
10000139	CUMMINS	25582N	23570031	RAYGO	86193M	59392266	INGERSOL	89193U	87350113	DYNAFLEX	86113M
10000171	CUMMINS	25922N	24921330	WARNERSW	86139M	59394288	INGERSOL	86191M	87400108	DYNAFLEX	86108M
10000176	CUMMINS	89166A	26020229	WIS CON	90368B	59428201	INGERSOL	86148M	87400120	DYNAFLEX	86108M
10000201	CUMMINS	89211A	26020230	WISCONSIN	89016C	59430025	INGERSOL	89167A	87400127	DYNAFLEX	86127M
10000321	CUMMINS	Q186112	27076523	WHITE	86119M	59590224	INGERSOL	89166A	87400131	DYNAFLEX	86131M
10000819	BLOUNT	89550K	27076528	WHITE	86119M	59607549	INGERSOL	89056A	87500102	DYNAFLEX	86102M
10002042	BLOUNT	86108M	27076530	WHITE	86512M	59693432	INGERSOL	89544K	87500130	DYNAFLEX	86130M
10002139	BLOUNT	89923A	27076535	WHITE	86203M	59693564	INGERSOL	89422A	87500132	DYNAFLEX	86132M
10002139	BLOUNT	89923C	27076537	WHITE	86133M	59710301	INGERSOL	89030A	87500145	DYNAFLEX	86145M
10002140	BLOUNT	89275A	27076541	WHITE	86125M	59758623	INGERSOL	86168M	88400133	DYNAFLEX	86133M
10002214	SICARD	86177M	27076544	WHITE	86132M	59764142	INGERSOL	89547K	89250137	DYNAFLEX	86137M
10002256	SICARD	86132M	27076545	WHITE	86200M	59764159	INGERSOL	89186A	89300139	DYNAFLEX	86139M
10002433	BLOUNT	89101A	27076551	VOLVO	86300M	59764225	INGERSOL	89165A	89350106	DYNAFLEX	86106M
10002435	BLOUNT	86139M	27076551	WHITE	86300M	59764233	INGERSOL	89092A	89400054	DYNAFLEX	86153M
10002438	BLOUNT	89430E	27137738	WHITE	86200M	59845784	INGERSOL	89119A	89500125	DYNAFLEX	86125M
10004266	BLOUNT	89144A	27138775	VOLVO	86148M	60774504	ORIONBUS	90887A	89400153	DYNAFLEX	86153M
10004693	BLOUNT	89185A	27138775	WHITE	86148M	61000071	METROTRO	90368B	90002071	OTTAWA	89440E
10008010	BLOUNT	89103A	29234562	MORBARK	86191M	61240005	THOMASBB	86147M	90200519	GRADALL	11026T
10008013	BLOUNT	89547K	29323025	MORBARK	49115U	61240007	THOMASBB	86115M	90205815	GRADALL	49125A
10008318	BLOUNT	89685K	29323082	MORBARK	86148M	61240008	THOMASBB	86125M	92622025	STEMCO	49125A
10009552	BLOUNT	89670K	29334119	GORMANRU	86136M	61240207	THOMASBB	89531K	92622030	STEMCO	49130A
10009625	BLOUNT	89671K	29334134	GORMANRU	86173M	61240386	THOMASBB	90910A	92622035	STEMCO	49135A
10009664	BLOUNT	89674K	31100390	AUTOCAR	86300M	61370302	THOMASBB	89545K	92622040	STEMCO	49140A
10013902	BLOUNT	90354A	35107192	INGERSOL	86137M	62104527	NORTHWEN	49160A	92622050	STEMCO	49150A
10025725	BLOUNT	86200M	35109107	INGERSOL	86125M	62785030	CLARK	86144M	94037873	GMC	89143A
10029077	BLOUNT	89675K	35113539	INGERSOL	86139M	65004938	THOMASBB	89145A	94037873	ISUZU	89143A
10031706	BLOUNT	89543K	35576721	INGERSOL	86192M	70229531	AGCO	05388T	94044319	GMC	86690M
10033083	BLOUNT	89113A	35673022	JAEGER	86172M	70237290	DEUTZ	14245T	94044319	ISUZU	86690M
10033566	BLOUNT	89698K	35673580	JAEGER	86173M	70261975	AGCO	18202T	94047627	GMC	86690M
10051093	BLOUNT	89525K	35797877	INGERSOL	86206M	70261975	ALLISCHA	18202T	94047627	ISUZU	86690M
10051128	BLOUNT	89512K	35846484	INGERSOL	89430E	71362829	DEUTZ	89187A	100703005	UNIVCOCH	19141N
10175432	FWD	86173M	35857036	INGERSOL	89450E	71362830	DEUTZ	89277A	114596000	FREIGHTL	89503K
10175510	FWD	86108M	38228126	DODGE	86102M	71381507	AGCO	89923A	155003803	GMC	86200M
10175578	FWD	86131M	42023149	JDEERE	12417T	71381507	AGCO	89923C	155242904	ONAN	49025N
10175581	FWD	86102M	42026436	JDEERE	12417T	72527255	AGCO	89730K	155252701	ONAN	49125A
10175623	FWD	86150M	46652000	BUCYRUSE	86131M	73061656	FIATALLS	86119M	155252702	ONAN	49130A
10444214	INGERSOL	86192M	46653350	BUCYRUSE	86125M	73061656	MINNPAR	86119M	155311101	ONAN	89425A
10638782	GMC	89520K	46664250	BUCYRUSE	86172M	73061668	FIATALLS	86139M	155311102	ONAN	89430E
10640231	GMC	89507K	46665250	BUCYRUSE	86173M	73121453	ALLISCHA	49140A	155311103	ONAN	89430E

Cross Reference by Number

OEM No.	Manuf.	Our No.	OEM No.	Manuf.	Our No.	OEM No.	Manuf.	Our No.	OEM No.	Manuf.	Our No.
155609879	GMC	86724M	700587300	TIMBERJA	89519K	7642000054	GROVE	86130M	143350S	AMGENRL	90368A
203403600	ORENSTEI	89101A	700623400	TIMBERJA	86133M	7642000608	GROVE	49150A	143660C1	CASE	17120T
206466700	TEREX	89569K	700708242	AGCO	20680T	7642000614	GROVE	49140A	144057C5	CASE	17275T
230010002	WHITE	86108M	750838800	EATONYAL	49115U	7642000616	GROVE	49120B	1495014M1	MASSEY	86173M
230010003	WHITE	86200M	750839800	EATONYAL	49120B	7642000620	GROVE	86119M	1518317C1	INTERNTL	86547M
230010004	WHITE	86102M	810367400	TIMBERJA	89548K	7642000623	GROVE	86526M	1608381C1	INTERNTL	926072A
230010005	VOLVO	86108M	845100207	KOEHRING	86173M	7642000628	GROVE	86556M	1608681C1	INTERNTL	926005A
230010005	WHITE	86108M	846100205	KOEHRING	86172M	7697001024	GROVE	89059A	160907A	WHITE	86190M
230010010	VOLVO	86200M	846100207	KOEHRING	86173M	7697001584	GROVE	89218A	1609419C1	INTERNTL	86102M
230010010	WHITE	86200M	846100209	KOEHRING	86177M	7697001585	GROVE	89058A	1610293C3	INTERNTL	927010A
230010027	VOLVO	86125M	846100243	KOEHRING	86139M	7734000100	GROVE	89256A	1610299C3	INTERNTL	929001A
230010027	WHITE	86125M	846100247	KOEHRING	86139M	7734000101	GROVE	89274A	1616478C1	INTERNTL	86606M
230010031	VOLVO	86116M	846100273	KOEHRING	86137M	7814001026	GROVE	89774C	1616657C1	INTERNTL	86753M
230010035	VOLVO	86115M	846100292	KOEHRING	86106M	7910015066	GROVE	89240A	1618487C2	INTERNTL	929038A
230010040	VOLVO	86108M	846100304	KOEHRING	86192M	7910015358	GROVE	89794K	1618490C2	INTERNTL	929038A
230010040	WHITE	86108M	874050514	DYNAFLEX	86740M	7910016250	GROVE	89047A	161WA533	CLARK	86139M
230010041	WHITE	86130M	902455001	VERMEER	89427A	9047570011	VERMEER	89052A	1622155C2	INTERNTL	86755M
230010044	VOLVO	86130M	906020011	VERMEER	89624K	12908713530	YANMAR	89420A	164080A	COCKSHUT	10156T
230010044	WHITE	86130M	938690011	VERMEER	89151A	12908713540	YANMAR	89541K	1647375C1	INTERNTL	86533M
230010047	WHITE	86195M	938780011	VERMEER	86191M	19002480004	SULLIVAN	89440E	1647960C1	INTERNTL	86538M
230010051	WHITE	86203M	949044343	WHITE	86195M	50174500005	YALETOWN	89435E	1647960C1	INTERNTL	86185M
230010052	WHITE	86200M	1026239191	VERMEER	89687K	50174500020	GARDNER	89440E	1647960C2	INTERNTL	86538M
230010053	VOLVO	86116M	1037310011	VERMEER	89050C	80998441650	VOLVO	90358A	1647961C2	INTERNTL	86536M
230010062	VOLVO	86115M	1225720011	VERMEER	89153A	80998441650	VOLVO	90358B	1647998C1	INTERNTL	86631M
230010064	WHITE	86130M	1240703004	J&J	19141N	81974456012	MAN	89528K	1647998C1	INTERNTL	86631M
230010076	VOLVO	86547M	1252380011	VERMEER	89430E	87113800001	FLXIBLE	86147M	1647998C2	INTERNTL	86536M
230010080	VOLVO	86531M	1310031081	ATLASCPC	O186201	436031401900	NORTHAME	89450E	1647999C1	INTERNTL	86545M
230010083	VOLVO	86196M	1310032059	ATLASCPC	90361A	02-7076561	AP	89527W	1647999C2	INTERNTL	86545M
230010084	VOLVO	86196M	1310034562	ATLASCPC	89182A	02-7076562	AP	89528W	1648000C1	INTERNTL	86537M
230013209	VOLVO	86606M	1310038237	ATLASCPC	89435E	10019W	RIKER	86200M	1648000C2	INTERNTL	86537M
230013215	WESTSTAR	86196M	2032510011	VERMEER	49140A	10023W	RIKER	86200M	1648038C1	INTERNTL	86607M
230013220	VOLVO	22286A	2032520011	VERMEER	89155A	10038G	OSHKOSH	86180M	1648039C1	INTERNTL	86751M
230013222	VOLVO	86753M	2070168230	KOMATSU	89527K	101159229A	GRIMMERS	86136M	1648056C1	INTERNTL	86757M
230013409	WHITE	86195M	2120401292	REX	86102M	10154F	OSHKOSH	86139M	1652937C1	INTERNTL	89889A
230013410	WHITE	86130M	2140870011	VERMEER	89055A	10297GX	OSHKOSH	89560B	1653532C1	INTERNTL	925005A
230013411	WHITE	86130M	2201005578	BLUEBIRD	90352A	103417A	OLIVER	14245T	1657101C1	INTERNTL	89882A
230013417	WHITE	86195M	2201124783	BLUEBIRD	90354A	103978C2	CASE	15088T	1657101C2	INTERNTL	89882A
230013420	WHITE	86130M	2250091785	SULLAIR	49150A	105G	OSHKOSH	86131M	1657433C1	INTERNTL	86545M
230013427	WESTSTAR	86130M	2408020011	VERMEER	89612K	106337C4	CASE	14490T	1657433C2	INTERNTL	86545M
230013429	WESTSTAR	86196M	2408030011	VERMEER	89101A	106B4943	EIMCO	86139M	1657434C1	INTERNTL	86537M
230013430	VOLVO	86531M	2447680011	VERMEER	90913A	107789B	OSHKOSH	86130M	1657436C1	INTERNTL	86547M
230013430	WESTSTAR	86531M	2811005560	BLUEBIRD	90355A	108435H45	HOUGH	86521M	1657436C2	INTERNTL	86547M
230013431	WESTSTAR	86712M	2811250299	BLUEBIRD	89560K	109820B	OSHKOSH	86130M	1658111C1	INTERNTL	86751M
230013432	WESTSTAR	86700M	2811250851	BLUEBIRD	90358A	10A18924	WHITE	89440E	1662057C1	INTERNTL	89521K
230013807	WHITE	86130M	2980518392	REX	86213M	10MG10S4	PACCAR	90461C	1662058C1	INTERNTL	89522K
230013823	VOLVO	22833A	4420210002	PIERCEGO	89740K	10MG20S4	PACCAR	89749C	1662059C1	INTERNTL	89523K
230018001	VOLVO	23557A	4571000318	CEDARRAP	90562A	10MG30S4	PACCAR	89774C	1662060C1	INTERNTL	89524K
230018002	VOLVO	23558A	5000444758	MACK	86608M	10MG31S3	PACCAR	89745C	1662061C1	INTERNTL	89525K
235043432	WESTSTAR	90887A	5315440000	GILLIG	89519K	10MG40S4	PACCAR	89995C	1662062C1	INTERNTL	89526K
235095001	VOLVO	89107A	5316224000	GILLIG	86153M	10MG41S3	PACCAR	89996C	1662063C1	INTERNTL	89527K
235200005	VOLVO	90354A	5324892000	GILLIG	86147M	10UH2	PACCAR	89540K	1662064C1	INTERNTL	90464K
235200006	VOLVO	90355A	5324895000	GILLIG	89551K	110792A	OSHKOSH	89146C	1662065C1	INTERNTL	89529K
235200008	VOLVO	90358A	5325434200	GILLIG	86149M	110B070240	DINA	90378B	1664453C2	INTERNTL	86754M
235200014	VOLVO	90547K	5330349000	GILLIG	86133M	110B070205	DINA	90358B	1666966C2	INTERNTL	924008A
235200015	VOLVO	90546K	5335644000	GILLIG	86570M	111641B	OSHKOSH	49150A	1668838C1	INTERNTL	925005A
235273440	WESTSTAR	900123A	5525755000	GILLIG	86542M	119144H	BLUEBIRD	86139M	1668841C2	INTERNTL	929016A
235283472	WESTSTAR	89198U	6814910000	FREIGHTL	86196M	119144H	INTERNTL	86139M	1668843C1	INTERNTL	929016A
250008043	SULLAIR	49130A	6814910100	FREIGHTL	86704M	119144H	BLUEBIRD	86139M	1668845C1	INTERNTL	929016A
250021777	SULLAIR	49120B	6814911000	FREIGHTL	22794A	11ME229	MACK	90355A	1668846C1	INTERNTL	929016A
298517292	REX	86125M	7258000701	GROVE	89422A	11ME2293	MACK	90358A	1669749C1	INTERNTL	86548M
300043300	CARRIER	90928K	7300001050	GROVE	89763K	11ME229P4	MACK	90354A	1669751C1	INTERNTL	86548M
301815563	KOEHRING	86173M	7300001055	GROVE	89767K	11ME229P6	MACK	90368A	1669751C2	INTERNTL	86548M
303106241	AGCO	89057C	7300001068	GROVE	89766K	11ME241	MACK	89503K	1672105C91	INTERNTL	89503K
303148904	WHITE	89435E	7364002420	GROVE	89252A	11ME29	MACK	89532K	1673907C1	INTERNTL	90083A
303327701	WHITE	89440E	7406000158	GROVE	89101A	11ME299P6	MACK	90547K	1673907C3	INTERNTL	90083A
303345440	WHITE	89430E	7406000178	GROVE	89073A	1218520H91	IHC	89430E	1678071C1	INTERNTL	929011A
394202023	MC1	90366B	7406000423	GROVE	89154A	125253190M	VOLKSWAG	86190M	1678074C1	INTERNTL	929011A
394202247	UNIVCOCH	86757M	7406001091	GROVE	89082A	1280227H1	KOMATSU	89050C	1680524C1	INTERNTL	86751M
400005007	HERCULES	86191M	7406100007	GROVE	89924A	12H20	FMC	86173M	1680525C1	INTERNTL	86757M
400005018	HERCULES	86192M	7450000109	GROVE	89967K	131108C1	CASE	13900T	1688108C1	INTERNTL	929038A
409586017	FREIGHTL	90983A	7642000004	GROVE	86173M	137820R91	INTERNTL	86118M	1688109C1	INTERNTL	929038A
409833007	FREIGHTL	90984C	7642000005	GROVE	86173M	139768N000	GILLIG	86624M	1688111C1	INTERNTL	929038A
415653000	FREIGHTL	90987A	7642000009	GROVE	86168M	141527A	THOMASBB	90363A	1688662C2	INTERNTL	86531M
420121001	PIERCEGO	89028A	7642000020	GROVE	86108M	141830A	THOMASBB	90374A	16H43	FMC	86177M
420121003	PIERCEGO	89025A	7642000022	GROVE	86131M	141930A	THOMASBB	90354A	16MEA31	MACK	86514M
420121004	PIERCEGO	89026A	7642000027	GROVE	86108M	142130S	AMGENRL	90364A	16MEA31P2	MACK	86514M
420121005	PIERCEGO	89029A	7642000028	GROVE	86102M	142414R91	INTERNTL	86137M	16MEA32P4	MACK	86196M
420210003	PIERCEGO	89742K	7642000029	GROVE	86192M	142640A	THOMASBB	90376A	172691R1	INTERNTL	929003A
583986113	MACK	86113M	7642000031	GROVE	86159M	1431325H1	KOMATSU	89541K	172699R1	INTERNTL	929003A
598106550	INGERSOL	89006A	7642000052	GROVE	86190M	1431326H1	KOMATSU	89542K	17390F	OSHKOSH	86139M
700353600	TIMBERJA	86144M	7642000053	GROVE	89194U	143150A	THOMASBB	90358A	18355ZN1003	HONDA	49025N

Cross Reference by Number

OEM No.	Manuf.	Our No.	OEM No.	Manuf.	Our No.	OEM No.	Manuf.	Our No.	OEM No.	Manuf.	Our No.
18355ZN10030	HONDA	49025N	258387C1	INTERNTL	90822A	2ME367	MACK	86300M	35GZ	PACCAR	89547K
188575R91	INTERNTL	86133M	258387C2	INTERNTL	90822A	2ME371	MACK	86108M	35TS212A	PACCAR	89154A
18A2313S	FMC	86300M	25TS212A	PACCAR	89151A	2ME371P3	MACK	86149M	35VBAND	PACCAR	89512K
18A2316S	FMC	86147M	260424V11	VERSATIL	86177M	2ME372	MACK	86213M	35X30R303A	PACCAR	89274A
18A3784	FMC	86147M	260445C91	INTERNTL	86125M	2ME373	MACK	86108M	360488C1	INTERNTL	929027A
18H0419	FMC	86125M	2647998C1	INTERNTL	86631M	2ME374	MACK	86102M	3632067M1	AGCO	89967K
190981A1	CASE	90873A	265748C91	INTERNTL	86125M	2ME374P1	MACK	86102M	3632150M1	AGCO	89783A
198766A1	CASE	49130A	26685A	OSHKOSH	86133M	2ME374P2	MACK	86102M	366083C1	INTERNTL	86113M
1B17070G01	THERMOKI	89556K	277177C91	INTERNTL	86118M	2ME375	MACK	86108M	366303C1	INTERNTL	86113M
1D22101	FARMHAND	86177M	278390C91	INTERNTL	86113M	2ME376	MACK	86108M	370644R92	CASE	14245T
1G5679	CAT	89547K	27Q224	KOEHRING	86148M	2ME378	MACK	86133M	370773R91	CASE	14245T
1ME19301	MACK	86108M	27Z17	KOEHRING	86175M	2ME384	MACK	49150A	376352R91	CASE	14245T
1ME19301P029	MACK	86102M	2811005552B	BLUEBIRD	90376A	2ME391	MACK	86116M	384345R91	CASE	10156T
1ME19301P1	MACK	86108M	285203C1	INTERNTL	86135M	2ME399	MACK	86108M	384346R91	CASE	14245T
1ME19301P10	MACK	86102M	28H448	FMC	49135A	2ME49301	MACK	86131M	385203C1	INTERNTL	86667M
1ME19301P2	MACK	86102M	28N92	CAT	89168A	2ME49301P11	MACK	86130M	385307R1	CUBCADET	4790M
1ME19301P5	MACK	86108M	293994C91	INTERNTL	86667M	2ME49301P2	MACK	86130M	385308R1	CUBCADET	48111U
1ME19301P6	MACK	86131M	29424A	OSHKOSH	86300M	2ME49301P3	MACK	86195M	390226C91	INTERNTL	89503K
1ME19301P7	MACK	86108M	2ME139	MACK	86113M	2ME49301P5	MACK	86195M	393808R1	CUBCADET	14472T
1ME19301P9	MACK	86108M	2ME153	MACK	49140A	2ME49301P7	MACK	86430M	393840R91	CASE	14472T
1ME1930P7	MACK	86108M	2ME211	MACK	86127M	2MEX328	MACK	86125M	394924C2	INTERNTL	86137M
1ME1930P5	MACK	86108M	2ME211P3	MACK	86127M	2O53200	FORD	86137M	398511R1	CASE	10156T
1PS0848	CHICAGOP	86131M	2ME235	MACK	86180M	3000072C1	INTERNTL	86536M	3A01112130	KUBOTA	90914K
1PS4174	CHICAGOP	86136M	2ME236	MACK	86147M	300A1014	AP	929025A	3B6212	CAT	04849T
2004456C1	INTERNTL	90877A	2ME236P1	MACK	86195M	300A1016	TRUCKEX	89685K	3B7942	CAT	49130A
2004557C1	INTERNTL	925066A	2ME247	MACK	49150A	300A1016	AP	89685K	3B7964	CAT	49140A
200827R91	INTERNTL	86133M	2ME248	MACK	86195M	300A1414	TRUCKEX	929005A	3C	GILL	49115U
2008449C1	DINA	89450E	2ME251	MACK	86127M	300K1014	TRUCKEX	929015K	3C1P	GILL	49115U
2008955C1	INTERNTL	86774M	2ME29301P1	MACK	86130M	300K1014	AP	929015K	3E6637	CAT	89772K
200A1014	TRUCKEX	929002A	2ME29301P12	MACK	86200M	302752C91	INTERNTL	86144M	3EC03A5160	KOMATSU	90869A
200A1016	AP	929002A	2ME29301P13	MACK	86130M	30641E91	AGCO	09166T	3K3124	CAT	20153T
200A7516	AP	929002A	2ME29301P14	MACK	86130M	30645E91	AGCO	14245T	3PS4174	CHICAGOP	86115M
200K1014	AP	929013K	2ME29301P17	MACK	86195M	30647E91	AGCO	14490T	3R0682	CAT	86139M
200K1014	TRUCKEX	929013K	2ME29301P19	MACK	86195M	30654W91	AGCO	48111U	400A1014	AP	929027A
200K1016	TRUCKEX	89670K	2ME29301P20	MACK	86195M	30EL45101A	PACCAR	89073A	400A1014	TRUCKEX	929027A
200K1016	AP	89670K	2ME29301P21	MACK	86145M	30EL45200A	PACCAR	89083A	400A1016	AP	89687K
200K7016	AP	929002A	2ME29301P22	MACK	86130M	30EL90111A	PACCAR	89101A	400A1016	TRUCKEX	89687K
200K7514	AP	929002A	2ME29301P5	MACK	86200M	30EL90112A	PACCAR	89102A	400A1414	AP	929007A
200K7516	AP	929002A	2ME29301P6	MACK	86102M	30EL90212A	PACCAR	89234A	400A1414	TRUCKEX	929007A
200SP0063	GARDNER	86125M	2ME29303P7	MACK	86102M	30EL90239A	PACCAR	89090A	400C1016	AP	89674K
2013204C1	INTERNTL	925068A	2ME3101	Mack	86127M	30EL90240A	PACCAR	89091A	400C1016	TRUCKEX	89674K
2018471C1	INTERNTL	86536M	2ME3102	Mack	86514M	30FBC	PACCAR	89566K	400S1016	TRUCKEX	929035S
202000R91	INTERNTL	86133M	2ME3102	MACK	86541M	30GZ	PACCAR	89545K	4018SBELL	PACCAR	89788K
2021550C2	INTERNTL	86777M	2ME3104	MACK	86533M	30HD	PACCAR	90866A	403551R1	CASE	14245T
202SPT063	GARDNER	86180M	2ME3104P2	MACK	86430M	30STA	PACCAR	89006A	403825R1	CASE	10811T
2033675C1	INTERNTL	86631M	2ME3104P3	MACK	86196M	30STA1	PACCAR	89006A	404508R1	INTERNTL	49130A
2037707C1	INTERNTL	86775M	2ME3105	MACK	86541M	30STA120	PACCAR	89660K	4050UMB	PACCAR	89518K
2040926C1	INTERNTL	86754M	2ME3106	MACK	86542M	30TS212A	PACCAR	89153A	409828C1	INTERNTL	86108M
2041964C1	INTERNTL	86757M	2ME3106A	MACK	86542M	312137C91	INTERNTL	86118M	40CN304A	PACCAR	89162A
2041965C1	INTERNTL	86776M	2ME3112	MACK	86543M	312A1016	TRUCKEX	89686K	40CS224A	PACCAR	89043A
211618R91	INTERNTL	86139M	2ME3118	MACK	86771M	312A1016	AP	89686K	40CS224C	PACCAR	89043C
211918R91	INTERNTL	86139M	2ME3118A	MACK	86771M	312K1014	AP	929026A	40CS236A	PACCAR	89044A
212A1014	AP	929004A	2ME3119	Mack	86526M	315120C91	INTERNTL	86115M	40CS248A	PACCAR	89045A
212A1014	TRUCKEX	929004A	2ME3135	Mack	86531M	3235459R1	INTERNTL	86115M	40EL45103A	PACCAR	89780A
212A1016	AP	929004A	2ME314	MACK	86139M	324937C1	INTERNTL	86153M	40EL45104A	PACCAR	89074A
212K1014	AP	929014K	2ME314BP3	MACK	86139M	324937C91	INTERNTL	86153M	40EL45203A	PACCAR	89782A
212K1014	TRUCKEX	929014K	2ME335	MACK	86127M	32H511	FMC	86203M	40EL45204A	PACCAR	89084A
212K7514	AP	929004A	2ME335	BROCKWAY	86127M	333476C91	INTERNTL	86145M	40EL70270A	PACCAR	89238A
21396P	SMITHCO	48210U	2ME335AP2	MACK	86153M	338614C1	INTERNTL	89512K	40EL90116A	PACCAR	89105A
214463R91	INTERNTL	86133M	2ME335AP3	MACK	86127M	343458C91	INTERNTL	86135M	40EL90117A	PACCAR	89106A
214A1014	AP	929003A	2ME335P1	MACK	86125M	343459C91	INTERNTL	86667M	40EL90217A	PACCAR	89115A
214A1014	TRUCKEX	929003A	2ME336	MACK	86127M	350601R95	CASE	14245T	40EL90219A	PACCAR	89116A
214A7514	AP	929003A	2ME336B	MACK	86127M	3511319C1	INTERNTL	86776M	40EL90242A	PACCAR	89094A
214K1014	AP	929003A	2ME337A	MACK	86106M	3511320C1	INTERNTL	86531M	40EL90243A	PACCAR	89095A
214K1016	TRUCKEX	89697K	2ME337AP3	MACK	86153M	351436R92	CASE	16487T	40FA475	PACCAR	90575A
214K7014	AP	929003A	2ME337P1	MACK	86106M	351436R92	CUBCADET	16487T	40FBC	PACCAR	89568K
214K7514	AP	929003A	2ME337P2	MACK	86106M	3521583C1	INTERNTL	925070A	40FBZ	PACCAR	89558K
234658R91	INTERNTL	86164M	2ME337P3	MACK	86153M	3521589C1	INTERNTL	925071A	40FC	PACCAR	89965K
234A1014	AP	929024A	2ME338	BROCKWAY	86127M	356153C1	INTERNTL	86145M	40GZ	PACCAR	89548K
234A1014	TRUCKEX	929024A	2ME338	MACK	86127M	357288R92	CASE	14245T	40HD	PACCAR	90867A
234A1016	AP	929024A	2ME339	MACK	86108M	357875A1	CASE	90877A	40STA120	PACCAR	89661K
234A1414	AP	929005A	2ME347	MACK	86127M	358921C1	INTERNTL	86153M	40TA	PACCAR	89940A
234A1414	TRUCKEX	929005A	2ME349	MACK	86132M	359696A1	CASE	90875A	40TS118A	PACCAR	89145A
234C1016	AP	90615K	2ME355	MACK	86127M	35E690241A	PACCAR	89093A	40TS118C	PACCAR	89145C
234C1016	TRUCKEX	90615K	2ME355A	MACK	86127M	35EL45102A	PACCAR	89077A	40TS218A	PACCAR	89155A
240683R91	INTERNTL	86667M	2ME356	MACK	86135M	35EL45202A	PACCAR	89087A	40TS218C	PACCAR	89155C
242148R91	INTERNTL	86137M	2ME357	MACK	86131M	35EL90114A	PACCAR	89103A	40TX218C	PACCAR	89155C
244007R91	INTERNTL	86139M	2ME361P4	MACK	27961A	35EL90115A	PACCAR	89104A	40VBAND	PACCAR	89513K
244007R91	INTERNTL	86139M	2ME361P5	MACK	86149M	35EL90214A	PACCAR	89235A	40X30R403A	PACCAR	89185A
246017R91	INTERNTL	86115M	2ME363P5	MACK	23328A	35EL90215A	PACCAR	89114A	40X35R404A	PACCAR	89186A
256017C91	INTERNTL	86151M	2ME366	MACK	86132M	35EL90241A	PACCAR	89093A	412A1016	TRUCKEX	89678K

Cross Reference by Number

OEM No.	Manuf.	Our No.	OEM No.	Manuf.	Our No.	OEM No.	Manuf.	Our No.	OEM No.	Manuf.	Our No.
413363A1		CASE 90366B	482614C2	INTERNTL	929016A	50TS218C	PACCAR	89146C	583986740M	MACK	86740M
418705C1	INTERNTL	86144M	482616C1	INTERNTL	929011A	50VBAND	PACCAR	89503K	583986771M	MACK	86771M
420V4361	KOEHRING	86168M	482618C1	INTERNTL	929011A	50X40R405A	PACCAR	89187A	583989014A	MACK	89014A
420V4382	KOEHRING	86159M	482620C1	INTERNTL	929011A	511343C1	INTERNTL	929007A	583989019A	MACK	89019A
420V4387	KOEHRING	86106M	482622C1	INTERNTL	929011A	511343C1	INTERNTL	929007A	583989019C	MACK	89019C
420V4388	KOEHRING	86102M	482624C1	INTERNTL	929011A	5127819X0121	GMC	89797K	583989025A	MACK	89025A
420V4390	KOEHRING	86213M	482626C1	INTERNTL	929011A	512A1016	TRUCKEX	89679K	583989045C	MACK	89045C
424858C1	INTERNTL	86108M	483005C1	INTERNTL	86667M	519517C3	INTERNTL	929007A	583989046A	MACK	89046A
42502A2130	KOMATSU	90358B	483005C2	INTERNTL	86135M	520541C1	INTERNTL	86153M	583989046C	MACK	89046C
42502A2130	KOMATSU	90358B	484253C1	INTERNTL	86185M	523719C3	INTERNTL	86544M	583989047A	MACK	89047A
425137C1	INTERNTL	86132M	484476C2	INTERNTL	86570M	523962C1	INTERNTL	89196U	583989049A	MACK	89049A
425507C1	INTERNTL	86108M	484885C1	INTERNTL	86669M	524605C1	INTERNTL	86300M	583989056C	MACK	89056C
425624R91	INTERNTL	89505K	485934C1	INTERNTL	86130M	525193M1	MASSEY	86135M	583989057C	MACK	89057C
425937C1	INTERNTL	86132M	486089C1	INTERNTL	86195M	525VBAND	PACCAR	90531K	583989074A	MACK	89074A
426428C91	INTERNTL	86512M	486109C91	INTERNTL	86130M	530578R4	CASE	11650T	583989074C	MACK	89074C
429619C1	INTERNTL	86113M	486110C1	INTERNTL	86130M	530588R4	CASE	11651T	583989075A	MACK	89075A
431256C1	INTERNTL	86108M	488064C2	INTERNTL	86102M	531815R1	INTERNTL	49125A	583989075C	MACK	89075C
431517R91	INTERNTL	86108M	488710C1	INTERNTL	86184M	532347C91	INTERNTL	86108M	583989090A	MACK	89090A
433192R91	INTERNTL	89507K	488710C2	INTERNTL	86184M	532383C1	INTERNTL	90962A	583989094A	MACK	89094A
434252R91	INTERNTL	89506K	489890C2	INTERNTL	86570M	532395C1	INTERNTL	89893A	583989095A	MACK	89095A
434507C91	INTERNTL	86108M	48RU2341	MACK	89533K	53258B	OSHKOSH	86102M	583989096A	MACK	89096A
434836C1	INTERNTL	86108M	495351C2	INTERNTL	86130M	5333396000N	GILLIG	86125M	583989097A	MACK	89097A
434847C1	INTERNTL	86102M	499388C1	INTERNTL	89880A	534545R4	CASE	11731T	583989102A	MACK	89102A
436198C1	INTERNTL	86113M	499421C1	INTERNTL	86533M	534546R6	CASE	17704T	583989103A	MACK	89103A
437790C1	INTERNTL	86669M	499495C1	INTERNTL	86200M	548287C1	INTERNTL	86195M	583989105A	MACK	89105A
439248R91	INTERNTL	86133M	499528C1	INTERNTL	86139M	548804C1	INTERNTL	86511M	583989105C	MACK	89105C
439797C1	INTERNTL	86151M	499528C1	INTERNTL	86139M	54906B	OSHKOSH	86131M	583989106A	MACK	89106A
440377C1	INTERNTL	86151M	4999421C1	INTERNTL	86533M	549464C1	INTERNTL	86136M	583989107A	MACK	89107A
440378C1	INTERNTL	86151M	4ME21698	MACK	89897A	549465C1	INTERNTL	86137M	583989107C	MACK	89107C
442927C1	INTERNTL	86108M	4ME32603	MACK	90922A	549466C1	INTERNTL	86164M	583989108A	MACK	89108A
442928C1	INTERNTL	86102M	4ME32612	MACK	89887A	549469C1	INTERNTL	86139M	583989115A	MACK	89115A
442930C1	INTERNTL	86108M	4PS4174	CHICAGOP	86125M	549483C1	INTERNTL	86200M	583989115C	MACK	89115C
447124C1	INTERNTL	86113M	500872C1	INTERNTL	86195M	549485C1	INTERNTL	86305M	583989116A	MACK	89116A
447125C1	INTERNTL	86113M	500A1016	AP	89688K	549559C91	INTERNTL	89528K	583989117A	MACK	89117A
447803A	VOLVO	86147M	500A1016	TRUCKEX	89688K	549563C91	INTERNTL	89521K	583989117C	MACK	89117C
4507036R1	INTERNTL	49160A	500C1016	AP	89675K	55183G	OSHKOSH	86300M	583989123A	MACK	89123A
453180C1	INTERNTL	86145M	500C1016	TRUCKEX	89675K	556687C1	INTERNTL	86102M	583989126A	MACK	89126A
454306R91	INTERNTL	86108M	500S1016	TRUCKEX	929036S	572479C1	INTERNTL	86184M	583989145A	MACK	89145A
454308C91	INTERNTL	86102M	501462C1	INTERNTL	86102M	577265C1	INTERNTL	929011A	583989145C	MACK	89145C
45A0154X	FMC	86106M	501463C1	INTERNTL	86533M	577806C1	INTERNTL	86185M	583989146A	MACK	89146A
45A1238	FMC	86148M	501464C1	INTERNTL	86130M	578068C1	INTERNTL	86185M	583989146C	MACK	89146C
4608517H1	KOMATSU	89020A	5016230M1	AGCO	90876A	578070C1	INTERNTL	86513M	583989155A	MACK	89155A
4608518H1	KOMATSU	89430E	5016231M1	AGCO	89548K	578090M92	AGCO	14222T	583989161A	MACK	89161A
4608518H1	KOMATSU	89430E	5016231M2	AGCO	89527K	578090M92	MASSEY	14222T	583989162A	MACK	89162A
462513C91	INTERNTL	86108M	5018SBELL	PACCAR	89789K	580194C1	INTERNTL	86135M	583989166A	MACK	89166A
463026C1	INTERNTL	86108M	503377C1	INTERNTL	86108M	58162HA	INTERNTL	86136M	583989167A	MACK	89167A
463765C1	INTERNTL	86159M	504886C1	INTERNTL	86130M	582122C1	INTERNTL	86514M	583989173A	MACK	89173A
464643C1	INTERNTL	86139M	504926C1	INTERNTL	86185M	582167C1	INTERNTL	90823A	583989187A	MACK	89187C
464643C1	INTERNTL	86139M	504926C1	INTERNTL	86185M	583927961A	MACK	27961A	583989196U	MACK	89196U
465971C1	INTERNTL	86139M	505620S3	PACCAR	89744C	583949150A	MACK	49150A	583989198U	MACK	89198U
465971C1	INTERNTL	86139M	508797C91	INTERNTL	89527W	583967C91	INTERNTL	90374A	583989256A	MACK	89256A
465971C91	INTERNTL	86139M	508798C91	INTERNTL	89528W	583968C91	INTERNTL	90375A	583989276A	MACK	89276A
465984C1	INTERNTL	86139M	508804C1	INTERNTL	86511M	583969C91	INTERNTL	90376A	583989277A	MACK	89277A
465984C1	INTERNTL	86139M	50CS1108C	PACCAR	90526C	583970C91	INTERNTL	90378A	583989435A	MACK	89435E
466817C1	INTERNTL	86159M	50CS1120C	PACCAR	90614C	583971C91	INTERNTL	90379A	583989435A	MACK	89435E
466894C1	INTERNTL	86139M	50CS2108C	PACCAR	928011C	583973C91	INTERNTL	90352A	583989440A	MACK	89440E
466984C91	INTERNTL	86139M	50CS218A	PACCAR	89156A	583974C91	INTERNTL	90353A	583989440A	MACK	89440E
466984C91	INTERNTL	86139M	50CS296C	PACCAR	89298C	583975C91	INTERNTL	90354A	583989440C	MACK	89440C
467614C1	INTERNTL	86159M	50DTS51A	PACCAR	90452A	583977C91	INTERNTL	90355A	583989440C	MACK	89440E
468720C1	INTERNTL	86597M	50DTS51C	PACCAR	90452C	583979C91	INTERNTL	90358A	583989450A	MACK	89450E
469801C1	INTERNTL	86102M	50EL15260A	PACCAR	89133A	583979C91	INTERNTL	90358A	583989450A	MACK	89450E
470263M91	MASSEY	49130A	50EL45106A	PACCAR	89075A	583980C91	INTERNTL	90546K	583989450C	MACK	89450E
471382C1	INTERNTL	86139M	50EL45106C	PACCAR	89075C	583981C91	INTERNTL	90547K	583989450C	MACK	89450E
471382C2	INTERNTL	86139M	50EL70270A	PACCAR	89239A	583986102M	MACK	86102M	583989503K	MACK	89503K
471382C91	INTERNTL	86139M	50EL90121A	PACCAR	89108A	583986108M	MACK	86108M	583989513K	MACK	89513K
471382C91	INTERNTL	86139M	50EL90123A	PACCAR	89784A	583986113M	MACK	86113M	583989514K	MACK	89514K
475306C2	INTERNTL	89892A	50FA55	PACCAR	90569A	583986127M	MACK	86127M	583989527K	MACK	89527K
475354C1	INTERNTL	86195M	50FBC	PACCAR	89569K	583986130M	MACK	86130M	583989528K	MACK	89528K
475674C1	INTERNTL	89193U	50FBZ	PACCAR	89559B	583986131M	MACK	86131M	583989533K	MACK	89533K
477662C1	INTERNTL	90958A	50FBZ	PACCAR	89559B	583986132M	MACK	86132M	583989543K	MACK	89543K
47786B	OSHKOSH	86108M	50FC	PACCAR	89966K	583986145M	MACK	86145M	583989545K	MACK	89545K
47786BX	OSHKOSH	86108M	50FCTURBO	PACCAR	89967K	583986153M	MACK	86153M	583989547K	MACK	89547K
479929C3	INTERNTL	86598M	50GZ	PACCAR	89549K	583986514M	MACK	86514M	583989548K	MACK	89548K
47A0978	FMC	86193M	50HD	PACCAR	90868A	583986533M	MACK	86533M	583989549C	MACK	89549C
481445C2	INTERNTL	86511M	50MS1108C	PACCAR	90597C	583986536M	MACK	86536M	583989549K	MACK	89549K
481727C2	INTERNTL	86510M	50MS296C	PACCAR	90591C	583986545M	MACK	86545M	583989558K	MACK	89558K
482167C1	INTERNTL	86512M	50SG2053	PACCAR	89744C	583986682M	MACK	86682M	583989559K	MACK	89559K
482167C1	INTERNTL	86512M	50STA120	PACCAR	89662K	583986700M	MACK	86700M	583989559K	MACK	89559K
482168C1	INTERNTL	926005A	50TCCID	PACCAR	90534A	583986712M	MACK	86712M	583989569K	MACK	89569K
482174C1	INTERNTL	926062A	50TCCOD	PACCAR	90533A	583986713M	MACK	86713M	583989571K	MACK	89571K
482612C2	INTERNTL	929016A	50TS118A	PACCAR	89146A	583986739M	MACK	86739M	583989606K	MACK	89606K

Cross Reference by Number

OEM No.	Manuf.	Our No.	OEM No.	Manuf.	Our No.	OEM No.	Manuf.	Our No.	OEM No.	Manuf.	Our No.
583989607K	MACK	89607K	591595C92	INTERNTL	926008A	7GB010	AUTOCAR	86108M	979541R91	INTERNTL	86108M
583989608K	MACK	89608K	5932836C	AMGENRL	90358A	7GB010	WHITE	86108M	985125R91	INTERNTL	86131M
583989609K	MACK	89609K	5932837C	AMGENRL	90378A	7HC5230D	FORD	86136M	985721R91	INTERNTL	86131M
583989611K	MACK	89611K	593782C91	INTERNTL	926008A	7LT400	RIKER	86144M	987177R91	INTERNTL	86127M
583989624K	MACK	89624K	593782C92	INTERNTL	926008A	7S8443	CAT	20620T	989288R91	INTERNTL	86132M
583989625K	MACK	89625K	593783C1	INTERNTL	924023A	80000FT6	OSHKOSH	89626K	989443R91	INTERNTL	86125M
583989644K	MACK	89644K	593783C11	INTERNTL	926008A	816782A	VOLVO	86189M	992L1	DIAMONDR	86108M
583989645K	MACK	89645K	598474C1	INTERNTL	86102M	816782A	WHITE	86189M	992L11	DIAMONDR	86102M
583989674K	MACK	89674K	59A2074	FMC	86148M	8175C42G01	PACCAR	89559B	992L12	DIAMONDR	86108M
583989675K	MACK	89675K	5C20B	GILL	49120B	829176C91	CASE	14099T	995124R91	INTERNTL	86131M
583989686K	MACK	89686K	5CV20	GILL	49120B	829640C91	CASE	13994T	998025C1	INTERNTL	86127M
583989687K	MACK	89687K	5CV24	GILL	49125A	829640C92	CASE	13994T	9F6433	CAT	86125M
583989688K	MACK	89688K	5PP00001A	PAYHAULE	89046A	84B10351	MILLEREL	89090A	9H47	FMC	86125M
583989713K	MACK	89713K	5PP00002A	PAYHAULE	89047A	84B10352	MILLEREL	89092A	9H554	FMC	86213M
583989714K	MACK	89714K	5PS4174	CHICAGOP	86147M	84B10441	MILLEREL	89087A	9LT400	RIKER	86144M
583989715K	MACK	89715K	6005G	OSHKOSH	86125M	850485B	AUTOCAR	86127M	9LT500	RIKER	86145M
583989723K	MACK	89723K	600A1016	AP	89698K	858630L2	DIAMONDR	86144M	9N8199	CAT	89168A
583989724K	MACK	89724K	600A1016	TRUCKEX	89698K	858791L1	DIAMONDR	86144M	9S9328	CAT	20619T
583989727K	MACK	89727K	600C1016	AP	89676K	86132M	PACCAR	86132M	9XD352	RIKER	86113M
583989728K	MACK	89728K	6018SBELL	PACCAR	89790K	86305M	PACCAR	86305M	9XD356	RIKER	86113M
583989729K	MACK	89729K	606T122	VERSATIL	86178M	86502M	PACCAR	86502M	9XD400	RIKER	86131M
583989730K	MACK	89730K	606T123A	INTERNTL	86135M	865034C91	INTERNTL	86133M	9XD401	RIKER	86131M
583989731K	MACK	89731K	606T123A	VERSATIL	86135M	86505M	PACCAR	86505M	9XD402	RIKER	86131M
583989733K	MACK	89733K	60FBFC	PACCAR	89570K	86624M	PACCAR	86624M	9XD403	RIKER	86108M
583989744K	MACK	89744K	60FBZ	PACCAR	89560B	86664M	PACCAR	86664M	9XD404	RIKER	86131M
583989749K	MACK	89749K	60GZ	PACCAR	89550K	868431R91	INTERNTL	86115M	9XD405	RIKER	86131M
583989759K	MACK	89759K	60SG20S3	PACCAR	90856C	870876C91	INTERNTL	86133M	9XD406	RIKER	86108M
583989763K	MACK	89763K	60STA	PACCAR	89698K	870876R91	INTERNTL	86133M	9XD500	RIKER	86132M
583989766K	MACK	89766K	60STA120	PACCAR	89698K	871834R91	INTERNTL	86108M	9XD501	RIKER	86132M
583989767K	MACK	89767K	60X50CS1108C	PACCAR	90450C	880L1	DIAMONDR	86132M	9XD502	RIKER	86132M
583989771K	MACK	89771K	60X50CS1120C	PACCAR	90579C	889L1	DIAMONDR	86127M	9XD503	RIKER	86132M
583989772K	MACK	89772K	60X50CS148C	PACCAR	924072C	88H400148	DYNAFLEX	86148M	9XD505	RIKER	86102M
583989780A	MACK	89780A	60X50CS160C	PACCAR	90905C	89107A	PACCAR	89107A	9XD506	RIKER	86102M
583989781C	MACK	89781C	60X50CS172C	PACCAR	90447C	893944R92	INTERNTL	89501K	9XD508	RIKER	86102M
583989782A	MACK	89782A	60X50CS184C	PACCAR	90448C	893945R92	INTERNTL	89520K	A0410342	FREIGHTL	86102M
583989783A	MACK	89783A	60X50CS196C	PACCAR	90449C	89548C	PACCAR	89548C	A0410342000	FREIGHTL	86102M
583989784A	MACK	89784A	60X50CS248C	PACCAR	90568C	89549C	PACCAR	89549C	A0410562	FREIGHTL	86108M
583989784C	MACK	89784C	60X50CS260C	PACCAR	90570C	89549K	PACCAR	89549K	A0410617	FREIGHTL	86108M
583989897A	MACK	89897A	60X50CS272C	PACCAR	90571C	89619K	PACCAR	89619K	A0410618	FREIGHTL	86108M
583989899A	MACK	89899A	60X50MS1108C	PACCAR	90577C	844282	FMC	86131M	A0410879	FREIGHTL	86102M
583989923A	MACK	89923C	60X50MS1120C	PACCAR	90578C	8A5098	CRANECAR	86139M	A0411447	FREIGHTL	86200M
583989923A	MACK	89923C	60X50MS148C	PACCAR	900035C	8A5566A	FMC	49140A	A0411694	FREIGHTL	86130M
583989924A	MACK	89924A	60X50MS196C	PACCAR	90576C	8A5810	FMC	86203M	A0411717	FREIGHTL	86195M
583989940A	MACK	89940C	60X50MS260C	PACCAR	900094C	8C2246	CAT	89059A	A04117171	FREIGHTL	86195M
583989950A	MACK	89950C	619077A	AUTOCAR	86135M	8CV34	GILL	49135A	A0411840	FREIGHTL	86130M
583989950A	MACK	89950C	621483A	AUTOCAR	86135M	8CV40	GILL	49140A	A0411843	FREIGHTL	86130M
583989965K	MACK	89965K	623L1	DIAMONDR	86131M	8CV50	GILL	49150A	A0412094	FREIGHTL	86130M
583989966K	MACK	89966K	62W6483	FMC	89144A	8CV60	GILL	49160A	A0412096000	FREIGHTL	90358A
583989967K	MACK	89967K	64RT500138	CARRIER	89541K	8G191	MCI	90365B	A0412096004	FREIGHTL	90365A
583989985C	MACK	89985C	64RT500153	CARRIER	89519K	8L20101	MOTORCO	89503K	A0412270	FREIGHTL	86195M
583989986C	MACK	89986C	65X120CF	PACCAR	90579C	8L2072	MOTORCO	89520K	A0412556	FREIGHTL	86130M
583989987C	MACK	89987C	689400R91	INTERNTL	86131M	8LT400	RIKER	86144M	A0412966	FREIGHTL	86130M
583989988C	MACK	89988C	690420R91	INTERNTL	86125M	8S2809	CAT	20154T	A0412967	WHITE	86130M
583989989C	MACK	89989C	69427B	OSHKOSH	86195M	90442C	PACCAR	90442C	A0412967	FREIGHTL	86130M
583989993C	MACK	89993C	694848R91	INTERNTL	86131M	907636T1	CASE	90358C	A0413975	FREIGHTL	86531M
583990358A	MACK	90358B	69941B	OSHKOSH	86130M	907636T1	CASE	90358C	A0414075	FREIGHTL	86531M
583990358A	MACK	90358B	69941BX	OSHKOSH	86130M	90MG10S4	PACCAR	90461C	A049981	FREIGHTL	86108M
583990368A	MACK	90368B	6C24	GILL	49125A	90MG20S4	PACCAR	89749C	A049982	FREIGHTL	86108M
583990368A	MACK	90368B	6C30	GILL	49130A	90MG30S4	PACCAR	89774C	A049984	FREIGHTL	86108M
583990386A	MACK	90386B	6C34	GILL	49135A	90MG31S3	PACCAR	89745C	A049990	FREIGHTL	86102M
583990386A	MACK	90386B	6CV24	GILL	49125A	90MG40S4	PACCAR	89995C	A049995	FREIGHTL	86102M
583990448C	MACK	90448C	6CV30	GILL	49130A	90MG41S3	PACCAR	89996C	A049996	FREIGHTL	86102M
583990449C	MACK	90449C	6CV34	GILL	49135A	90UH1	PACCAR	89539K	A062880	CASE	89547K
583990451A	MACK	90451A	6PS4174	CHICAGOP	86102M	9130B3019017	ENTWISTL	90892K	A139471	CASE	14663T
583990451C	MACK	90451C	700768L2	DIAMONDR	49140A	9175C42G01	THERMOKI	89559K	A142751	CASE	22705T
583990452A	MACK	90452A	717954A	VOLVO	86187M	9197C92G01	THERMOKI	89559B	A147044	CASE	22152T
583990452C	MACK	90452C	72095R91	INTERNTL	86137M	9310B3019005	ENTWISTL	89440E	A147100	CASE	15572T
583990598C	MACK	90598C	75152C91	IHC	86562M	9310B3019007	ENTWISTL	89923C	A15163	CASE	22706T
583990847C	MACK	90847C	753980C91	INTERNTL	86102M	9310B3019011	ENTWISTL	89674K	A172152	CASE	042088
583990854A	MACK	90854A	762683C91	INTERNTL	86118M	9310B3020015	ENTWISTL	89671K	A172785	CASE	20332A
583990859C	MACK	90859C	762782C91	INTERNTL	86147M	9310B3020017	ENTWISTL	89672K	A173180	CASE	20680T
583990902K	MACK	90902K	762783C91	INTERNTL	86118M	9310C3105001	ENTWISTL	89430E	A180204	CASE	042089
583990903K	MACK	90903K	763196C91	INTERNTL	86132M	9314A094170	ENTWISTL	89673K	A184157	CASE	21326A
584173C1	INTERNTL	86514M	76685A	OSHKOSH	86133M	9314C094105	ENTWISTL	89430E	A189374	CASE	89430E
586606C1	INTERNTL	86130M	780067C91	INTERNTL	89510K	931SA0393	CLARK	86125M	A19563	CASE	86173M
587519C2	INTERNTL	90966A	783788C1	INTERNTL	86300M	931SA185	CLARK	86125M	A21464	CASE	86178M
587521C2	INTERNTL	90967A	789843C1	INTERNTL	86300M	9315B0393	CLARK	86145M	A215675	JOY	86125M
5893990847C	MACK	90847A	795570C1	INTERNTL	86147M	958116487T	FORD	16487T	A23118051	PETTIBON	86131M
5904062C1	INTERNTL	86514M	7AA452A	OLIVER	14245T	97428R91	INTERNTL	86113M	A2318028	PETTIBON	86139M
591593C91	INTERNTL	925014A	7AN010	AUTOCAR	86127M	976488R91	INTERNTL	86125M	A23476	CASE	86178M
591595C91	INTERNTL	926008A	7EQ5230	FORD	86137M	979491R91	INTERNTL	86131M	A24314	CASE	86178M

Cross Reference by Number

OEM No.	Manuf.	Our No.	OEM No.	Manuf.	Our No.	OEM No.	Manuf.	Our No.	OEM No.	Manuf.	Our No.
A300	AP	89525W	C2TA5230A	FORD	86133M	D4TZ5230L	FORD	86164M	DX3590826	HENDRICK	86108M
A30060PL	RIKER	925051C	C2TZ5230A	FORD	86133M	D5HA5225HA	FORD	86200M	DX3590834	HENDRICK	86200M
A312	AP	89526W	C3TA5230S	FORD	86108M	D5HZ5230G	FORD	86200M	DX3590837	HENDRICK	86195M
A39022	CASE	11396T	C3TZ5230A	FORD	86136M	D5TA5225BDA	FORD	86669M	DX3590842	HENDRICK	86130M
A39561	CASE	11669T	C3TZ5230B	FORD	86137M	D5TA5225BDA1	FORD	86213M	DX3590844	HENDRICK	86200M
A400	AP	89527W	C3TZ5230B	FORD	86137M	D5TA5225DBA1	FORD	86512M	DX3590856	HENDRICK	86195M
A40801	DAVEY	86175M	C3TZ5230B	FORD	86137M	D5TA5225DBA1	FORD	86512M	DX3590899	HENDRICK	86108M
A42229	CASE	49125A	C3TZ5230D	FORD	86136M	D5TZ5230AC	FORD	86137M	EOHT5225CA	FORD	86153M
A4957	CRANECAR	86139M	C3TZ5230E	FORD	86136M	D5TZ5230AH	FORD	86213M	EOHT5225EB	FORD	86200M
A500	AP	89528W	C3TZ5230F	FORD	86108M	D5TZ5230AH	FORD	86213M	EOHT5225LA	FORD	86503M
A56029	CASE	86150M	C3TZ5230G	FORD	86136M	D5TZ5230CL	FORD	86164M	EOHT5225MA	FORD	86213M
A60048PL	RIKER	89224C	C4TS5230A	FORD	86139M	D5TZ5230J	FORD	86137M	EOHT5230CA	FORD	86130M
A600PL	RIKER	89147C	C4TZ5230B	FORD	86139M	D5TZ5255AK	FORD	929026A	EOHZ5263A	FORD	929005A
A64990	CASE	11026T	C5TS5230A	FORD	86200M	D5VZ5230AF	FORD	86675M	EOHZ5263D	FORD	929005A
A66780	CASE	22150T	C5TZ5230A	FORD	86136M	D5VZ5230AZ	FORD	86675M	EOHZ5263E	FORD	929005A
AA30060PL	RIKER	900088C	C5TZ5230C	FORD	86136M	D5VZ5230G	FORD	86675M	EOHZ5263F	FORD	929005A
AA33992	HENDRICK	86108M	C5TZ5230D	FORD	86136M	D64008	CASE	13909T	EOHZ5263G	FORD	929007A
AE20601	JDEERE	86139M	C6H0239	LINKBELT	89923C	D645239	GALION	86173M	EOHZ5A231C	FORD	89509K
AH11054H	JDEERE	86178M	C6TZ5230A	FORD	86125M	D6HS5230AA	FORD	86200M	EONN5A281AA	FORD	90355A
AH6019	FMC	86213M	C6TZ5230AH	FORD	86108M	D6HS5230DA	FORD	86145M	EONN5A281BA	FORD	90363A
AM115838	JDEERE	49025N	C6TZ5230D	FORD	86136M	D6NN5252C	NEWHOLLA	900040K	E1HT5225DA	FORD	86672M
AN203989	JDEERE	89505K	C6TZ5230F	FORD	86131M	D71668	LORAIN	86139M	E1HT5225FA	FORD	86430M
AN273958	JDEERE	89559B	C6TZ5230G	FORD	86136M	D7HT5225AJA	FORD	86200M	E1HT5225JA	FORD	86130M
AP33334	JDEERE	90870A	C6TZ5230H	FORD	86136M	D7HT5225BTA	FORD	86213M	E1HT5270AA	FORD	90368A
AR86603	JDEERE	89440E	C6UZ5230C	FORD	86136M	D7HT5225BTA	FORD	86195M	E1HT5270BA	FORD	90358A
AS300	AP	90873A	C7TZ5230A	FORD	86168M	D7HT5225BNA	FORD	86203M	E1HT5270CA	FORD	90363A
AS350	AP	90874A	C7TZ5230D	FORD	86136M	D7HT5225BTA	FORD	86213M	E1HT5270EA	FORD	90355A
AS400	AP	90875A	C7TZ5230E	FORD	86136M	D7HT5225BTA	FORD	86213M	E1HT5270GA	FORD	90547K
AS400	TRUCKEX	90875A	C7TZ5230F	FORD	86137M	D7HT5225BTA	FORD	86213M	E1HT5270HA	FORD	90352A
AS500	AP	90877A	C7TZ5230H	FORD	86137M	D7HT5225CLA	FORD	86130M	E1HZ5230D	FORD	86430M
AS500	TRUCKEX	90877A	C7TZ5230J	FORD	86137M	D7HT5230BEA	FORD	86130M	E1HZ5A231A	FORD	90363A
AT10646	JDEERE	86177M	C7TZ5230K	FORD	86136M	D7HT5230FRA	FORD	86130M	E1HZ5A231B	FORD	90368A
AT128887	JDEERE	89525K	C7TZ5230M	FORD	86137M	D7HT5230FYA	FORD	86195M	E1HZ5A231D	FORD	90358A
AT175376	JDEERE	89548K	C8HS5230A	FORD	86685M	D7HT5230GEA	FORD	86130M	E1HZ5A231E	FORD	90352A
AT180264	JDEERE	89558B	C8HS5230B	FORD	86685M	D8HS5225CA	FORD	86200M	E1HZ5A231F	FORD	90547K
AT650110	HENDRICK	86144M	C8HS5230G	FORD	86147M	D8HS5225EA	FORD	86195M	E1HZ5A231G	FORD	90355A
AT650111	HENDRICK	49160A	C8HS5230H	FORD	86132M	D8HT5230BA	FORD	86130M	E1TZ5230G	FORD	86675M
AW26849	JDEERE	49020N	C8HZ5230C	FORD	86153M	D8HT5230CA	FORD	86130M	E2HT5225AFB	FORD	86650M
AY2582	ELGNSWPR	86139M	C8TZ5230B	FORD	86137M	D8HX5246M	FORD	90938A	E2HT5225AG2A	FORD	86502M
AZ44000223	MCI	90358B	C8TZ5230C	FORD	86153M	D8HZ5230AB	FORD	86195M	E2HT5225AGA	FORD	86502M
B126367	LORAIN	86102M	C8UZ5230B	FORD	86136M	D8HZ5230AC	FORD	86669M	E2HT5225ABZ	FORD	86503M
B126705	LORAIN	86106M	C9HA5225A	FORD	86173M	D8HZ5230AE	FORD	86215M	E2HT5225BCA	FORD	86130M
B200	AP	89521K	C9TZ5230A	FORD	86136M	D8HZ5230AF	FORD	86130M	E2HT5225BE2A	FORD	86501M
B200	TRUCKEX	89521K	CH802F	BILNGSLY	925002A	D8HZ5230AT	FORD	86130M	E2HT5225BEA	FORD	86501M
B212	AP	89523K	CH802G	BILNGSLY	929012A	D8HZ5230AV	FORD	86195M	E2HT5225BFA	FORD	86195M
B212	TRUCKEX	89523K	CL1352	WABCO	86173M	D8HZ5230B	FORD	86130M	E2HT5225BGA	FORD	86130M
B214	AP	89522K	CLV400	TRUCKEX	90907K	D8HZ5230F	FORD	86130M	E2HT5225BHA	FORD	86200M
B214	TRUCKEX	89522K	CMS00133	CUMMINS	Q186112	D8HZ5246M	FORD	90938A	E2HT5225BKCA	FORD	86195M
B234	AP	89524K	CRT2063	JOHN MAT	89450E	D8HZ5246M	FORD	90938A	E2HT5225BLA	FORD	86130M
B300	TRUCKEX	89525K	D0HA5225AE	FORD	86115M	D8NN5252AA	NEWHOLLA	900041K	E2HT5225BMA	FORD	86130M
B300	AP	89525K	D0HA5225L	FORD	86213M	D8TZ5230AC	FORD	86152M	E2HT5225BNA	FORD	86503M
B312	TRUCKEX	89526K	D0HA5230J	FORD	86108M	D8TZ5230C	FORD	86675M	E2HT5225FA	FORD	86221M
B312	AP	89526K	D0HT5225CLA	FORD	86130M	D8TZ5230CF	FORD	86137M	E2HT5225KB	FORD	86220M
B400	TRUCKEX	89527K	D0HZ5230J	FORD	86213M	D8TZ5230D	FORD	86675M	E2HT5225L	FORD	86130M
B400	AP	89527K	D0HZ5230J	FORD	86213M	D8TZ5230E	FORD	86675M	E2HT5225SB	FORD	86200M
B412	TRUCKEX	90464K	D0HZ5230L	FORD	86102M	D8TZ5230W	FORD	86675M	E2HT5230ANA	FORD	86183M
B500	TRUCKEX	89528K	D0HZ5230M	FORD	86113M	D8TZ5230Y	FORD	86675M	E2HT5230BA	FORD	86184M
B500	AP	89528K	D0HZ5230M	FORD	86115M	D9HS5225JA	FORD	86200M	E2HZ5230L	FORD	86130M
B500V	GOERLICH	900273A	D0HZ5230R	FORD	86125M	D9HT51210DA	FORD	89530K	E2HZ5230N	FORD	86220M
B5T5230A	FORD	86137M	D100312	GALION	86175M	D9HZ5230A	FORD	86183M	E2HZ5230R	FORD	86183M
B600	AP	89529K	D101877	GALION	86168M	D9HZ5230A	FORD	86183M	E2HZ5230S	FORD	86183M
B600	TRUCKEX	89529K	D114338	GALION	86139M	D9HZ5230B	FORD	86183M	E2HZ5230S	FORD	86183M
B7C5230A	FORD	86136M	D117248	GALION	86106M	D9HZ5230B	FORD	86183M	E2HZ5230Y	FORD	86544M
B7Q5230A	FORD	86137M	D126170	GALION	86137M	D9HZ5263G	FORD	929005A	E2HZ5230Z	FORD	86650M
B7TZ5230A	FORD	86136M	D1HS5225AA	FORD	86300M	D9TZ5230BK	FORD	86675M	E2HZ5230Z	FORD	86650M
BB234	AP	89524K	D2HA5230AA	FORD	86108M	D9TZ5230BM	FORD	86675M	E2HZ5230S	FORD	86183M
BB300	AP	89525B	D2HS5230KA	FORD	86106M	D9TZ5230BT	FORD	86675M	E2HZ5A231A	FORD	89531K
BB312	AP	89526K	D2HZ5230A	FORD	86108M	DA3590811	HENDRICK	86125M	E2HZ5A231A	FORD	89531K
BB400	AP	89527B	D3HA5225AAA	FORD	86113M	DA3590820	HENDRICK	86300M	E3HS5225BA	FORD	86501M
BB500	AP	89528B	D3HA5225SA	FORD	86300M	DA3590823	HENDRICK	86108M	E3HT5225A	FORD	86108M
BS2159112	ORIONBUS	89622K	D3HA5230FA	FORD	86102M	DA3590825	HENDRICK	86108M	E3HT5225FB	FORD	86221M
BS2159114	ORIONBUS	89623K	D3HS5230GA	FORD	86118M	DA3590827	HENDRICK	86139M	E3HT5225RA	FORD	86200M
BX0376	ELGNSWPR	86119M	D3HZ5230B	FORD	86502M	DA3590829	HENDRICK	86213M	E3HT5225SA	FORD	86220M
C0DD5230A	FORD	86136M	D3HZ5230D	FORD	86113M	DA359087	HENDRICK	86115M	E3HZ5230A	FORD	86221M
C138018	LORAIN	86206M	D3HZ5230F	FORD	86300M	DA359088	HENDRICK	86132M	E3HZ5230B	FORD	86502M
C1TT5230AR	FORD	86136M	D3HZ5230M	FORD	86102M	DA359088	WARNERSW	86147M	E3HZ5230C	FORD	86501M
C1TT5230AS	FORD	86136M	D3HZ5255A	FORD	86113M	DV0201007007	NEOPART	90368B	E3HZ5230J	FORD	86503M
C1TT5230AT	FORD	86133M	D3TZ5230D	FORD	86675M	DVZ5230D	FORD	86675M	E3HZ5230S	FORD	86183M
C1TT5230BD	FORD	86200M	D418219	DAEWOO	89543K	DX3590812	HENDRICK	86133M	E3UZ5230F	FORD	86675M
C1TZ5230AS	FORD	86136M	D45256	CASE	49125A	DX3590813	HENDRICK	86102M	E3UZ5230G	FORD	86675M
C1TZ5230BD	FORD	86118M	D49456	LORAIN	86173M	DX3590816	HENDRICK	86108M	E3UZ5230H	FORD	86675M

Cross Reference by Number

OEM No.	Manuf.	Our No.	OEM No.	Manuf.	Our No.	OEM No.	Manuf.	Our No.	OEM No.	Manuf.	Our No.
E3UZ5230J	FORD	86675M	F18685	CASE	86177M	HD30039	RIKER	86139M	J009428	DON	89744C
E4HT5230BA	FORD	86184M	F19008	FAIRMONT	86206M	HD30139	RIKER	86139M	J009429	DON	89748A
E4HZ5230A	FORD	86522M	F1HS5225FA	FORD	24050A	HD305	RIKER	86139M	J009498	DON	89996C
E4HZ5230A	FORD	86522M	F1HS5225FA	FREIGHTL	24050A	HD3078	RIKER	86119M	J009499	DON	89995C
E4HZ5230B	FORD	86183M	F1HS5225GA	FORD	24051A	HD3079	RIKER	86139M	J009500	DON	89994C
E4HZ5230B	FORD	86183M	F1HT5230AA	FORD	86695M	HD325	RIKER	86137M	J009518	DON	90470K
E4HZ5230E	FORD	86183M	F1HZ5230A	FORD	86695M	HD350	RIKER	86188M	J009530	DON	90465C
E4HZ5230E	FORD	86183M	F3HZ5A281A	FORD	89571K	HD359	RIKER	86150M	J009539	DON	89116A
E56990	LORAIN	86125M	F40070	FAIRMONT	49160A	HD363	RIKER	86150M	J009547	DON	89784C
E5HZ5230A	FORD	86220M	F6HT5225A2A	FORD	86535M	HD400	RIKER	86189M	J009548	DON	89105C
E5HZ5230B	FORD	86200M	F6HT5225L2A	FORD	86531M	HD403	RIKER	86127M	J009560	DON	90465A
E5T5230AR	FORD	86675M	F6HT5225NA1	FORD	86626M	HD404	RIKER	86127M	J009565	DON	900068A
E650006	AMERHOIS	86131M	F8HS5225AA	FORD	86531M	HD405	RIKER	86127M	J009604	DON	90354A
E650097	CONTINDV	86132M	FD275F72	BILNGSLY	929005A	HD500	RIKER	86132M	J009605	DON	90355A
E650097	AMERHOIS	86132M	FD275R72	BILNGSLY	929005A	HD501	RIKER	86132M	J009607	DON	90358A
E650102	AMERHOIS	86106M	FD3208F	BILNGSLY	925005A	HD6017	RIKER	86168M	J009612	DON	89500K
E650103	AMERHOIS	86159M	FD400F72	BILNGSLY	929007A	HD7034	RIKER	86213M	J009613	DON	89512K
E6HS5C208AA	FORD	89440E	FD660C	BILNGSLY	926011A	HD7360	RIKER	86685M	J009614	DON	89502K
E6HS5C208AA	FORD	89440E	FD660EXT	BILNGSLY	924004A	HD7713	RIKER	86185M	J009617	DON	89509K
E6HS5C208BA	FORD	89440E	FD660F	BILNGSLY	929027A	HT739	FMC	86175M	J009619	DON	89532K
E6HS5C208BA	FORD	89440E	FD660R	BILNGSLY	929027A	HW0449	WABCO	86131M	J009620	DON	89105A
E6HZ5A231A	FORD	90364A	FDEX600	BILNGSLY	923008A	IH2180	FMC	86106M	J009621	DON	89105C
E7HS5225AB	FORD	86655M	FDEX780	BILNGSLY	923008A	IH3208F	BILNGSLY	926005A	J009624	DON	90368A
E7HS5225HA	FORD	86531M	FW593360	FORD	86137M	IH3208G	BILNGSLY	929011A	J009632	DON	900073A
E7HT5225CA	FORD	86529M	FW75168	FINN	89883A	IH360	BILNGSLY	925005A	J009633	DON	900074A
E7HZ5230A	FORD	86529M	FW75169	FINN	89123A	IH360A	BILNGSLY	929016A	J009636	DON	900077A
E7HZ5246G	FORD	923008A	FW75170	FINN	86180M	IH393840R91	CUBCADET	14472T	J009637	DON	900078A
E7HZ5246N	FORD	924004A	G1017916	NOVABUS	90378B	IH859	FMC	86173M	J009640	DON	900081A
E7HZ5255A	FORD	926011A	G1019097	MCI	90358B	J000110	DON	929002A	J009641	DON	900082A
E7HZ5A231C	FORD	89501K	G15571897	VOLVO	21063A	J000117	DON	929004A	J009644	DON	900085A
E7TZ5230H	FORD	86675M	G2079904	VOLVO	18306A	J000121	DON	929003A	J009645	DON	900086A
E8HS5225MA	FORD	22380A	G45239	CASE	11396T	J000126	DON	929024A	J009647	DON	89530K
E8HT5225A2A	FORD	86529M	G45264	CASE	11396T	J000127	DON	929024A	J009648	DON	89881A
E8HT5225AEA	FORD	86535M	G5003195	MOTORCO	89528K	J000128	DON	929005A	J009649	DON	89256A
E8HT5225ALA	FORD	86626M	G5010400	MOTORCO	89923C	J000129	DON	90615K	J009650	DON	89883A
E8HT5225AMA	FORD	86626M	G5010400	MOTORCO	89923C	J000130	DON	929025A	J014337	DON	89261A
E8HT5225B2A	FORD	86698M	G5TZ5230A	FORD	86118M	J000137	DON	929027A	J014338	DON	89263A
E8HT5225C2A	FORD	86697M	H200	AP	90929K	J000138	DON	929007A	J014339	DON	89160A
E8HT5225G2A	FORD	86530M	H200	TRUCKEX	90929K	J000139	DON	89662K	J014340	DON	89161A
E8HT5225K2A	FORD	86503M	H212	AP	90916K	J000140	DON	89664K	J014341	DON	89162A
E8HT5225KA	FORD	86503M	H212	TRUCKEX	90916K	J000200	DON	90873A	J014623	DON	90909C
E8HT5225L2A1	FORD	86626M	H214	AP	90915K	J000201	DON	90874A	J018109	DON	89338A
E8HT5225N2A	FORD	86626M	H234	AP	89544K	J000202	DON	90875A	J024657	DON	89740K
E8HT5225R2A	FORD	86196M	H234	DON	89544K	J000203	DON	90877A	J024658	DON	89742K
E8HT5225SA	FORD	86196M	H234	TRUCKEX	89544K	J000210	DON	89521B	J024673	DON	89218C
E8HZ5230A	FORD	86196M	H238	AP	90916K	J000211	DON	89523K	J024731	DON	89211A
E8HZ5230AA	FORD	86535M	H238	DON	90916K	J000212	DON	89522B	J024735	DON	89022A
E8HZ5230AE	FREIGHTL	86626M	H258	AP	89544K	J000213	DON	89524K	J024737	DON	89025A
E8HZ5230AE	FORD	86626M	H300	AP	89545K	J000214	DON	89525K	J024739	DON	89028A
E8HZ5230AF	FORD	86626M	H300	DON	89545K	J000215	DON	89526K	J024746	DON	89055A
E8HZ5230B	FORD	86196M	H300	TRUCKEX	89545K	J000216	DON	89527K	J024747	DON	89058A
E8HZ5230D	FREIGHTL	86503M	H300P	TRUCKEX	900041K	J000217	DON	90464K	J024748	DON	89043A
E8HZ5230D	FORD	86503M	H312	AP	89547K	J000218	DON	89528K	J024749	DON	89043C
E8HZ5230E	FORD	86697M	H312	DON	89547K	J000219	DON	89529K	J024750	DON	89046A
E8HZ5230F	FORD	86698M	H312P	TRUCKEX	90867A	J000220	DON	90929K	J024751	DON	89046C
E8HZ5230G	FORD	86626M	H314	AP	89546K	J000221	DON	90916K	J024752	DON	89600K
E8HZ5230L	FORD	86530M	H314	DON	89546K	J000222	DON	90915K	J024753	DON	89603K
E8HZ5230R	FORD	86529M	H37006	GALLION	86173M	J008465	DON	89519K	J024754	DON	89606K
E8HZ5230R	FORD	86529M	H400	AP	89548K	J008680	DON	89784A	J024755	DON	89609K
E8HZ5230T	FORD	86529M	H400	DON	89548K	J008681	DON	900055A	J024757	DON	89055C
E8HZ5230T	FORD	86529M	H400P	TRUCKEX	900043K	J008682	DON	89232A	J024758	DON	89058C
E8HZ5230W	FORD	86529M	H412	AP	90092A	J008868	DON	89640K	J024835	DON	89607K
E8HZ5230W	FORD	86529M	H500	AP	89549K	J008870	DON	89648K	J024836	DON	89728K
E8HZ5A231E	FORD	89531K	H500	DON	89549K	J008872	DON	89710K	J024837	DON	89314K
E8TZ5230A	FORD	86675M	H5825101	WESTSTAR	89542K	J008880	DON	89712K	J024838	DON	89723K
E9HZ5230A	FORD	86522M	H5825102	WESTSTAR	89543K	J008896	DON	89719K	J024849	DON	89604K
EE100601	OSHKOSH	86147M	H600	AP	89550K	J008897	DON	89620K	J024850	DON	89618K
EN164	WINPOWER	86173M	H600	DON	89550K	J008942	DON	89279A	J028528	DON	89897A
EOHZ5230A	FORD	86153M	HC2738	FMC	49135A	J008943	DON	89250A	J028532	DON	90983A
EOHZ5230A	FORD	86153M	HD200	RIKER	86136M	J008982	DON	89721K	J034673	DON	89729K
EOHZ5230A	FORD	86153M	HD201	RIKER	86136M	J008983	DON	89722K	J034674	DON	89733K
EOHZ5230B	FORD	86153M	HD2500	RIKER	86137M	J009298	DON	89748A	J034703	DON	89026C
EOHZ5230B	FORD	86153M	HD2501	RIKER	86137M	J009299	DON	89995C	J034725	DON	89036C
EX250300	KOHLER	49025N	HD2502	RIKER	86137M	J009300	DON	89995C	J034743	DON	89608K
F012611	FAIRMONT	86136M	HD2503	RIKER	86137M	J009301	DON	89098A	J034744	DON	89611K
F0HT5225AA	FORD	86535M	HD25037	RIKER	86137M	J009309	DON	89118A	J034746	DON	89053C
F0HZ5230D	FORD	86535M	HD2510	RIKER	86137M	J009316	DON	90488A	J034785	DON	89605K
F0HZ5230F	FORD	86695M	HD25739	RIKER	86137M	J009317	DON	900065A	J034786	DON	89619K
F0UZ5230F	FORD	86695M	HD271	RIKER	86183M	J009393	DON	89966K	J038603	DON	90922A
F120959	JDEERE	90587K	HD27539	RIKER	86506M	J009399	DON	89507K	J038608	DON	90823A
F122164	JDEERE	90885A	HD300	RIKER	86187M	J009427	DON	89744C	J038611	DON	90980A

Cross Reference by Number

OEM No.	Manuf.	Our No.	OEM No.	Manuf.	Our No.	OEM No.	Manuf.	Our No.	OEM No.	Manuf.	Our No.
J038612	DON	90979A	K18014764L	KENWORTH	90980C	M070066	DON	49135A	M101169	DON	201572N
J054743	DON	900088C	K18014764L	KENWORTH	90980C	M070094	DON	86300M	M101170	DON	201573N
J054745	DON	89221C	K18014764R	KENWORTH	90979C	M070185	DON	86164M	M101171	DON	201574N
J068182	DON	89887A	K18014764R	KENWORTH	90979C	M080018	DON	20153T	M10127	PACCAR	86127M
J068185	DON	89901A	K18014766	KENWORTH	90981A	M080024	DON	49140A	M10130	PACCAR	86130M
J074608	DON	89986C	K18015593	KENWORTH	89117A	M085023	DON	86139M	M1014	PACCAR	86144M
J092679	DON	89941A	K180B10742R	KENWORTH	89901A	M085056	DON	86119M	M10144	PACCAR	86144M
J092689	DON	89951A	KC3015	WABCO	86178M	M085078	DON	86119M	M10145	PACCAR	86145M
J094941	DON	90993A	KM1105	RIKER	86137M	M085080	DON	86119M	M10196	PACCAR	86196M
J094942	DON	90981A	KM3103	RIKER	86184M	M085084	DON	86192M	M10305	PACCAR	86305M
J190002	DON	90463A	KM3105	RIKER	86139M	M085090	DON	86192M	M10514	PACCAR	86514M
J190003	DON	89924A	L09379	CASE	86147M	M085171	DON	86127M	M10531	PACCAR	86531M
J190004	DON	89924C	L09381	CASE	86125M	M085172	DON	86183M	M10547	PACCAR	86547M
J190009	DON	89124A	L101421	CASE	17123N	M085182	DON	86135M	M10682	PACCAR	86682M
J190011	DON	89123A	L104036	CASE	Q25344	M085189	DON	86184M	M10713	PACCAR	86713M
J190013	DON	89234A	L110478	CASE	49130A	M085206	DON	86192M	M10739	PACCAR	86739M
J190014	DON	89235A	L13782	CASE	86150M	M085267	DON	86722M	M10740	PACCAR	86740M
J190016	DON	89115C	L246811	PETTIBON	86173M	M085308	DON	86522M	M110012	DON	86500M
J190017	DON	89125A	L40030	RIKER	900073A	M085407	DON	201560N	M110014	DON	86672M
J190019	DON	89117C	L40030NE	RIKER	900077A	M085408	DON	201561N	M110015	DON	86501M
J190020	DON	89127A	L40060	RIKER	900081A	M085409	DON	201562N	M110016	DON	86221M
J190023	DON	89074A	L40060NE	RIKER	900085A	M085410	DON	201563N	M110028	DON	86529M
J190024	DON	89074C	L50030	RIKER	900074A	M085411	DON	201564N	M110077	DON	86705M
J190026	DON	89781C	L50030NE	RIKER	900078A	M090009	DON	86175M	M110189	DON	86529M
J190027	DON	89075A	L50060	RIKER	900082A	M090072	DON	86145M	M110479	DON	86724M
J190028	DON	89075C	L50060NE	RIKER	900086A	M090074	DON	86132M	M110480	DON	86724M
J190032	DON	89076A	L78140	LEROI	86173M	M090091	DON	49150A	M110481	DON	86727M
J190035	DON	89086A	L78147	LEROI	86172M	M090146	DON	86113M	M110482	DON	86756M
J190042	DON	89253A	L78152	LEROI	86177M	M090158	DON	86106M	M110483	DON	86725M
J190044	DON	89254A	L78157	LEROI	86150M	M090210	DON	86206M	M120100	DON	86125M
J190045	DON	89255A	L8461	LINCOLNE	49120B	M090280	DON	86153M	M120108	DON	86147M
J190046	DON	90560A	L9381	CAT	86125M	M090295	DON	86597M	M120154	DON	86115M
J190049	DON	89282A	L9397	CAT	86147M	M090301	DON	86193M	M120197	DON	86752M
J190050	DON	90350A	LA14502	PETTIBON	49135A	M090362	DON	86144M	M120210	DON	86221M
J190052	DON	90352A	LC12PU1003P1	KOBELCO	89573K	M090388	DON	86148M	M120225	DON	86147M
J190053	DON	90353A	LC12PU1005P1	KOBELCO	90875A	M090391	DON	20620T	M120235	DON	86194M
J190054	DON	90357A	LK503	RIKER	90979A	M090520	DON	86512M	M120366	DON	86503M
J190055	DON	90359A	LK504	RIKER	90980A	M090534	DON	86153M	M120367	DON	86608M
J190057	DON	90361A	LL32986	PETTIBON	49125A	M090535	DON	86739M	M120382	DON	86149M
J190059	DON	90363A	LL84726	PETTIBON	86173M	M090544	DON	86108M	M120566	DON	86542M
J190060	DON	90364A	LL84735	PETTIBON	86125M	M090545	DON	86514M	M120592	DON	86753M
J190061	DON	90365A	LL84737	PETTIBON	86139M	M090547	DON	86537M	M120747	DON	201575N
J190062	DON	90367A	LL84786	PETTIBON	86177M	M090548	DON	86545M	M120748	DON	201576N
J190063	DON	90369A	LL84788	PETTIBON	86137M	M090563	DON	86185M	M120749	DON	201577N
J190072	DON	89759K	LL84796	PETTIBON	86150M	M090594	DON	86560M	M120750	DON	201578N
J190073	DON	89772K	LM6854920840	MERCEDES	90366B	M090595	DON	200238N	M120751	DON	201579N
J240003	DON	89612K	LM6854920840	MERCEDES	90366B	M090596	DON	86139M	M122300	DON	86180M
J240004	DON	89614K	LS12PU1003P1	KOBELCO	89520K	M090680	DON	86536M	M20125	PACCAR	86125M
J240005	DON	89616K	LT3550	RIKER	86300M	M090680	DON	86536M	M20137	PACCAR	86137M
J240007	DON	89730K	LT400	RIKER	86144M	M090781	DON	86514M	M20139	PACCAR	86139M
J240008	DON	89005C	LT500	RIKER	86150M	M090781	DON	86514M	M20147	PACCAR	86147M
J240014	DON	89016A	M001327	DON	89194U	M091046	DON	201565N	M20153	PACCAR	86153M
J240016	DON	89035C	M001338	DON	89193U	M091047	DON	201566N	M20164	PACCAR	86164M
J280003	DON	89889A	M045123	DON	49110U	M091048	DON	201567N	M20183	PACCAR	86183M
J340005	DON	89615K	M045237	DON	86177M	M091049	DON	201568N	M20185	PACCAR	86185M
J340021	DON	89020C	M060005	DON	86172M	M091050	DON	201569N	M20213	PACCAR	86213M
J340022	DON	89023C	M060037	DON	49120B	M100016	DON	49160A	M20512	PACCAR	86512M
J340023	DON	89029C	M060038	DON	49115U	M100043	DON	86118M	M20529	PACCAR	86529M
J380001	DON	89882A	M060055	DON	86136M	M100048	DON	86168M	M20536	PACCAR	86536M
J380002	DON	89892A	M060158	DON	86190M	M100049	DON	86133M	M234	BILNGSLY	86164M
J380003	DON	90967A	M060232	DON	86136M	M100052	DON	86151M	M300	BILNGSLY	86139M
J480001	DON	89893A	M060249	DON	86190M	M100058	DON	86305M	M30510	PACCAR	86510M
J540008	DON	90438C	M060479	DON	201550N	M100104	DON	86215M	M30511	PACCAR	86511M
J640001	DON	89916A	M060480	DON	201551N	M100213	DON	86526M	M30537	PACCAR	86537M
J640005	DON	89293C	M060481	DON	201552N	M100463	DON	86130M	M3208	BILNGSLY	86185M
J640007	DON	89296C	M060482	DON	201553N	M100464	DON	86200M	M3661	BILNGSLY	86557M
J640008	DON	89296A	M060483	DON	201554N	M100465	DON	86682M	M370	BILNGSLY	86183M
J640009	DON	90589C	M065030	DON	49125A	M100466	DON	86544M	M392	BILNGSLY	86184M
J640012	DON	89920A	M065034	DON	86137M	M100580	DON	86531M	M404	BILNGSLY	86185M
J640013	DON	89920C	M065042	DON	86137M	M100582	DON	86196M	M466	BILNGSLY	86512M
K0773421	KENWORTH	90358A	M065044	DON	86191M	M100585	DON	86531M	M466	BILNGSLY	86512M
K130166	KENWORTH	90956A	M065065	DON	86137M	M100695	DON	86547M	M600	BILNGSLY	86529M
K16844	KENWORTH	86108M	M065071	DON	86178M	M100740	DON	86533M	M800N	BILNGSLY	86502M
K16844	PETERBIL	86108M	M065072	DON	86191M	M100741	DON	86196M	M800T	BILNGSLY	86502M
K16854	PETERBIL	86531M	M065138	DON	201555N	M100807	DON	86626M	M800T	BILNGSLY	86502M
K16854	KENWORTH	86531M	M065139	DON	201556N	M100815	DON	86788M	M900	BILNGSLY	86185M
K16858	KENWORTH	86196M	M065140	DON	201557N	M100845	DON	86544M	M90715	WABCO	49150A
K16948012	KENWORTH	90983A	M065141	DON	201558N	M10102	PACCAR	86102M	MBR0201007004	NEOPART	89797K
K18010742R	KENWORTH	89901A	M065142	DON	201559N	M10108	PACCAR	86108M	MC632928	MITSUBIS	86690M
K180109612CP	KENWORTH	89046C	M070008	DON	86173M	M101167	DON	201570N	MD21020000	AMGENRL	18861N
K180109660CP	KENWORTH	89296C	M070028	DON	86150M	M101168	DON	201571N	MFM100165	KENWORTH	86130M

Cross Reference by Number

OEM No.	Manuf.	Our No.	OEM No.	Manuf.	Our No.	OEM No.	Manuf.	Our No.	OEM No.	Manuf.	Our No.
MFM100165	PETERBIL	86130M	NMC89606K	FREIGHTL	89606K	P206349	DON	89118A	P206604	DON	89505K
MFM100172	KENWORTH	86130M	NMC89609K	FREIGHTL	89609K	P206350	DON	89109A	P206605	DON	89506K
MFM100172	PETERBIL	86130M	NMC89611K	FREIGHTL	89611K	P206353	DON	89106C	P206606	DON	89513K
MFM100295	KENWORTH	86130M	NMC89759K	FREIGHTL	89759K	P206363	DON	89246A	P206607	DON	89503K
MFM100295	PETERBIL	86130M	NMC89784C	FREIGHTL	89784C	P206364	DON	89247A	P206608	DON	89566K
MFM100410	KENWORTH	86130M	NMC89924C	FREIGHTL	89924C	P206365	DON	89248A	P206610	DON	89568K
MFM100410	PETERBIL	86130M	NMC89964K	FREIGHTL	89964K	P206366	DON	89250A	P206611	DON	89569K
MFM100580	PETERBIL	86531M	NMC89966K	FREIGHTL	89966K	P206367	DON	89164A	P206613	DON	89531K
MFM100582	PETERBIL	86196M	NMC90378A	FREIGHTL	90378B	P206368	DON	89165A	P206615	DON	89967K
MGK103	PACCAR	89763K	NMC90378A	FREIGHTL	90378B	P206369	DON	89166A	P206641	DON	89775K
MGK104	PACCAR	89767K	NMC90547K	FREIGHTL	90547B	P206370	DON	89167A	P206849	DON	89662K
MGK94	PACCAR	89966K	NMC90842C	FREIGHTL	90842C	P206371	DON	89263A	P206850	DON	89664K
ML11283	GMC	89520K	NMC90895U	FREIGHTL	90895U	P206372	DON	89160A	P206851	DON	89665K
ML112841	GMC	90875A	NMC90902K	FREIGHTL	90902K	P206373	DON	89161A	P206926	DON	929024A
ML112842	GMC	90877A	NMC90909C	FREIGHTL	90909C	P206374	DON	89162A	P206927	DON	89142A
ML11285	GMC	89173A	NMC90910A	FREIGHTL	90910A	P206375	DON	89163A	P206927	DON	89142A
ML11286	GMC	89187C	OV40032	RIKER	86125M	P206378	DON	89015A	P207281	DON	89214A
ML12333	GMC	90877A	OV406	RIKER	86133M	P206379	DON	89018A	P207282	DON	89216A
MNC86116M	FREIGHTL	86116M	OV409	RIKER	86213M	P206380	DON	89037A	P207283	DON	89218A
MPM090141	PETERBIL	86108M	OV414	RIKER	86133M	P206381	DON	89042A	P207285	DON	89021A
MPM090161	KENWORTH	86102M	OV449	RIKER	86213M	P206382	DON	89045A	P207286	DON	89024A
MPM090161	PETERBIL	86102M	P0187300	FWD	86200M	P206383	DON	89048A	P207287	DON	89027A
MPM090167	KENWORTH	86102M	P04435300	BLOUNT	86108M	P206384	DON	89155C	P207288	DON	89217A
MPM090197	PETERBIL	86102M	P1003953	ATHEY	89430E	P206385	DON	89156C	P207289	DON	89031A
MPM100106	KENWORTH	86130M	P104100	OSHKOSH	89187C	P206386	DON	89045C	P207290	DON	89226A
MPM100106	PETERBIL	86130M	P1906	CHICAGOP	86175M	P206391	DON	89019C	P207291	DON	89227A
MPM100127	KENWORTH	86195M	P2035	CHICAGOP	86173M	P206393	DON	89130A	P207292	DON	89030A
MPM100127	PETERBIL	86195M	P20352	CHICAGOP	86139M	P206394	DON	89131A	P207293	DON	89051A
MPM100338	KENWORTH	86195M	P205834	DON	89775K	P206395	DON	89132A	P207294	DON	89054A
MPM100338	PETERBIL	86195M	P205976	DON	90538A	P206396	DON	89133A	P207295	DON	89057A
MR200	RIKER	49120B	P206280	DON	89073A	P206397	DON	89091A	P207296	DON	89060A
MR250	RIKER	49125A	P206281	DON	89077A	P206398	DON	89093A	P207297	DON	89145A
MR300	RIKER	49130A	P206282	DON	900064A	P206399	DON	89095A	P207298	DON	89146A
MR350	RIKER	49135A	P206283	DON	89075A	P206400	DON	89097A	P207299	DON	89217C
MR400	RIKER	49140A	P206284	DON	89076A	P206403	DON	89541K	P207300	DON	89031C
MR500	RIKER	49150A	P206285	DON	89780C	P206404	DON	89542K	P207301	DON	89226C
MS3555	RIKER	89880A	P206286	DON	89781C	P206405	DON	89543K	P207302	DON	89227C
MSM090142	KENWORTH	86108M	P206297	DON	89940A	P206406	DON	89544K	P207306	DON	89218C
MSM090142	PETERBIL	86108M	P206298	DON	89950A	P206407	DON	89519K	P207308	DON	89145C
MTM110078	FREIGHTL	86705M	P206300	DON	90539A	P206407	DON	89519K	P207309	DON	89146C
MUF20006	WORTHINT	86177M	P206301	DON	89141A	P206408	DON	89546K	P207312	DON	89037C
MUF57	WORTHINT	86173M	P206302	DON	89143A	P206409	DON	89547K	P207314	DON	89021C
MUM090022	KENWORTH	86108M	P206304	DON	90909A	P206410	DON	89548K	P207316	DON	89027C
MUM090022	PETERBIL	86108M	P206305	DON	89146A	P206411	DON	89549K	P207317	DON	89030C
N024782	FAIRMONT	49120B	P206306	DON	89150A	P206509	DON	89771K	P207318	DON	89051C
N16165	NOVABUS	90368B	P206308	DON	89151A	P206510	DON	89761K	P207319	DON	89054C
N21470A	DIAMONDR	86131M	P206309	DON	89153A	P206511	DON	89762K	P207320	DON	89057C
NM0201007005	NEOPLAN	89796K	P206310	DON	89154A	P206512	DON	89763K	P207321	DON	89060C
NM0201007006	NEOPLAN	90366B	P206311	DON	90913A	P206513	DON	89763K	P207322	DON	89110A
NM0201007006	NEOPLAN	90366B	P206313	DON	89271A	P206516	DON	89535K	P207324	DON	89111A
NMC22867A	FREIGHTL	86533M	P206314	DON	89274A	P206517	DON	89538K	P207325	DON	89233A
NMC22867ATAN	FREIGHTL	86533M	P206315	DON	89275A	P206518	DON	89539K	P207326	DON	89113A
NMC24051A	FREIGHTL	24051A	P206316	DON	89276A	P206519	DON	89540K	P207328	DON	89114A
NMC86130M	FREIGHTL	86130M	P206317	DON	89277A	P206520	DON	89537K	P207329	DON	89115A
NMC86503M	FREIGHTL	86503M	P206318	DON	89278A	P206521	DON	89551K	P207330	DON	89925A
NMC86535M	FREIGHTL	86535M	P206319	DON	89168A	P206523	DON	90076A	P207331	DON	89117A
NMC86626M	FREIGHTL	86626M	P206320	DON	89170A	P206525	DON	90079A	P207332	DON	900061A
NMC86630M	FREIGHTL	86630M	P206322	DON	89172A	P206526	DON	90080A	P207333	DON	89098A
NMC86655M	FREIGHTL	86655M	P206323	DON	89173A	P206539	DON	89748A	P207338	DON	90459A
NMC86672M	FREIGHTL	86672M	P206324	DON	89182A	P206541	DON	89748A	P207339	DON	89784A
NMC86682M	FREIGHTL	86682M	P206325	DON	89184A	P206543	DON	89744C	P207340	DON	90460A
NMC86695M	FREIGHTL	86695M	P206326	DON	89185A	P206546	DON	89740K	P207341	DON	900057A
NMC86772M	FREIGHTL	86772M	P206327	DON	89186A	P206547	DON	89742K	P207345	DON	89105C
NMC89058C	FREIGHTL	89058C	P206328	DON	89187A	P206552	DON	89613K	P207346	DON	89107C
NMC89107A	FREIGHTL	89107A	P206331	DON	929002A	P206553	DON	89617K	P207347	DON	89081A
NMC89162A	FREIGHTL	89162A	P206333	DON	929004A	P206554	DON	89727K	P207349	DON	89082A
NMC89163A	FREIGHTL	89163A	P206334	DON	89685K	P206555	DON	89731K	P207350	DON	89242A
NMC89218C	FREIGHTL	89218C	P206335	DON	89686K	P206557	DON	89729K	P207350	DON	89242A
NMC89296A	FREIGHTL	89296A	P206336	DON	89687K	P206558	DON	89733K	P207351	DON	89083A
NMC89298C	FREIGHTL	89298C	P206337	DON	89688K	P206560	DON	89642K	P207352	DON	89087A
NMC89309K	FREIGHTL	89309K	P206338	DON	89698K	P206561	DON	89643K	P207353	DON	89082A
NMC89450A	FREIGHTL	89450E	P206339	DON	900048A	P206562	DON	89644K	P207354	DON	900069A
NMC89450A	FREIGHTL	89450E	P206340	DON	89101A	P206563	DON	89645K	P207356	DON	89071A
NMC89519K	FREIGHTL	89519K	P206341	DON	89102A	P206564	DON	89622K	P207361	DON	89236A
NMC89526K	FREIGHTL	89526B	P206342	DON	89103A	P206565	DON	89623K	P207362	DON	89090A
NMC89526K	FREIGHTL	89526B	P206343	DON	89104A	P206566	DON	89524K	P207363	DON	89092A
NMC89527K	FREIGHTL	89527K	P206344	DON	89105A	P206567	DON	89625K	P207364	DON	89094A
NMC89528K	FREIGHTL	89528K	P206345	DON	89106A	P206600	DON	89556K	P207365	DON	89096A
NMC89539K	FREIGHTL	89539K	P206346	DON	900059A	P206601	DON	89557K	P207366	DON	89236A
NMC89548K	FREIGHTL	89548K	P206347	DON	89107A	P206602	DON	89558K	P207367	DON	89661K
NMC89549K	FREIGHTL	89549K	P206348	DON	89108A	P206603	DON	89559K	P207368	DON	89663K

Cross Reference by Number

OEM No.	Manuf.	Our No.	OEM No.	Manuf.	Our No.	OEM No.	Manuf.	Our No.	OEM No.	Manuf.	Our No.
P207372	DON	89641K	P216191	DON	89212A	R41889	CASE	16730T	U214	AP	90915K
P207374	DON	89646K	P216192	DON	89213A	R500204	JDEERE	89096A	V18827	NEWHOLLA	900044K
P207377	DON	89621K	P216193	DON	89215A	RCSK15040	AMGENRL	89513K	V3714	INTERNTL	86188M
P207379	DON	89626K	P216196	DON	89219A	RCSK15127	AMGENRL	89512K	VP0644	FATEROOT	86175M
P207402	DON	89283A	P216200	DON	89053C	RCSK21289	AMGENRL	89503K	VP0673	FATEROOT	86173M
P207405	DON	89261A	P216201	DON	89985A	RCSK212891	AMGENRL	89520K	VP20093	FATEROOT	86115M
P207408	DON	89266A	P216202	DON	89985C	RCSK212892	AMGENRL	89507K	VP20096	FATEROOT	86203M
P207411	DON	89249A	P216205	DON	89988C	RE20224	JDEERE	18901T	X004478	DON	89525W
P207413	DON	89251A	P216206	DON	89223A	RE48944	JDEERE	89505K	X004480	DON	89526W
P207414	DON	89252A	P216207	DON	89224A	RE500329	JDEERE	89560B	X004482	DON	89527W
P207415	DON	89140A	P216208	DON	89223C	RH04066	OSHKOSH	89216A			900274A
P207419	DON	89157A	P216209	DON	89224C	RH102648	OSHKOSH	89046A			(Upgrade)
P207559	DON	89147A	P216210	DON	90447C	RH103339	OSHKOSH	89046A	X004484	DON	89528W
P207566	DON	89961K	P216211	DON	90449C	RH104063	OSHKOSH	89074A			90273A
P207567	DON	89959K	P216212	DON	90450C	RH106822	OSHKOSH	89045A			(Upgrade)
P207569	DON	89956K	P216213	DON	90443A	RH49688	GALION	86172M	X004962	DON	90464K
P207581	DON	89958K	P216214	DON	90444A	S11517	GMC	49150A	X005164	DON	90365A
P207584	DON	89971K	P216227	DON	89993C	S11914	GMC	49140A	X005207	DON	90555C
P207596	DON	89560K	P216228	DON	89994C	S20461	LINCOLNE	49115U	X005266	DON	90363A
P207598	DON	89570K	P216232	DON	90595C	S24645	LINCOLNE	49025N	X005833	DON	90368A
P207619	DON	89955K	P216237	DON	90439C	SD2492	SUPRP	89237A	X005834	DON	90546K
P207620	DON	89960K	P216238	DON	90440C	SE06824	PIERCEGO	86408M	X005835	DON	90547K
P207667	DON	89550K	P216239	DON	90442C	SK357642	HYSTER	86130M	X005921	DON	90364A
P207707	DON	89511K	P216240	DON	90451A	SP5201	WABCO	86125M	X005985	DON	90357A
P207784	DON	89519K	P216241	DON	90452A	SPA150	PACCAR	49115U	X006202	DON	90358A
P208315	DON	89713K	P216242	DON	90451C	SPA30	PACCAR	49130A	X006204	DON	90355A
P208316	DON	89714K	P216243	DON	90452C	SPA35	PACCAR	49135A	X006212	DON	90358A
P208317	DON	89723K	P216248	DON	89508K	SPA40	PACCAR	49140A	X007057	DON	90369A
P208318	DON	89715K	P216249	DON	89509K	SPA50	PACCAR	49150A	X007785	DON	90368A
P208319	DON	89724K	P216250	DON	89532K	SPA60	PACCAR	49160A	X007805	DON	90358A
P208324	DON	89020A	P216252	DON	89501K	SS191521	HYSTER	49140A	X007830	DON	90364A
P208326	DON	89050A	P216253	DON	89531K	ST7410136	WHITING	86213M	X007831	DON	90365A
P208330	DON	89035A	P216261	DON	89225C	T112	AP	90927K	X007832	DON	90352A
P208332	DON	89006A	P224586	DON	89221A	T134	AP	90928K	X007833	DON	90354A
P208334	DON	89036A	P224625	DON	89225A	T1477429	NACCO	89430E	X007834	DON	90355A
P208338	DON	89040A	P226147	Don	89625K	T158	AP	90928K	X1034634	ELGNSWPR	89640K
P208342	DON	89041A	P226156	DON	89723K	T158264	JDEERE	89881A	X1034730	ELGNSWPR	89110A
P208348	DON	89023A	P226158	DON	89724K	T178	AP	90914K	XB4102	SCHOOLBS	929027A
P208350	DON	89053A	P270531	DON	89417A	T200	AP	89541K	XB4105	SCHOOLBS	929007A
P208356	DON	89014A	P270532	DON	89420A	T212	AP	89543K	XB4110	SCHOOLBS	929027A
P208358	DON	89044A	P270533	DON	89422A	T214	AP	89542K	XB4112	SCHOOLBS	929007A
P208364	DON	89026A	P270534	DON	89425A	T234	AP	89544K	XB4117	SCHOOLBS	929027A
P208366	DON	89056A	P270535	DON	89427A	T234	TRUCKEX	89544K	XB4120	SCHOOLBS	929007A
P208372	DON	89017A	P270538	DON	89435A	T300	AP	89545K	XB452	SCHOOLBS	929027A
P208373	DON	89017C	P270539	DON	89440A	T300Z	TRUCKEX	89545K	XB460	SCHOOLBS	929027A
P208374	DON	89047A	P270540	DON	89445A	T312	AP	89547K	XB467	SCHOOLBS	929027A
P208380	DON	89029A	P270541	DON	89450A	T312Z	TRUCKEX	89547K	XB475	SCHOOLBS	929027A
P208382	DON	89059A	P270543	DON	89460A	T314	AP	89546K	XB480	SCHOOLBS	929027A
P208386	DON	89155A	P270837	DON	89440C	T314	TRUCKEX	89546K	XB495	SCHOOLBS	929027A
P208387	DON	89205A	P270838	DON	89450C	T400	AP	89548K	XB497	SCHOOLBS	929007A
P208388	DON	89222A	P271511	DON	89460C	T400Z	TRUCKEX	89548K	XB4AXF2	SCHOOLBS	924037A
P208389	DON	89222C	P306303	DON	89144A	T412Z	TRUCKEX	90092A	XB4M1	SCHOOLBS	86630M
P208392	DON	89156A	P70638	ATHEY	86106M	T500	AP	89549K	XC234M1	SCHOOLBS	86164M
P208393	DON	89019A	PB2601	KOMATSU	90376D	T500Z	TRUCKEX	89549K	XC4AXR6	SCHOOLBS	925002A
P208394	DON	89049A	PB3205	WABCO	86147M	T600	AP	89550K	XC4MD6	SCHOOLBS	86557M
P209910	DON	89990C	PGK53	PACCAR	89771K	T660Z	TRUCKEX	89550K	XC4TF11	SCHOOLBS	924027A
P209911	DON	89987C	PGK63	PACCAR	90857K	TB40010	BILINGSLY	929007A	XC4TF12	SCHOOLBS	924027A
P209912	DON	89989C	PM090141	KENWORTH	86108M	TCA51078	JDEERE	90914K	XC4TR1	SCHOOLBS	929012A
P209913	DON	89295C	PM16487T	JDEERE	16487T	TD1	MAREMONT	86137M	XD300	RIKER	86139M
P209914	DON	90608C	PPD0409586017	PACCAR	90983A	TD17	MAREMONT	86102M	XD4019	RIKER	86133M
P209916	DON	89918C	PPD0415653000	FREIGHTL	90987A	TD2	MAREMONT	86139M	XD407	RIKER	86131M
P209919	DON	89916C	PPD0415653000	PACCAR	90987A	TD20	MAREMONT	86144M	XD415	RIKER	86127M
P210110	DON	89510K	PPD0415686000	PACCAR	90987A	TD22	MAREMONT	86136M	XD419	RIKER	86139M
P211449	DON	89760K	PPD1652937C1	PACCAR	98889A	TG07530	COCKSHUT	14245T	XF370F2	SCHOOLBS	929005A
P211450	DON	89773K	PPD1657101C	PACCAR	98882A	TTA250	RIKER	90352A	XF370M	SCHOOLBS	86522M
P211613	DON	90191K	PPD1673907C1	PACCAR	90083A	TTA300	RIKER	90354A	XF370M1	SCHOOLBS	86522M
P211614	DON	90206K	PPD475306C2	PACCAR	89892A	TTA350	RIKER	90355A	XF370M2	SCHOOLBS	86522M
P211616	DON	89294C	PPD4ME21698	PACCAR	89897A	TTS300	RIKER	90364A	XF370T2	SCHOOLBS	929005A
P212346	DON	89309K	PPD4ME32603	PACCAR	90922A	TTS350	RIKER	90365A	XF69M	SCHOOLBS	86675M
P212347	DON	89313K	PPD4ME32612	PACCAR	98887A	U112	AP	90927K	XH345MD	SCHOOLBS	86184M
P213191	DON	89514K	PPD532383C1	PACCAR	90962A	U112	TRUCKEX	90927K	XH360XT	SCHOOLBS	925005A
P216165	DON	89073A	PPD532395C1	PACCAR	89893A	U134	AP	90928K	XH3M1	SCHOOLBS	86139M
P216168	DON	89240A	PPD582167C1	PACCAR	90823A	U134	TRUCKEX	90928K	XH404M1	SCHOOLBS	86521M
P216173	DON	89109C	PPD587519C2	PACCAR	90966A	U158	AP	90928K	XH412G	INTERNTL	90903K
P216174	DON	89231A	PPD587521C2	PACCAR	90967A	U178	AP	90914K	XH418G	INTERNTL	89606K
P216175	DON	89119A	PPDD8HZ5246M	PACCAR	90938A	U178	TRUCKEX	90914K	XH424G	INTERNTL	89607K
P216176	DON	900057A	R026594002	PETTIBON	49120B	U200	TRUCKEX	90929K	XH436G	INTERNTL	89608K
P216179	DON	89006C	R03536	ROYALTEK	90847A	U200	AP	90929K	XH459EM	INTERNTL	86740M
P216182	DON	900090C	R03782	ROYAL	89435E	U212	TRUCKEX	90916K	XH466EX	SCHOOLBS	926062A
P216186	DON	89228C	R18706	INGERSOL	86172M	U212	AP	90916K	XH4AX	SCHOOLBS	927010A
P216188	DON	90570C	R27575	CASE	12385T	U214	TRUCKEX	90915K	XH4M1	SCHOOLBS	86669M

Cross Reference by Number

OEM No.	Manuf.	Our No.	OEM No.	Manuf.	Our No.	OEM No.	Manuf.	Our No.	OEM No.	Manuf.	Our No.
XH4RCC	INTERNTL	89440E									
XH4TF8	SCHOOLBS	929016A									
XH4TF9	SCHOOLBS	929016A									
XH4TR3	SCHOOLBS	929011A									
XH518G	INTERNTL	89609K									
XH518SS	INTERNTL	89731K									
XH536SS	INTERNTL	89733K									
XH5510EM	INTERNTL	86682M									
XH559EM	INTERNTL	86739M									
XH69L2	SCHOOLBS	925014A									
XH69R	SCHOOLBS	926008A									
XH89440	INTERNTL	89440E									
XH89440A	INTERNTL	89440E									
XH89450A	INTERNTL	89450E									
YM12PU1002D1	KOBELCO	89525K									
YW12PU1004D1	KOBELCO	89571K									
Z600030129	ONAN	89450E									
Z600030129	ONAN	89450E									
ZF305	MAREMONT	49120B									
ZF306	MAREMONT	49125A									
ZF307	MAREMONT	49130A									
ZF308	MAREMONT	49135A									
ZF604	MAREMONT	49140A									
ZF605	MAREMONT	49150A									
ZF606	MAREMONT	86145M									
ZF615	MAREMONT	86183M									
ZF626	MAREMONT	86184M									
ZF855	MAREMONT	86125M									
ZF859	MAREMONT	86148M									
ZF860	MAREMONT	86213M									
ZF868	MAREMONT	86153M									
ZF869	MAREMONT	86185M									
ZF917	MAREMONT	86505M									
ZF947	MAREMONT	86536M									
ZFS90914K	INTERNTL	90914K									
ZH003	MAREMONT	86203M									
ZH008	MAREMONT	86164M									
ZH009	MAREMONT	86135M									
ZH012	MAREMONT	86557M									
ZH201	MAREMONT	86200M									
ZH202	MAREMONT	86131M									
ZH203	MAREMONT	86108M									
ZH206	MAREMONT	86102M									
ZH209	MAREMONT	86113M									
ZNL22705T	CASE	22705T									
ZNL645633	CASE	Q645633									
ZNL90873A	CASE	90873A									

04849T	Type 1 Muffler, Round	3-6	28413N	Type 5 Spark Arresting Muffler.....	3-15
05388T	Type 1 Allis Chalmers Muffler, Round.....	3-3	28544N	Type 5 Muffler, Round	3-15
09166T	Type 1 Dav Brown/Case/Cockshutt/IH Tractor Muffler.....	3-3	48210U	Type 1 Muffler, Round	3-3
10156T	Type 1 IH Vertical Tractor Muffler, Round.....	3-4	48215U	Type 1 Muffler, Round	3-3
10811T	Type 1 IH Tractor Muffler, Round.....	3-3	49024N	Screen Spark Arrestor	4-9
11026T	Type 1 JI Case Muffler, Round.....	3-5	49025N	Type 1 Muffler, Round Screen Spark Arrestor.....	3-3, 4-9
11396T	Type 1 JI Case Vertical Muffler, Round	3-3	49110U	Type 1 Spark Arrestor (CFM Rating 54).....	5-3
11650T	Type 1 Muffler, Oval.....	3-4	49115U	Type 1 Spark Arrestor (CFM Rating 165).....	5-3
11651T	Type 1 IH Tractor Muffler, Oval.....	3-4	49120B	Type 10 Spark Arrestor, Round.....	5-3
11669T	Type 4 JI Case Muffler, Oval	3-14	49125A	Type 1 Spark Arrestor (CFM Rating 450).....	5-3
11731T	Type 1 Muffler, Oval.....	3-4	49130A	Type 1 Spark Arrestor (CFM Rating 660).....	5-3
12036A	Type 3 Muffler, Round	3-13	49135A	Type 1 Spark Arrestor (CFM Rating 900).....	5-3
12385T	Type 3 JI Case Muffler, Oval	3-13	49140A	Type 1 Spark Arrestor (CFM Rating 1180).....	5-3
12417T	Type 5 Tractor Muffler, Round	3-15	49150A	Type 1 Spark Arrestor (CFM Rating 1840).....	5-3
13900T	Type 5 IH Tractor Muffler, Round.....	3-15	49160A	Type, Spark Arrestor, Round.....	5-3
13909T	Type 5 JI Case Muffler, Oval	3-15	86102M	Type 1 Muffler, Round	3-6, 5-4
13994T	Type 5 Spark Arresting Muffler, Round.....	3-15	86106M	Type 2 Muffler, Oval.....	3-8
14099T	Type 5 Spark Arresting Muffler, Round.....	3-15	86108M	Type 1 Muffler, Round	3-5, 5-4
14222T	Type 1 Massey Ferguson Muffler	3-3	86113M	Type 1 Muffler, Round	3-4
14245T	Type 1 Vertical Tractor Muffler, Round	3-3	86115M	Type 3 Muffler, Oval.....	3-13
14472T	Type 5 Garden Tractor Muffler, Round.....	3-15	86116M	Type 3 Muffler, Oval.....	3-13
14490T	Type 8 Garden Tractor Muffler, Round.....	3-21	86118M	Type 2 Muffler, Round	3-9
14663T	Type 2 JI Case Muffler, Oval	3-8	86119M	Type 2 Muffler, Round	3-8
15088T	Type 3 IH Tractor Muffler, Oval.....	3-13	86125M	Type 2 Muffler, Oval.....	3-9
15572T	Type 5 JI Case Muffler, Oval	3-16	86127M	Type 1 Muffler, Round	3-5
16487T	Type 1 IH Muffler, Round.....	3-3	86130M	Type 1 Muffler, Round	3-6, 5-4
16730T	Type 1 JI Case Crawler Muffler.....	3-3	86131M	Type 1 Muffler, Round	3-5
17120T	Type 5 Muffler, Round	3-16	86132M	Type 1 Muffler, Round	3-6
17123N	Type 5 Spark Arrestor, Oval	3-15	86133M	Type 3 Muffler, Round	3-13
17275T	Type 7 Muffler, Oval.....	3-18	86135M	Type 2A Muffler, Round.....	3-12
17704T	Type 1 Muffler, Oval.....	3-5	86136M	Type 2 Muffler, Round	3-8
18202T	Type 4 Muffler, Oval.....	3-14	86137M	Type 2 Muffler, Round	3-8
18901T	Type 1 Muffler, Oval.....	3-6	86139M	Type 2 Muffler, Round	3-8
19094N	Type 1 Muffler, Round.....	3-6	86144M	Type 1 Straight-Thru Resonator, Round	5-4
19141N	Type 5 Insulated Muffler, Round.....	3-16	86145M	Type 1 Straight-Thru Resonator, Round	5-4
20153T	Type 1 Muffler, Round	3-4	86147M	Type 2 Muffler, Oval.....	3-10
20154T	Type 1 Muffler, Oval.....	3-6	86148M	Type 7 Muffler, Round	3-18
20332A	Type 1 Muffler, Round.....	3-3	86149M	Type 5 Muffler, Oval.....	3-16
20445A	Type 7 Muffler, Oval.....	3-19	86150M	Type 1 Muffler, Round	5-4
20619T	Type 1 Muffler, Round.....	3-6	86151M	Type 7 Muffler, Round	3-18
20620T	Type 1 Muffler, Round.....	3-6	86152M	Type 7 Muffler, Round	3-18
20680T	Type 1 Muffler, Oval - JI Case.....	3-4	86153M	Type 2 Muffler, Oval.....	3-9
21317N	Type 1 Muffler, Round.....	3-6	86159M	Type 2 Muffler, Oval.....	3-8
21322N	Type 1 Muffler, Round.....	3-4	86164M	Type 2 Muffler, Round	3-8
21326A	Type 8 Muffler, Round	3-21	86168M	Type 2 Muffler, Round	3-9
22150T	Type 2 Muffler, Oval.....	3-9	86172M	Type 1 Muffler, Round	3-4
22152T	Type 2 Muffler, Oval.....	3-10	86173M	Type 1 Muffler, Round	3-4
22705T	Type 2 Muffler, Oval.....	3-11	86175M	Type 1 Muffler, Round	3-6
22706T	Type 1 Muffler, Round	3-3	86177M	Type 1 Muffler, Round	3-3
22794A	Type 7 Muffler, Oval.....	3-19	86178M	Type 1 Muffler, Round	3-4
23426N	Type 5 Muffler, Round	3-15	86180M	Type 2 Muffler, Oval.....	3-11
24050A	Type 7 Muffler, Round	3-19	86183M	Type 2A Muffler, Round	3-12
24051A	Type 7 Muffler, Round	3-19	86184M	Type 2A Muffler, Round.....	3-12
25582N	Type 5 Muffler, Round	3-15	86185M	Type 2A Muffler, Oval.....	3-12
25704N	Add-On Glass Packed Resonator	4-11	86186M	Type 1 Muffler, Round	3-3
25705N	Add-On Glass Packed Resonator.....	4-11	86187M	Type 1 Muffler, Round	3-4
25706N	Add-On Glass Packed Resonator.....	4-11	86188M	Type 1 Muffler, Round	3-4
25707N	Add-On Glass Packed Resonator.....	4-11	86189M	Type 1 Muffler, Round	3-5
25708N	Add-On Glass Packed Resonator.....	4-11	86190M	Type 5 Muffler, Round	3-15
25709N	Add-On Glass Packed Resonator.....	4-11	86191M	Type 5 Muffler, Round	3-15
25710N	Add-On Glass Packed Resonator.....	4-11	86192M	Type 5 Muffler, Round	3-15
25711N	Add-On Glass Packed Resonator.....	4-11	86193M	Type 5 Muffler, Oval.....	3-16
25922N	Type 5 Muffler, Round	3-16	86194M	Type 5 Muffler, Oval.....	3-17

Index

86195M	Type 1 Muffler, Round	3-7	86653M	Type 2 Muffler, Round	3-10
86196M	Type 1 Muffler, Round	3-7, 5-4	86655M	Type 7 Muffler, Round	3-20
86200M	Type 4 Muffler, Round	3-14	86656M	Type 1 Muffler, Round	3-7
86203M	Type 4 Muffler, Oval Double Wrapped	3-14	86664M	Type 2 Muffler, Oval (HD Version 86505M)	3-10
86206M	Type 2 Muffler, Oval Double Wrapped	3-8	86669M	Type 2 Muffler, Oval	3-9
86213M	Type 2 Muffler, Oval Double Wrapped	3-9	86672M	Type 7 Muffler, Round	3-19
86215M	Type 1 Muffler, Round Double Wrapped	3-5	86675M	Type 2 Muffler, Oval	3-8
86220M	Type 7 Muffler, Oval Double Wrapped	3-19	86682M	Type 1 Muffler, Round	3-7
86221M	Type 7 Muffler, Round Double Wrapped	3-19	86685M	Type 5 Muffler, Oval	3-17
86300M	Type 6A Wye Connector Muffler, Round	5-4	86690M	Type 1 Muffler, Round	3-4
86305M	Type 6 Splitter Tee Muffler, Round	5-4	86695M	Type 2A Muffler, Round	3-12
86402M	Type 1 Muffler 4, Round (Stainless 86102M)	5-4	86697M	Type 7 Muffler, Round	3-19
86408M	Type 1 Muffler 4, Round (Stainless 86108M)	5-4	86698M	Type 7 Muffler, Round	3-19
86430M	Type 1 Muffler, Round (Stainless 86130M)	5-4	86700M	Type 1 Muffler, Round - Stainless	5-4
86500M	Type 2 Muffler, Round	3-9	86704M	Type 7 Muffler, Oval	3-20
86501M	Type 7 Muffler, Round	3-19	86705M	Type 2 Muffler, Round	3-10
86502M	Type 2 Muffler, Round	3-9	86712M	Type 1 Muffler, Round - Stainless	5-4
86503M	Type 7 Muffler, Oval	3-19	86713M	Type 1 Muffler, Round	3-5
86504M	Type 2 Muffler, Oval	3-10	86722M	Type 2A Muffler, Round	3-12
86505M	Type 2 Muffler, Oval	3-9	86723M	Type 8 Muffler, Round	3-21
86506M	Type 2 Muffler, Oval	3-10	86724M	Type 5 Muffler, Round	3-16
86510M	Type 7 Muffler, Oval	3-18	86725M	Type 8 Muffler, Round	3-21
86511M	Type 7 Muffler, Oval	3-18	86727M	Type 8 Muffler, Round	3-21
86512M	Type 2 Muffler, Oval	3-9	86739M	Type 1 Muffler, Round	3-7
86513M	Type 7 Muffler, Oval	3-18	86740M	Type 1 Muffler, Round	3-5
86514M	Type 1 Muffler, Round	3-5	86744M	Type 1 Muffler, Round	3-4
86518M	Type 2 Muffler, Round Heavy Duty	3-8	86751M	Type 5 Muffler, Oval	3-16
86521M	Type 2 Muffler, Round Heavy Duty	3-8	86752M	Type 2 Muffler Oval	3-10
86522M	Type 2A Muffler, Round Heavy Duty	3-12	86753M	Type 2 Muffler Oval	3-10
86526M	Type 5 Muffler, Round	3-17	86754M	Type 7 Muffler, Oval	3-18
86529M	Type 2 Muffler, Round	3-9	86755M	Type 3 Muffler, Oval	3-13
86530M	Type 7 Muffler, Round	3-19	86756M	Type 8 Muffler, Round	3-21
86531M	Type 1 Muffler, Round	3-7	86757M	Type 5 Muffler, Oval	3-17
86533M	Type 1 Muffler, Round	3-7	86771M	Type 5 Muffler, Round	3-16
86535M	Type 1 Muffler, Round	3-5	86772M	Type 1 Muffler, Round	3-7
86536M	Type 2 Muffler, Oval	3-9	86773M	Type 1 Muffler, Round	3-6
86537M	Type 7 Muffler, Oval	3-18	86774M	Type 3 Muffler, Oval	3-13
86538M	Type 2A Muffler, Oval	3-12	86775M	Type 3 Muffler, Oval	3-13
86541M	Type 2 Muffler, Round	3-10	86776M	Type 1 Muffler, Round	3-7
86542M	Type 5 Muffler, Oval	3-16	86777M	Type 7 Muffler, Oval	3-18
86543M	Type 3 Muffler, Oval	3-13	86788M	Type 1 Muffler, Round	3-7
86544M	Type 1 Muffler, Round	3-5	89005C	Chrome Straight Stack Pipe	2-38
86545M	Type 7 Muffler, Oval	3-18	89006A	Aluminized Straight Stack Pipe	2-38
86547M	Type 1 Muffler, Round	3-5	89006C	Chrome Straight Stack Pipe	2-38
86548M	Type 7 Muffler, Oval	3-18	89014A	Aluminized Straight Stack Pipe	2-38
86556M	Type 1 Resonator, Round	5-4	89015A	Aluminized Straight Stack Pipe	2-38
86557M	Type 2A Muffler, Round	3-12	89016A	Aluminized Straight Stack Pipe	2-39
86560M	Type 1 Muffler, Round	3-5	89016C	Chrome Straight Stack Pipe	2-39
86561M	Type 1 Muffler, Round	3-5	89017A	Aluminized Straight Stack Pipe	2-39
86562M	Type 5 Muffler, Oval	3-16	89017C	Chrome Straight Stack Pipe	2-39
86570M	Type 5 Muffler, Oval	3-17	89018A	Aluminized Straight Stack Pipe	2-39
86582M	Aluminized Pak Stak	5-3	89019A	Aluminized Straight Stack Pipe	2-39
86597M	Type 7 Muffler, Oval	3-19	89019C	Chrome Plated Straight Stack Pipe	2-39
86598M	Type 5 Muffler, Oval	3-16	89020A	Aluminized Straight Stack Pipe, Slotted	2-38
86606M	Type 2 Muffler, Oval	3-10	89020C	Chrome Straight Stack Pipe, Slotted	2-38
86607M	Type 5 Muffler, Oval	3-16	89021A	Aluminized Straight Stack Pipe, Slotted	2-38
86608M	Type 7 Muffler, Oval	3-19	89021C	Chrome Straight Stack Pipe, Slotted	2-38
86610M	Type 1 Muffler, Round	3-7	89022A	Aluminized Straight Stack Pipe, Slotted	2-38
86624M	Type 1 Muffler, Round	3-7	89023A	Aluminized Straight Stack Pipe, Slotted	2-38
86626M	Type 1 Muffler, Round	3-7	89023C	Chrome Straight Stack Pipe, Slotted	2-38
86630M	Type 1 Muffler, Round (HD Version 86108M)	3-5	89024A	Aluminized Straight Stack Pipe, Slotted	2-38
86631M	Type 2 Muffler, Oval	3-9	89025A	Aluminized Straight Stack Pipe, Expanded & Notched	2-38
86644M	Type 2 Muffler, Round	3-10	89026A	Aluminized Straight Stack Pipe, Expanded & Notched	2-38

89026C	Chrome Straight Stack Pipe, Slotted	2-38	89086A	A/S Bend Ext Legs	2-20
89027A	Aluminized Straight Stack Pipe, Expanded & Notched.....	2-38	89087A	Aluminized 45° Elbow	2-20
89027C	Chrome Straight Stack Pipe, Slotted	2-38	89090A	Aluminized 90° Short Radius Elbow	2-23
89028A	Aluminized Straight Stack Pipe, Expanded & Notched.....	2-39	89091A	Aluminized 90° Short Radius Elbow	2-23
89029A	Aluminized Straight Stack Pipe, Expanded & Notched.....	2-39	89092A	Aluminized 90° Short Radius Elbow	2-23
89029C	Chrome Straight Stack Pipe, Slotted	2-39	89093A	Aluminized 90° Short Radius Elbow	2-23
89030A	Aluminized Straight Stack Pipe.....	2-39	89094A	Aluminized 90° Short Radius Elbow	2-23
89030C	Chrome Straight Stack Pipe, Slotted	2-39	89095A	Aluminized 90° Short Radius.....	2-23
89031A	Aluminized Straight Stack Pipe, Expanded & Notched.....	2-39	89096A	Aluminized 90° Short Radius Elbow	2-23
89031C	Chrome Plated Straight Stack Pipe, Expanded & Notched.....	2-39	89097A	Aluminized 90° Short Radius.....	2-23
89035A	Aluminized Curved Stack Pipe.....	2-38, 2-40	89098A	Aluminized 90° Elbow	2-24
89035C	Chrome Curved Stack Pipe.....	2-38, 2-40	89099A	Aluminized 90° Elbow	2-24
89036A	Aluminized Curved Stack Pipe.....	2-38, 2-40	89101A	Aluminized 90° Elbow	2-24
89036C	Chrome Curved Stack Pipe.....	2-38, 2-40	89102A	Aluminized 90° Elbow	2-24
89037A	Aluminized Curved Stack Pipe.....	2-38, 2-40	89103A	Aluminized 90° Elbow	2-24
89037C	Chrome Curved Stack Pipe.....	2-38, 2-40	89104A	Aluminized 90° Elbow	2-24
89040A	Aluminized Curved Stack Pipe.....	2-38, 2-40	89105A	Aluminized Steel 90° Bend - 10 legs.....	2-24
89041A	Aluminized Curved Stack Pipe.....	2-38, 2-40	89105C	Chrome Plated 90° Elbow.....	2-24
89042A	Aluminized Curved Stack Pipe.....	2-38, 2-40	89106A	Aluminized 90° Elbow	2-24
89043A	Aluminized Curved Stack Pipe.....	2-38, 2-40	89106C	Chrome Plated 90° Elbow.....	2-24
89043C	Chrome Curved Stack Pipe.....	2-38, 2-40	89107A	Aluminized Steel 90° Bend - 1 leg	2-25
89044A	Aluminized Curved Stack Pipe.....	2-38, 2-40	89107C	Chrome Plated 90° Elbow.....	2-25
89045A	Aluminized Curved Stack Pipe.....	2-38, 2-40	89108A	Aluminized 90° Elbow	2-25
89045C	Chrome Curved Stack Pipe.....	2-38, 2-40	89109A	Aluminized 90° Elbow	2-25
89046A	Aluminized Curved Stack Pipe.....	2-38, 2-40	89109C	Chrome 90° Elbow	2-25
89046C	Chrome Curved Stack Pipe.....	2-38, 2-40	89110A	Aluminized Steel Bend.....	2-22
89047A	Aluminized Curved Stack Pipe.....	2-38, 2-40	89111A	Aluminized 90° Elbow	2-22
89048A	Aluminized Curved Stack Pipe.....	2-38, 2-40	89113A	Aluminized 90° Elbow	2-22
89049A	Aluminized Curved Stack Pipe.....	2-38, 2-40	89114A	Aluminized 90° Elbow	2-22
89050A	Aluminized Curved Stack Pipe, Slotted.....	2-38, 2-40	89115A	Aluminized 90° Elbow	2-22
89050C	Chrome Plated Curved Stack Pipe, Expanded & Notched	2-38, 2-40	89115C	Chrome 90° Elbow	2-22
89051A	Aluminized Curved Stack Pipe, Slotted.....	2-38, 2-40, 2-41	89116A	Aluminized 90° Elbow	2-22
89051C	Chrome Plated Curved Stack Pipe, Expanded & Notched	2-38, 2-40	89117A	Aluminized 90° Elbow	2-22
89052A	Aluminized Curved Stack Pipe, Expanded & Notched	2-38, 2-40	89117C	Chrome Plated 90° Elbow.....	2-22
89052C	Chrome Curved Stack Pipe, Slotted.....	2-38, 2-40	89118A	Aluminized 90° Elbow	2-22
89053A	Aluminized Curved Stack Pipe.....	2-38, 2-40	89119A	Aluminized 90° Elbow	2-22
89053C	Chrome Curved Stack Pipe, Slotted.....	2-38, 2-40	89123A	Aluminized 90° Short Radius Elbow	2-23
89054A	Aluminized Curved Stack Pipe.....	2-38, 2-40	89124A	Aluminized 90° Short Radius.....	2-22
89054C	Chrome Plated Curved Stack Pipe, Expanded & Notched	2-38, 2-40	89125A	Aluminized 90° Elbow	2-22
89055A	Aluminized Steel Curved Stack Pipe, Expanded & Notched	2-38, 2-40	89126A	Aluminized Steel Bend.....	2-22
89055C	Chrome Plated Curved Stack Pipe, Expanded & Notched	2-38, 2-40	89127A	Aluminized 90° Elbow	2-22
89056A	Aluminized Steel Curved Stack Pipe, Expanded & Notched	2-38, 2-40	89130A	Aluminized 15° Elbow	2-20
89056C	Chrome Plated Curved Stack Pipe, Expanded & Notched	2-38, 2-40	89131A	Aluminized 15° Elbow	2-20
89057A	Aluminized Curved Stack Pipe, Expanded & Notched.....	2-38, 2-40	89132A	Aluminized 15° Short Radius Elbow	2-20
89057C	Chrome Plated Curved Pipe, Expanded & Notched.....	2-38, 2-40	89133A	Aluminized 15° Short Radius.....	2-20
89058A	Aluminized Steel Curved Stack Pipe, Expanded & Notched	2-39, 2-40	89140A	Aluminized Stack Pipe	2-40
89058C	Chrome Plated Curved Stack Pipe, Expanded & Notched	2-39, 2-40	89141A	Aluminized Tail Pipe.....	2-40
89059A	Aluminized Steel Curved Stack Pipe, Expanded & Notched	2-39, 2-40	89142A	Aluminized Curved Stack Pipe.....	2-40
89060A	Aluminized Steel Curved Stack Pipe, Expanded & Notched	2-39, 2-40	89143A	Aluminized Tail Pipe.....	2-40
89060C	Chrome Plated Curved Stack Pipe, Expanded & Notched	2-39, 2-40	89143C	Aluminized Curved Tail Pipe, Expanded & Notched	2-40
89071A	Aluminized 45° Elbow	2-20	89144A	Aluminized Curved Tail Pipe, Expanded & Notched	2-40
89073A	Aluminized 45° Elbow	2-20	89144C	Chrome Plated Tail Pipe.....	2-40
89074A	Aluminized 45° Elbow	2-20	89145A	Aluminized Curved Stack/Tail Pipe, Expanded & Notched	2-38, 2-40
89074C	Chrome 45° Elbow	2-20	89145C	Aluminized Curved Stack/Tail Pipe, Expanded & Notched	2-38, 2-40
89075A	Aluminized 45° Elbow	2-20	89146A	Aluminized Curved Stack/Tail Pipe, Expanded & Notched	2-39, 2-40
89075C	Chrome 45° Elbow	2-20	89146C	Aluminized Curved Stack/Tail Pipe, Expanded & Notched	2-39, 2-40
89076A	Aluminized 45° Elbow	2-20	89147A	Aluminized Tail Pipe.....	2-39, 2-40
89077A	Aluminized 45° Elbow	2-20	89147C	Chrome Tail Pipe	2-40
89081A	Aluminized 45° Elbow	2-20	89150A	Aluminized Curved Stack Pipe.....	2-40
89082A	Aluminized 45° Elbow	2-20	89151A	Aluminized Tail Pipe.....	2-40
89083A	Aluminized 45° Elbow	2-20	89152A	Aluminized Curved Stack Pipe.....	2-40
89084A	A/S Bend Ext Legs	2-20	89153A	Aluminized Tail Pipe.....	2-40
89085A	A/S Bend Ext Legs	2-20	89154A	Aluminized Tail Pipe.....	2-40

Index

89155A	Aluminized Tail Pipe.....	2-38, 2-40	89236A	Aluminized 90° Short Radius Elbow.....	2-23
89155C	Chrome Plated Tail Pipe.....	2-38, 2-40	89237A	Aluminized 70° Elbow.....	2-21
89156A	Aluminized Tail Pipe.....	2-39, 2-40	89238A	Aluminized 70° Elbow.....	2-21
89156C	Chrome Plated Tail Pipe.....	2-39, 2-40	89239A	Aluminized 70° Elbow.....	2-21
89157A	Aluminized Curved Stack Pipe.....	2-39, 2-40	89240A	Aluminized 45° Elbow.....	2-20
89160A	Coupler Aluminized Steel Tube.....	2-12	89241A	Aluminized 45° Elbow.....	2-20
89161A	Coupler Aluminized Steel Tube.....	2-12	89242A	Aluminized 45° Elbow.....	2-20
89162A	Coupler Aluminized Steel Tube.....	2-12	89243A	Aluminized 45° Elbow.....	2-20
89163A	Coupler Aluminized Steel Tube.....	2-12	89246A	Straight Connector.....	2-12
89164A	Coupler Aluminized Steel Tube.....	2-12	89247A	Straight Connector.....	2-12
89165A	Straight Connector.....	2-12	89248A	Straight Connector.....	2-12
89166A	Coupler Aluminized Steel Tube.....	2-12	89249A	Straight Connector.....	2-12
89167A	Coupler Aluminized Steel Tube.....	2-12	89250A	Straight Connector.....	2-12
89168A	Reducer.....	2-12	89251A	Straight Connector.....	2-12
89170A	Reducer.....	2-12	89252A	Straight Connector.....	2-12
89172A	Reducer.....	2-12	89253A	Reducer.....	2-12
89173A	Reducer.....	2-12	89254A	Reducer.....	2-12
89182A	Reducer.....	2-12	89255A	Reducer.....	2-12
89184A	Reducer.....	2-12	89256A	Reducer.....	2-12
89185A	Reducer.....	2-12	89261A	Straight Connector.....	2-12
89186A	Reducer.....	2-12	89263A	Straight Connector.....	2-12
89187A	Reducer.....	2-12	89266A	Straight Connector.....	2-12
89193U	Aluminized Pak Stak.....	5-3	89271A	Reducer.....	2-12
89194U	Aluminized Pak Stak.....	5-3	89274A	Reducer.....	2-12
89195U	Aluminized Pak Stak.....	5-3	89275A	Reducer.....	2-12
89196U	Aluminized Pak Stak.....	5-3	89276A	Reducer.....	2-12
89197U	Polished Stainless Pak Stak.....	5-3	89277A	Reducer.....	2-12
89198U	Polished Stainless Pak Stak.....	5-3	89278A	Reducer.....	2-12
89205A	Aluminized Straight Stack Pipe.....	2-38	89279A	Reducer.....	2-12
89211A	Aluminized Straight Stack Pipe, Slotted.....	2-38	89282A	Reducer.....	2-12
89212A	Aluminized Straight Stack Pipe, Slotted.....	2-38	89283A	Reducer.....	2-12
89213A	Aluminized Straight Stack Pipe, Slotted.....	2-38	89285A	Aluminized Curved Stack Pipe.....	2-40
89214A	Aluminized Straight Stack Pipe, Slotted.....	2-38	89293A	Aluminized Curved Stack Pipe.....	2-38
89215A	Aluminized Straight Stack Pipe, Slotted.....	2-38	89293C	Chrome Plated Curved Stack Pipe.....	2-38
89216A	Aluminized Straight Stack Pipe, Expanded & Notched.....	2-38	89294C	Chrome Plated Curved Stack Pipe.....	2-38
89217A	Aluminized Straight Stack Pipe, Expanded & Notched.....	2-38	89295C	Chrome Plated Curved Stack Pipe.....	2-38
89217C	Chrome Straight Stack Pipe, Slotted.....	2-38	89296A	Aluminized Curved Stack Pipe.....	2-39
89218A	Aluminized Straight Stack Pipe, Expanded & Notched.....	2-39	89296C	Chrome Plated Curved Stack Pipe.....	2-39
89218C	Chrome Plated Straight Stack Pipe, Expanded & Notched.....	2-39	89298C	Chrome Plated Curved Stack Pipe.....	2-39
89219A	Aluminized Straight Stack Pipe, Slotted.....	2-39	89309K	Aluminized Flex Tubing, Cut to Length.....	2-18
89221A	Aluminized Curved Stack Pipe.....	2-38, 2-40	89310K	Aluminized Flex Tubing, Cut to Length.....	2-18
89221C	Chrome Curved Stack Pipe.....	2-38, 2-40	89311K	Aluminized Flex Tubing, Cut to Length.....	2-18
89222A	Aluminized Steel Curved Stack Pipe.....	2-38, 2-40	89313K	Aluminized Flex Tubing, Cut to Length.....	2-18
89222C	Chrome Plated Curved Stack Pipe.....	2-38, 2-40	89314K	Aluminized Flex Tubing, Cut to Length.....	2-18
89223A	Aluminized Curved Stack Pipe, Slotted.....	2-39, 2-40	89417A	Aluminized Rain Cap.....	2-47
89223C	Chrome Curved Stack Pipe, Slotted.....	2-39, 2-40	89420A	Aluminized Rain Cap.....	2-47
89224A	Aluminized Curved Stack Pipe.....	2-39, 2-40	89422A	Aluminized Rain Cap.....	2-47
89224C	Chrome Curved Stack Pipe, Slotted.....	2-39, 2-40	89425A	Aluminized Rain Cap.....	2-47
89225A	Aluminized Curved Stack Pipe.....	2-38, 2-40	89427A	Aluminized Rain Cap.....	2-47
89225C	Chrome Curved Stack Pipe, Slotted.....	2-38, 2-40	89430E	Silent Rain Cap.....	2-47
89226A	Aluminized Curved Stack Pipe, Slotted.....	2-38, 2-40	89435A	Aluminized Rain Cap.....	2-47
89226C	Chrome Plated Curved Stack Pipe, Expanded & Notched.....	2-38, 2-40	89435E	Silent Rain Cap.....	2-47
89227A	Aluminized Steel Curved Stack Pipe, Expanded & Notched.....	2-39, 2-40	89440A	Aluminized Rain Cap.....	2-47
89227C	Aluminized Steel Curved Stack Pipe, Expanded & Notched.....	2-39, 2-40	89440C	Chrome Rain Cap.....	2-47
89228A	Aluminized Curved Stack Pipe.....	2-39, 2-40	89440E	Silent Aluminized Rain Cap.....	2-47
89228C	Chrome Plated Curved Stack Pipe.....	2-39, 2-40	89445A	Aluminized Rain Cap.....	2-47
89229A	Aluminized Curved Stack Pipe.....	2-39, 2-40	89450A	Aluminized Rain Cap.....	2-47
89230A	Aluminized 90° Elbow.....	2-24	89450C	Chrome Rain Cap.....	2-47
89231A	Aluminized 90° Elbow.....	2-22	89450E	Silent Aluminized Rain Cap.....	2-47
89232A	Aluminized 90° Elbow.....	2-24	89460A	Aluminized Rain Cap.....	2-47
89233A	Aluminized 90° Elbow.....	2-22	89460C	Chrome Rain Cap.....	2-47
89234A	Aluminized 90° Elbow.....	2-22	89500K	V-Band Clamp.....	2-8
89235A	Aluminized 90° Elbow.....	2-22	89501K	V-Band Clamp, Cummins (VT555).....	2-8, 2-10, 2-16

89502K	V-Band Clamp.....	2-9	89566K	Chrome Plated Flat U-Bolt Pipe Clamp	2-4
89503K	V-Band Clamp, Cummins (T50-VT50 M11)	2-9, 2-11, 2-14	89568K	Chrome Plated Flat U-Bolt Pipe Clamp	2-4
89505K	V-Band Clamp, Detroit (6V53-71)	2-8, 2-10, 2-11	89569K	Chrome Plated Flat U-Bolt Pipe Clamp	2-4
89506K	V-Band Clamp, Detroit (8V71-671)	2-8, 2-10	89570K	Chrome Plated Flat U-Bolt Pipe Clamp	2-4
89507K	V-Band Clamp, Detroit (6V71)	2-8, 2-10	89571K	V-Band Clamp, Cummins B	2-8, 2-11
89508K	V-Band Clamp.....	2-8	89573K	V-Band Clamp, Cummins C	2-8
89509K	V-Band Clamp (2T 2295978).....	2-8, 2-11	89600K	Galvanized Flex Tubing, Cut to Length.....	2-18
89510K	V-Band Clamp, Detroit (8V71T 6V92T 8V92T).....	2-9, 2-10	89601K	Galvanized Flex Tubing, Cut to Length.....	2-18
89511K	V-Band Clamp.....	2-9, 2-10	89602K	Galvanized Flex Tubing, Cut to Length.....	2-18
89512K	V-Band Clamp, IH DT466.....	2-8, 2-11, 2-14	89603K	Galvanized Flex Tubing, Cut to Length.....	2-18
89513K	V-Band Clamp, Connector Ends.....	2-9, 2-10, 2-11, 2-14	89604K	Galvanized Flex Tubing, Cut to Length.....	2-18
89514K	V-Band Clamp, Connector Ends.....	2-9, 2-10, 2-11	89605K	Galvanized Flex Tubing, Cut to Length.....	2-18
89518K	Universal Mounting Bracket	2-45	89606K	Galvanized Flex Tubing, Cut to Length.....	2-18
89519K	Universal Muffler Hanger, Swivel	2-46	89607K	Galvanized Flex Tubing, Cut to Length.....	2-18
89520K	V-Band Clamp (L10 M11 3126T 3176T).....	2-8	89608K	Galvanized Flex Tubing, Cut to Length.....	2-18
89521K	EasySeal™ Stainless Steel Flat Band Clamp	2-6	89609K	Galvanized Flex Tubing, Cut to Length.....	2-18
89522K	EasySeal Stainless Steel Flat Band Clamp	2-6	89611K	Galvanized Flex Tubing, Cut to Length.....	2-18
89523K	EasySeal Stainless Steel Flat Band Clamp	2-6	89612K	Stainless Steel Flex Tubing, Cut to Length.....	2-18
89524K	EasySeal Stainless Steel Flat Band Clamp	2-6	89613K	Stainless Steel Flex Tubing, Cut to Length.....	2-18
89525B	EasySeal Stainless Steel Flat Band Clamp (Bulk 40 pack)	2-6	89614K	Stainless Steel Flex Tubing, Cut to Length.....	2-18
89525K	EasySeal Stainless Steel Flat Band Clamp	2-6	89615K	Stainless Steel Flex Tubing, Cut to Length.....	2-18
89525W	Stainless Steel Flat Band Clamp	2-5	89616K	Stainless Steel Flex Tubing, Cut to Length.....	2-18
89526B	EasySeal Stainless Steel Flat Band Clamp (Bulk 40 pack)	2-6	89617K	Stainless Steel Flex Tubing, Cut to Length.....	2-18
89526K	EasySeal™ Stainless Steel Flat Band Clamp	2-6	89618K	Stainless Steel Flex Tubing, Cut to Length.....	2-18
89526W	Stainless Steel Flat Band Clamp	2-5	89619K	Stainless Steel Flex Tubing, Cut to Length.....	2-18
89527B	EasySeal Stainless Steel Flat Band Clamp (Bulk 40 pack)	2-6	89620K	Stainless Steel Roll Bulk Flex Tubing	2-19
89527K	Stainless Steel EasySeal Flat Band Clamp	2-6	89621K	Stainless Steel Roll Bulk Flex Tubing	2-19
89527W	Stainless Steel Flat Band Clamp	2-5	89622K	Stainless Steel Roll Bulk Flex Tubing	2-19
89528B	EasySeal Stainless Steel Flat Band Clamp (Bulk 50 pack)	2-6	89623K	Stainless Steel Roll Bulk Flex Tubing	2-19
89528K	EasySeal Stainless Steel Flat Band Clamp - 10 Pack Assembled	2-6	89624K	Stainless Steel Roll Bulk Flex Tubing	2-19
89528W	Stainless Steel Flat Band Clamp	2-5	89624P	Stainless PolyLock™ Flex Tubing.....	2-19
89529K	EasySeal Stainless Steel Flat Band Clamp	2-6	89625K	Stainless Steel Roll Bulk Flex Tubing	2-19
89530K	V-Band Clamp.....	2-8	89625P	Polylok Stainless Steel Roll Bulk Flex Tubing.....	2-19
89531K	V-Band Clamp, Cat 3208T, Ford 6 8 E2HT5A212AA.....	2-8, 2-11	89626K	Stainless Steel Roll Bulk Flex Tubing	2-19
89532K	V-Band Clamp.....	2-8	89640K	Galvanized Roll Bulk Flex Tubing	2-19
89533K	V-Band Clamp, Mack 48RU2341	2-9	89641K	Galvanized Roll Bulk Flex Tubing	2-19
89535K	Universal Muffler Hanger.....	2-46	89642K	Galvanized Roll Bulk Flex Tubing	2-19
89536K	Universal Muffler Hanger.....	2-46	89643K	Galvanized Roll Bulk Flex Tubing	2-19
89537K	Universal Muffler Hanger.....	2-46	89644K	Galvanized Roll Bulk Flex Tubing	2-19
89538K	Universal Muffler Hanger.....	2-46	89645K	Galvanized Roll Bulk Flex Tubing	2-19
89539K	Universal Muffler Hanger.....	2-46	89646K	Galvanized Roll Bulk Flex Tubing	2-19
89540K	Universal Muffler Hanger.....	2-46	89647K	Galvanized Flex Tubing	2-19
89541K	Zinc Plated Guillotine U-Bolt Pipe Clamp	2-4	89648K	Galvanized Flex Tubing	2-19
89542K	Zinc Plated Guillotine U-Bolt Pipe Clamp	2-4	89701K	Aluminized Flex Tubing, Cut to Length.....	2-18
89543K	Zinc Plated Guillotine U-Bolt Pipe Clamp	2-4	89708K	Galvanized Steel Bulk Flex Tubing.....	2-19
89544K	Zinc Plated Guillotine U-Bolt Pipe Clamp.....	2-4	89709K	Galvanized Steel Bulk Flex Tubing	2-19
89545K	Zinc Plated Guillotine U-Bolt Pipe Clamp	2-4	89710K	Galvanized Steel Bulk Flex Tubing.....	2-19
89546K	Zinc Plated Guillotine U-Bolt Pipe Clamp	2-4	89712K	Galvanized Steel Bulk Flex Tubing.....	2-19
89547K	Zinc Plated Guillotine U-Bolt Pipe Clamp	2-4	89713K	Galvanized Steel Bulk Flex Tubing.....	2-19
89548C	Chrome Plated Guillotine U-Bolt Pipe Clamp	2-4	89714K	Galvanized Steel Bulk Flex Tubing.....	2-19
89548K	Zinc Plated Guillotine U-Bolt Pipe Clamp	2-4	89715K	Galvanized Steel Bulk Flex Tubing.....	2-19
89549C	Chrome Plated Guillotine U-Bolt Pipe Clamp	2-4	89716K	Galvanized Steel Bulk Flex Tubing	2-19
89549K	Zinc Plated Guillotine U-Bolt Pipe Clamp	2-4	89719K	Stainless Steel Bulk Flex Tubing	2-19
89550C	Chrome Plated Guillotine U-Bolt Pipe Clamp	2-4	89721K	Stainless Steel Bulk Flex Tubing	2-19
89550K	Zinc Plated Guillotine U-Bolt Pipe Clamp	2-4	89722K	Stainless Steel Bulk Flex Tubing	2-19
89551K	Universal Muffler Hanger.....	2-46	89723K	Stainless Steel Bulk Flex Tubing	2-19
89556K	Zinc Plated Flat U-Bolt Pipe Clamp	2-4	89723P	Polylok Stainless Steel Bulk Flex Tubing.....	2-19
89557K	Zinc Plated Flat U-Bolt Pipe Clamp	2-4	89724K	Stainless Steel Bulk Flex Tubing	2-19
89558B	Zinc Plated Flat U-Bolt Pipe Clamp (Bulk 50 pack)	2-4	89724P	Polylok Stainless Steel Bulk Flex Tubing.....	2-19
89558K	Zinc Plated Flat U-Bolt Pipe Clamp	2-4	89725K	Stainless Steel Bulk Flex Tubing	2-19
89559B	Zinc Plated Flat U-Bolt Pipe Clamp (Bulk 50 pack)	2-4	89727K	Stainless Steel Flex Tubing, Cut to Length.....	2-18
89559K	Zinc Plated Flat U-Bolt Pipe Clamp	2-4	89728K	Stainless Steel Flex Tubing, Cut to Length.....	2-18
89560K	Zinc Plated Flat U-Bolt Pipe Clamp	2-4	89729K	Stainless Steel Flex Tubing, Cut to Length.....	2-18

Index

89730K	Stainless Steel Flex Tubing, Cut to Length	2-18	89926A	Aluminized 90° Short Radius Elbow	2-23
89731K	Stainless Steel Flex Tubing, Cut to Length	2-18	89940A	Aluminized Splitter Tee Adapter Pipe	2-28
89733K	Stainless Steel Flex Tubing, Cut to Length	2-18	89941A	Conventional Wye Pipe	2-28
89740K	Aluminized Flex Connector	2-14	89942A	Conventional Wye Pipe	2-28
89742K	Aluminized Flex Connector	2-14	89950A	Aluminized Splitter Tee Adapter Pipe	2-28
89744C	Heat Guard, Stainless Steel 1/2 Wrap	2-43	89950C	Chrome Splitter Tee Adapter Pipe	2-28
89744F	Heat Guard, Stainless Steel 1/2 Wrap	2-43	89951A	Conventional Wye Pipe	2-28
89745C	Heat Guard, Stainless Steel 1/2 Wrap	2-43	89955K	Flared Connector	2-10
89748A	Heat Guard, Stainless Steel 1/2 Wrap	2-43	89956K	Flared Connector	2-10
89749C	Heat Guard, Stainless Steel 1/2 Wrap	2-43	89958K	Flared Connector	2-10
89759K	Aluminized Length Flex Tubing	2-19	89959K	Flared Connector	2-10
89760K	Aluminized 25' Flex Tubing	2-19	89960K	Flared Connector	2-10
89761K	Clamp Kit - Includes 2 Clamps	2-47	89961K	Flared Connector	2-10
89762K	Mounting Clamp Kit, 1/2 Wrap (2 per kit)	2-47	89962K	Flared Connector, Cat 3208 (use clamp 89531K)	2-11
89763K	Mounting Clamp Kit, 1/2 Wrap (2 per kit)	2-47	89963K	Flared Connector	2-11
89766K	Mounting Clamp Kit, 3/4 Wrap (2 per kit)	2-47	89964K	Flared Connector, DD 2L Turbo/Cat 3126T (use clamp 89509K)	2-11
89767K	Mounting Clamp Kit, 3/4 Wrap (2 per kit)	2-47	89965K	Flared Connector, Cummins L10 (use clamp 89513K)	2-11
89771K	Mounting Clamp Kit, 1/2 Wrap (2 per kit)	2-47	89966K	Flared Connector, Cummins (use clamp 89514K)	2-11
89772K	Aluminized Steel Bulk Flex Tubing	2-19	89967K	Flared Connector, Cummins M11 (use clamp 89503K)	2-11
89773K	Aluminized Steel Bulk Flex Tubing	2-19	89971K	Flared Connector	2-10
89774C	Heat Guard, Stainless Steel 3/4 Wrap	2-43	89985A	Aluminized Curved Stack Pipe, Slotted	2-38
89775K	Universal Grab Handle	2-47	89985C	Chrome Plated Curved Stack Pipe, Expanded & Notched	2-38
89780A	Aluminized 45° Elbow	2-20	89986C	Chrome Plated Curved Stack Pipe, Expanded & Notched	2-38
89780C	Chrome 45° Elbow	2-20	89987C	Chrome Plated Curved Stack Pipe, Expanded & Notched	2-38
89781C	Chrome 45° Elbow	2-20	89988C	Chrome Plated Curved Stack Pipe, Expanded & Notched	2-39
89782A	Aluminized 45° Elbow	2-20	89989C	Chrome Plated Curved Stack Pipe, Expanded & Notched	2-39
89783A	Aluminized 45° Elbow	2-20	89990C	Chrome Plated Curved Stack Pipe, Expanded & Notched	2-39
89784A	Aluminized 90° Elbow	2-25	89993C	Chrome Plated Miter Cut Stack Pipe	2-39
89784C	Chrome 90° Elbow	2-25	89994C	Chrome Plated Miter Cut Stack Pipe	2-39
89786K	Stainless Bellows Connector	2-14	89995C	Heat Guard, Stainless Steel 3/4 Wrap	2-43
89787K	Stainless Bellows Connector	2-14	89996C	Heat Guard, Stainless Steel 1/2 Wrap	2-43
89788K	Stainless Bellows Connector	2-14	89997C	Chrome Plated Curved Stack Pipe	2-39
89789K	Stainless Bellows Connector	2-14	89999C	Chrome Curved Stack Pipe	2-39
89790K	Stainless Bellows Connector	2-14	90076A	Universal Pipe Hanger	2-46
89791K	Stainless Bellows Connector	2-14	90079A	Universal Pipe Hanger	2-46
89792K	Stainless Bellows Connector	2-14	90080A	Universal Pipe Hanger	2-46
89794K	Stainless Bellows Connector	2-14	90081A	Special Peterbilt Turbo Elbow	2-36
89796K	Stainless Bellows Connector	2-14	90082A	Special Peterbilt 90° Elbow	2-25, 2-36
89797K	Stainless Bellows Connector	2-14	90083A	Special Navistar Turbo Elbow	2-34
89798K	Stainless Bellows Connector	2-14	90092A	Zinc Plated Guillotine U-Bolt Pipe Clamp	2-4
89880A	Exhaust Pipe	2-33	90191K	Aluminized Flex Tubing	2-19
89881A	Reducer	2-12	90206K	Aluminized Flex Tubing	2-19
89882A	Special Navistar Tube	2-34	90289C	Chrome Light Deflector	2-48
89883A	Reducer	2-12	90290C	Chrome Light Deflector	2-48
89887A	Special Mack Tube	2-36	90350A	Aluminized Lap TorcTite™ Clamp	2-7
89889A	Special Navistar Turbo Elbow	2-34	90352A	Aluminized Steel TorcTite Lap Clamp	2-7
89892A	Special Navistar Turbo Elbow	2-34	90352B	Aluminized Steel TorcTite Lap Clamp (50 pack unassembled)	2-7
89893A	Special Navistar Vertical Stack Pipe	2-32	90353A	Aluminized Steel TorcTite Lap Clamp	2-7
89897A	Special Mack Tube	2-36	90354A	Aluminized Steel TorcTite Lap Clamp	2-7
89899A	Dump Truck Stack Pipe	2-41	90355A	Aluminized Steel TorcTite Lap Clamp - Retail Box	2-7
89901A	Aluminized Special Kenworth Elbow	2-35	90356B	Aluminized Steel TorcTite Lap Clamp (50 pack unassembled)	2-7
89906C	Chrome Stack Pipe	2-38	90357A	Aluminized Lap TorcTite Clamp	2-7
89916A	Aluminized Straight Stack Pipe	2-38	90358A	Aluminized Steel TorcTite Lap Clamp - Retail Box	2-7
89916C	Chrome Straight Stack Pipe	2-38	90358B	Aluminized Steel TorcTite Lap Clamp (50 pack unassembled)	2-7
89918C	Chrome Straight Stack Pipe	2-39	90359A	Aluminized TorcTite Lap Clamp	2-7
89920A	Aluminized Straight Stack Pipe, Slotted	2-39	90359B	Aluminized TorcTite Lap Clamp (50 pack unassembled)	2-7
89920C	Chrome Straight Stack Pipe, Slotted	2-39	90361A	Stainless Lap TorcTite Clamp	2-7
89921C	Chrome Plated Miter Cut Stack Pipe	2-38	90363A	Stainless Steel TorcTite Lap Clamp	2-7
89923A	Aluminized 90° Elbow	2-24	90364A	Stainless Lap TorcTite Clamp - Retail Box	2-7
89923C	Chrome 90° Elbow	2-24	90364B	Stainless Steel TorcTite Lap Clamp (50 pack unassembled)	2-7
89924A	Aluminized 90° Elbow	2-25	90365A	Stainless Steel TorcTite Lap Clamp	2-7
89924C	Chrome 90° Elbow	2-25	90365B	Stainless Steel TorcTite Lap Clamp (50 pack unassembled)	2-7
89925A	Aluminized 90° Short Radius Elbow	2-23	90366B	Stainless Steel TorcTite Lap Clamp (50 pack unassembled)	2-7

90367A	Stainless Lap TorcTite Clamp.....	2-7	90568C	Chrome Plated "Monster" Stack.....	2-42
90368A	Stainless Steel TorcTite Lap Clamp - Retail Box.....	2-7	90569A	Flared Adapter.....	2-11
90368B	Stainless Steel TorcTite Lap Clamp (50 pack unassembled).....	2-7	90570C	Chrome Plated "Monster" Stack.....	2-42
90369A	Stainless Steel TorcTite Butt Clamp.....	2-7	90571C	Chrome Plated "Monster" Stack.....	2-42
90374A	Aluminized TorcTite Butt Clamp - Retail Box.....	2-7	90572A	Connector.....	2-11
90374B	Aluminized TorcTite Butt Clamp (50 pack unassembled).....	2-7	90573A	Connector.....	2-11
90375A	Aluminized TorcTite Butt Clamp - Retail Box.....	2-7	90575A	Connector.....	2-11
90375B	Aluminized TorcTite Butt Clamp (50 pack unassembled).....	2-7	90576C	Chrome Plated "Monster" Stack.....	2-42
90376A	Aluminized TorcTite Butt Clamp - Retail Box.....	2-7	90577C	Chrome Plated "Monster" Stack.....	2-42
90378A	Aluminized TorcTite Butt Clamp - Retail Box.....	2-7	90578C	Chrome Plated "Monster" Stack.....	2-42
90378B	Aluminized TorcTite Butt Clamp (50 pack unassembled).....	2-7	90579C	Chrome Plated "Monster" Stack.....	2-42
90379A	Aluminized Butt TorcTite Clamp - Retail Box.....	2-7	90587K	Exhaust Elbow/Pipe Shield.....	2-48
90382A	Stainless Butt TorcTite Clamp - Retail Box.....	2-7	90589C	Mitered Chrome Stack Pipe.....	2-39
90384A	Stainless Steel TorcTite Butt Clamp - Retail Box.....	2-7	90591C	Mitered Chrome Stack Pipe.....	2-39
90385A	Stainless Butt TorcTite Clamp - Retail Box.....	2-7	90595C	Mitered Chrome Stack Pipe.....	2-38
90386A	Stainless Steel TorcTite Butt Clamp - Retail Box.....	2-7	90597C	Mitered Chrome Stack Pipe.....	2-39
90386B	Stainless Steel TorcTite Butt Clamp (50 pack unassembled).....	2-7	90598C	Stack Support Bracket for "Monster" Stacks.....	2-45
90387A	Stainless Butt TorcTite Clamp - Retail Box.....	2-7	90604C	Mitered Chrome Stack Pipe.....	2-39
90388A	Stainless Steel TorcTite Butt Clamp - Retail Box.....	2-7	90605C	Chrome Straight Stack Pipe.....	2-39
90388B	Stainless Steel TorcTite Butt Clamp (50 pack unassembled).....	2-7	90608C	Chrome Straight Stack Pipe.....	2-39
90389A	Stainless Butt TorcTite Clamp - Retail Box.....	2-7	90610C	Chrome Straight Stack Pipe.....	2-39
90438C	Chrome Plated Mitered Cut Stack Pipe.....	2-39	90612C	Chrome Straight Stack Pipe.....	2-39
90439C	Chrome Mitered West Coast Stack Pipe.....	2-39	90613C	Chrome Straight Stack Pipe.....	2-39
90440C	Chrome Mitered West Coast Stack Pipe.....	2-39	90614C	Chrome Curved Stack Pipe.....	2-39
90441C	Chrome Mitered West Coast Stack Pipe.....	2-39	90822A	Aluminized 90° Short Radius Elbow.....	2-23
90442C	Chrome Mitered West Coast Stack Pipe.....	2-39	90823A	Special Navistar Turbo Elbow.....	2-34
90443A	90° Curved Stack Pipe.....	2-41	90842C	Chrome Plated "Monster" Stack.....	2-42
90444A	90° Curved Stack Pipe.....	2-41	90843K	Universal Swivel Hanger.....	2-46
90444C	90° Chrome Curved Stack Pipe.....	2-41	90847A	Aluminized 90° Elbow.....	2-24
90447C	Chrome Plated "Monster" Stack.....	2-42	90847C	Chrome 90° Elbow.....	2-24
90448C	Chrome Plated "Monster" Stack.....	2-42	90854A	Tube Connector Flange.....	2-11
90449C	Chrome Plated "Monster" Stack.....	2-42	90856C	Heat Guard, Stainless Steel 1/2 Wrap.....	2-43
90450C	Chrome Plated "Monster" Stack.....	2-42	90857K	Clamp Kit (2 per kit).....	2-47
90451A	Aluminized Dump Truck Stack Pipe.....	2-41	90859A	Aluminized 90° Elbow.....	2-25
90451C	Chrome Dump Truck Stack Pipe.....	2-41	90859C	90° Chrome Elbow, Expanded & Notched.....	2-25
90452A	Aluminized Dump Truck Stack Pipe.....	2-41	90863K	Universal Swivel Hanger.....	2-46
90452C	Chrome Dump Truck Stack Pipe.....	2-41	90866A	Welded Saddle U-Bolt Clamp.....	2-4
90453K	Connector.....	2-14	90867A	Welded Saddle U-Bolt Clamp.....	2-4
90455C	90° Chrome Plated Short Radius Elbow.....	2-23	90868A	Welded Saddle U-Bolt Clamp.....	2-4
90459A	Aluminized 90° Elbow.....	2-24	90869A	Aluminized AccuSeal™ Clamp.....	2-5
90460A	Aluminized 90° Elbow.....	2-25	90870A	Aluminized AccuSeal Clamp.....	2-5
90461C	Heat Guard, Stainless Steel 3/4 Wrap.....	2-43	90872A	Aluminized AccuSeal Band Clamp.....	2-5
90464K	Stainless Steel EasySeal™ Flat Band Clamp.....	2-6	90873A	Aluminized Steel AccuSeal Single Bolt Pipe Clamp.....	2-5
90465A	Aluminized 67° Elbow.....	2-21, 2-36	90874A	Aluminized Steel AccuSeal Single Bolt Pipe Clamp.....	2-5
90465C	Chrome Plated 67° Elbow.....	2-21, 2-36	90875A	Aluminized Steel AccuSeal Single Bolt Pipe Clamp.....	2-5
90470K	Threaded Adapter.....	2-13	90876A	Aluminized AccuSeal Band Clamp.....	2-5
90488A	Aluminized 45° Elbow.....	2-20	90877A	Aluminized Steel AccuSeal Single Bolt Pipe Clamp.....	2-5
90526C	Chrome Plated Curved Stack Pipe, Expanded & Notched.....	2-39	90878A	Aluminized Steel AccuSeal Single Bolt Pipe Clamp.....	2-5
90531K	V-Band Clamp, DD 8V71.....	2-9	90885A	Stainless Steel AccuSeal Single Bolt Pipe Clamp.....	2-5
90533A	Tilt Cab Connector.....	2-13	90887A	Stainless Steel AccuSeal Single Bolt Pipe Clamp.....	2-5
90534A	Tilt Cab Connector.....	2-13	90889A	Aluminized 90° Elbow.....	2-23
90537A	Tilt Cab Connector.....	2-13	90891K	Tube Connector Kit.....	2-14
90538A	Tilt Cab Connector.....	2-13	90892K	Tube Connector Kit.....	2-14
90539A	Tilt Cab Connector.....	2-13	90893K	Tube Connector Kit.....	2-14
90546K	Polished TorcTite™ Lap Clamp.....	2-7	90895U	Chrome Pak Stak.....	5-3
90547K	Polished Stainless Lap TorcTite Clamp - Retail Box.....	2-7	90900K	,360° Muffler Guard Clamp Kit (2 per kit).....	2-45
90552A	Aluminized Straight Stack Pipe, Slotted.....	2-38	90901C	,360° Stainless Muffler Guard - Slot Pattern.....	2-43
90555C	Heat Guard, Stainless Steel 3/4 Wrap.....	2-43	90902K	Galvanized Flex Tubing, Cut to Length.....	2-18
90556C	Heat Guard, Stainless Steel 3/4 Wrap.....	2-43	90903K	Galvanized Flex Tubing, Cut to Length.....	2-18
90560A	Reducer.....	2-12	90904A	Aluminized Straight Stack Pipe, Slotted.....	2-39
90562A	Aluminized 90° Elbow.....	2-24	90905C	Chrome Plated "Monster" Stack.....	2-42
90563A	Aluminized Slotted Curved Stack/Tail Pipe.....	2-38, 2-40	90906A	Aluminized Straight Stack Pipe, Expanded & Notched.....	2-38
90567A	Adapter.....	2-11	90907K	Exhaust Pipe Expander.....	2-28

Index

90909A	Aluminized Curved Tail Pipe, Expanded & Notched	2-40	201844N	Type 5 Off-Highway Industrial Muffler, Round	4-6
90909C	Aluminized Curved Tail Pipe, Expanded & Notched	2-40	201845N	Type 2 Off-Highway Industrial Muffler, Round	4-4
90910A	Aluminized Curved Tail Pipe, Expanded & Notched	2-40	201846N	Type 8 Off-Highway Industrial Muffler, Round	4-8
90910C	Chrome Slotted Curved Stack/Tail Pipe, Expanded & Notched	2-40	201847N	Type 5 Off-Highway Industrial Muffler, Round	4-6
90913A	Aluminized Tail Pipe	2-40	201848N	Type 2 Off-Highway Industrial Muffler, Round	4-4
90914K	U-Bolt Clamp	2-4	201849N	Type 8 Off-Highway Industrial Muffler, Round	4-8
90915K	U-Bolt Clamp	2-4	201850N	Type 5 Off-Highway Industrial Muffler, Round	4-6
90916K	U-Bolt Clamp	2-4	201851N	Type 2 Off-Highway Industrial Muffler, Round	4-4
90922A	Special Mack Tube	2-36	201852N	Type 8 Off-Highway Industrial Muffler, Round	4-8
90927K	U-Bolt Clamp	2-4	201853N	Type 5 Off-Highway Industrial Muffler, Round	4-6
90928K	U-Bolt Clamp	2-4	201854N	Type 2 Off-Highway Industrial Muffler, Round	4-4
90929K	U-Bolt Clamp	2-4	201855N	Type 8 Off-Highway Industrial Muffler, Round	4-8
90938A	Special Ford Turbo Adapter	2-30	201858N	Type 8 Off-Highway Industrial Muffler, Round	4-8
90956A	Special Kenworth Turbo Adapter	2-35	201859N	Type 5 Off-Highway Industrial Muffler, Round	4-6
90962A	Special Navistar Vertical Stack Pipe	2-34	900003A	Stainless Steel AccuSeal Single Bolt Pipe Clamp	2-5
90966A	Special International/Navistar Tube	2-33	900004A	Stainless Steel AccuSeal Single Bolt Pipe Clamp	2-5
90967A	Special International/Navistar Tube	2-33	900005A	Universal Muffler Hanger	2-46
90976C	Heat Guard, Stainless Steel 1/2 Wrap	2-43	900019A	Stainless Steel AccuSeal Single Bolt Pipe Clamp	2-5
90979A	Special Kenworth Elbow	2-35	900022C	Stack Support Bracket for "Monster" Stacks	2-45
90979C	Special Kenworth Chrome Pipe	2-35	900035C	Chrome Plated "Monster" Stack	2-42
90980A	Special Kenworth Elbow	2-35	900040K	U-Bolt Clamp	2-4
90980C	Special Kenworth Chrome Pipe	2-35	900041K	U-Bolt Clamp	2-4
90981A	Special Kenworth Wye Pipe	2-35	900042K	U-Bolt Clamp	2-4
90983A	Special Freightliner Tube	2-31	900043K	U-Bolt Clamp	2-4
90984C	Special Freightliner Chrome Pipe	2-31	900044K	U-Bolt Clamp	2-4
90987A	Special Freightliner Tube	2-31	900046A	Aluminized 90° Elbow	2-24
90993A	Special Peterbilt Wye Pipe	2-36	900048A	Aluminized 90° Elbow	2-24
200238N	Type 1 Muffler, Round	3-6	900050A	Aluminized 90° Elbow	2-24
200445N	Type 1 Muffler, Round	3-5	900052A	Aluminized 90° Elbow	2-24
200555N	Type 1 Muffler, Round	3-6	900053A	Aluminized 90° Elbow	2-24
200773N	Type 5 Muffler, Round	3-15	900055A	Aluminized 90° Elbow	2-24
200822N	Type 8 Muffler, Round	3-21	900056A	Aluminized 90° Elbow	2-24
201550N	Type 1 Off-Highway Industrial Muffler, Round	4-3	900057A	Aluminized 90° Elbow	2-25
201551N	Type 2 Off-Highway Industrial Muffler, Round	4-4	900058A	Aluminized 90° Elbow	2-22
201552N	Type 7 Off-Highway Industrial Muffler, Round	4-7	900059A	Aluminized 90° Elbow	2-22
201553N	Type 3 Off-Highway Industrial Muffler, Round	4-5	900062A	Aluminized 90° Elbow	2-22
201554N	Type 8 Off-Highway Industrial Muffler, Round	4-8	900063A	Aluminized 90° Elbow	2-22
201555N	Type 1 Off-Highway Industrial Muffler, Round	4-3	900068A	Aluminized 45° Elbow	2-20
201556N	Type 2 Off-Highway Industrial Muffler, Round	4-4	900072A	Aluminized 30° Elbow	2-20
201557N	Type 7 Off-Highway Industrial Muffler, Round	4-7	900073A	Aluminized 30° Elbow	2-20
201558N	Type 3 Off-Highway Industrial Muffler, Round	4-5	900074A	Aluminized 30° Elbow	2-20
201559N	Type 8 Off-Highway Industrial Muffler, Round	4-8	900076A	Aluminized 30° Elbow	2-20
201560N	Type 1 Off-Highway Industrial Muffler, Round	4-3	900077A	Aluminized 30° Elbow	2-20
201561N	Type 2 Off-Highway Industrial Muffler, Round	4-4	900078A	Aluminized 30° Elbow	2-20
201562N	Type 7 Off-Highway Industrial Muffler, Round	4-7	900080A	Aluminized 60° Elbow	2-21
201563N	Type 3 Off-Highway Industrial Muffler, Round	4-5	900081A	Aluminized 60° Elbow	2-21
201564N	Type 8 Off-Highway Industrial Muffler, Round	4-8	900082A	Aluminized 60° Elbow	2-21
201565N	Type 1 Off-Highway Industrial Muffler, Round	4-3	900084A	Aluminized 60° Elbow	2-21
201566N	Type 2 Off-Highway Industrial Muffler, Round	4-4	900085A	Aluminized 60° Elbow	2-21
201567N	Type 7 Off-Highway Industrial Muffler, Round	4-7	900086A	Aluminized 60° Elbow	2-21
201568N	Type 3 Off-Highway Industrial Muffler, Round	4-5	900088A	Curved Stack Pipe	2-38, 2-40
201569N	Type 8 Off-Highway Industrial Muffler, Round	4-8	900088C	Curved Stack Pipe	2-38, 2-40
201570N	Type 1 Off-Highway Industrial Muffler, Round	4-3	900089C	Curved Stack Pipe	2-38
201571N	Type 2 Off-Highway Industrial Muffler, Round	4-4	900090C	Curved Stack Pipe	2-38
201572N	Type 7 Off-Highway Industrial Muffler, Round	4-7	900091A	Aluminized Dump Truck Stack Pipe	2-41
201573N	Type 3 Off-Highway Industrial Muffler, Round	4-5	900092C	Chrome Plated "Monster" Stack	2-42
201574N	Type 8 Off-Highway Industrial Muffler, Round	4-8	900093C	Chrome Plated "Monster" Stack	2-42
201575N	Type 1 Off-Highway Industrial Muffler, Round	4-3	900094C	Chrome Plated "Monster" Stack	2-42
201576N	Type 2 Off-Highway Industrial Muffler, Round	4-4	900098A	Aluminized 90° Elbow	2-22
201577N	Type 7 Off-Highway Industrial Muffler, Round	4-7	900099A	Aluminized 90° Elbow	2-23
201578N	Type 3 Off-Highway Industrial Muffler, Round	4-5	900100A	Aluminized 45° Elbow	2-20
201579N	Type 8 Off-Highway Industrial Muffler, Round	4-8	900121A	Aluminized "Y" Pipe	2-36
201843N	Type 8 Off-Highway Industrial Muffler, Round	4-8	900123A	Special Western Star Exhaust Pipe	2-36

900134A	Type 3 Flared Connecto	2-11	925070A	Special International/Navistar Tube	2-34
900162A	Aluminized 30° Elbow	2-20	925071A	Special International/Navistar Tube	2-34
900273A	Wide Band ValuSeal Clamp	2-6	926005A	Special International/Navistar Tube	2-32
900357K	Galvanized Flex Tubing, Cut to Length	2-18	926008A	Special International/Navistar Tube	2-34
900358K	Galvanized Flex Tubing, Cut to Length	2-18	926011A	Special Ford Tube	2-30
900359K	Galvanized Flex Tubing, Cut to Length	2-18	926062A	Special International/Navistar Tube	2-33
900503A	Flared Adapter, Marmon	2-16	926072A	Special International/Navistar Tube	2-32
900504A	Flared Adapter, Marmon	2-16	927010A	Special International/Navistar Tube	2-32
900505A	Flared Adapter, Marmon	2-16	928011C	Chrome Curved Stack Pipe	2-39
900509A	Flared Adapter, Marmon	2-16	929001A	Special International/Navistar Tube	2-32
900510A	Flared Adapter, Marmon	2-16	929011A	Special International/Navistar Tube	2-32
900511A	Flared Adapter, Marmon	2-16	929012A	Special GMC Tube	2-31
900515A	Weld Connector, Stainless Steel	2-15	929016A	Special International/Navistar Tube	2-32
900516A	Weld Connector, Stainless Steel	2-15	929038A	Special International/Navistar Tube	2-32
900517A	Weld Connector, Stainless Steel	2-15	A029T534	V-Band Clamp, Marmon	2-16
900521A	High Performance Flex Tube	2-29	A029T535	V-Band Clamp, Marmon	2-16
900522A	High Performance Flex Tube	2-29	A030F890	Slotted Stack Exhaust Diffuser	2-44
900523A	High Performance Flex Tube	2-29	A030F891	Slotted Stack Exhaust Diffuser	2-44
900527A	Stainless Steel 90° Elbow	2-26	A030F892	Slotted Stack Exhaust Diffuser	2-44
900528A	Stainless Steel 90° Elbow	2-26	A030F893	Slotted Stack Exhaust Diffuser	2-44
900529A	Stainless Steel 90° Elbow	2-26	Q02702A	Band Clamp	4-10
900533A	Stainless Steel 45° Elbow	2-26	Q02737A	Band Clamp	4-10
900534A	Stainless Steel 45° Elbow	2-26	Q02764A	Band Clamp	4-10
900535A	Stainless Steel 45° Elbow	2-26	Q02765A	Band Clamp	4-10
900539A	Straight Tubing, Stainless Steel	2-29	Q25344	Custom Length Stack, Black	2-41
900540A	Straight Tubing, Stainless Steel	2-29	Q26688	Custom Length Stack, Black	2-41
900541A	Straight Tubing, Stainless Steel	2-29	Q27074A	Foo	4-10
900542A	Expander with Clamp Connection	2-17	Q42088	Custom Length Stack, Black	2-41
900543A	Expander with Clamp Connection	2-17	Q42089	Custom Length Stack, Black	2-41
900544A	Expander with Clamp Connection	2-17	Q42097	Custom Length Stack, Black	2-41
900545A	Expander with Clamp Connection	2-17	Q42331	Custom Length Stack, Black	2-41
900546A	Expander with Clamp Connection	2-17	Q100650	Tube Adapter	4-9
900547A	Expander with Clamp Connection	2-17	Q100651	Tube Adapter	4-9
900551A	Stainless Steel 90° Elbow	2-26	Q186201	Mild Steel Mounting Band	2-48
900552A	Stainless Steel 90° Elbow	2-26	Q186286	Mild Steel Mounting Band	2-48
900553A	Stainless Steel 90° Elbow	2-26	Q186516	Mild Steel Mounting Band	2-48
900557A	Stainless Steel 90° Elbow	2-26	Q186787	U-Bolt Clamp	4-10
900558A	Stainless Steel 90° Elbow	2-26	Q186788	U-Bolt Clamp	4-10
900559A	Stainless Steel 90° Elbow	2-26	Q186790	U-Bolt Clamp	4-10
900563A	Stainless Steel Clamp Connector	2-15	Q187033A	Body Clamp	4-10
900564A	Stainless Steel Clamp Connector	2-15	Q187034A	Body Clamp	4-10
900565A	Stainless Steel Clamp Connector	2-15	Q187035A	Body Clamp	4-10
900570A	High Performance Flex Tube with Retention Liner	2-29	Q187037	U-Bolt Clamp	4-10
900571A	High Performance Flex Tube with Retention Liner	2-29	Q187038	U-Bolt Clamp	4-10
900572A	High Performance Flex Tube with Retention Liner	2-29	Q312516	V-Band Gasket	2-16
900573A	Stainless Steel 90° Elbow	2-26	Q312526	V-Band Gasket	2-16
900574A	Stainless Steel 90° Elbow	2-26	Q312541	V-Band Gasket	2-16
900575A	Stainless Steel 90° Elbow	2-26	Q618142	Freightliner Century Series Elbow	2-27
923008A	Special Ford Exhaust Pipe	2-30	Q629839	Slotted Stack Exhaust Diffuser U-bolt Clamp	2-44
923042A	Special Bluebird Tail Pipe	2-30	Q645633	Zinc Plated Mild Steel Curved Stack Pipe, Slotted & Expanded	2-38
924004A	Special Ford Exhaust Pipe	2-30	Q646112	Stack Pipe for Ag/Construction	2-38
924005A	Special Bluebird Exhaust Pipe	2-30	Q650812	45° Tail Pipe	4-9
924008A	Special International/Navistar Exhaust Pipe	2-34	Q650813	45° Tail Pipe	4-9
924027A	Special GMC Tail Pipe	2-31	Q650815	45° Tail Pipe	4-9
924037A	Special Bluebird Tail Pipe	2-30	Q650822	90° Tail Pipe	4-9
924072C	Chrome Plated "Monster" Stack	2-42	Q650823	90° Tail Pipe	4-9
925002A	Special GMC Over Axle Bus Pipe	2-31	Q650825	90° Tail Pipe	4-9
925005A	Special International/Navistar Tube	2-33	Q668167	45° Tail Pipe	4-9
925014A	Special International/Navistar Tube	2-34	Q668168	45° Tail Pipe	4-9
925051A	Aluminized Curved Stack Pipe	2-38, 2-40	Q668169	45° Tail Pipe	4-9
925051C	Chrome Curved Stack Pipe, Slotted	2-38, 2-40	Q668170	90° Tail Pipe	4-9
925066A	Special International/Navistar Tube	2-33	Q668171	90° Tail Pipe	4-9
925068A	Special International/Navistar Tube	2-33	Q668172	90° Tail Pipe	4-9

Index

Q704762	Straight Tail Pipe	4-9
Q704763	Straight Tail Pipe	4-9
Q704765	Straight Tail Pipe	4-9
Q714122	Straight Tail Pipe	4-9
Q714123	Straight Tail Pipe	4-9
Q714124	Straight Tail Pipe	4-9





The name to know...
the technology to trust

Nelson Global Products Locations

Arcadia, Wisc.

1450 E. Wilson Avenue
Arcadia, WI 54612

Black River Falls, Wisc.

915 Red Iron Road
Black River Falls, WI 54615

Clinton, Tenn.

Southern Tube Form
130 Eagle Way
Clinton, TN 37716

Fort Wayne, Ind.

National Tube Form
3405 Engle Road
Fort Wayne, IN 46809

Morton, Ill.

Morton Industries, LLC
70 Commerce Drive
Morton, IL 61550

Bradley Services, Inc.
935 Detroit Ave.
Morton, IL 61550

Peoria, Ill.

Peoria Tube
1331 Spring Bay Road
East Peoria, IL 61611

Stoughton, Wisc.
Nelson Global Products
P.O. Box 511
1801 US Hwy 51/138
Stoughton, WI 53589

Viroqua, Wisc.

1202 Nelson Pkwy.
Viroqua, WI 54665

Baraboo, Wisc.

1515 Walnut Street
Baraboo, WI 53913

Australia

48 Koornang Road, Scoresby
Scoresby VIC 3179, Australia

China

Pacific (Changzhou) Tubing Co. Ltd.
#9 – GDH Changzhou Airport Ind. Park
No. 388 West Huanghe Road
Xinbei District
Changzhou, Jiangsu, PRC 213000

India - Daman

Nelson Global Products India Ltd.
Survey no 74/3 & 4, Part 11
Village Kadaiya
Nani Daman, Daman
India 396210

India – Pune Office

Nelson Global Products India Ltd.
Office No. 2, Kapil Complex
S.N. 82/1/2 Baner Road
Near Orchid School
Baner, Pune
India 411045



Nelson Global Products
P.O. Box 511
Stoughton, WI 53589

NGP005 Rev. 2
Printed in U.S.A 1/13
©2012-2013 Nelson Global Products, Inc.